

**AGENDA**  
**CITY OF STEVENSON COUNCIL MEETING**  
**March 16, 2023**  
**6:00 PM, City Hall and Remote**

Call-in numbers 253-215-8782, 669-900-6833, 346-248-7799, 312-626-6799, 929-205-6099 or 301-715-8592, Meeting ID 889 7550 7011, Zoom link <https://us02web.zoom.us/j/88975507011> or via YouTube at <https://www.youtube.com/channel/UC4k9bA0IEEvsF6PSoDwjJvA/>

---

Items with an asterisk (\*) have been added or modified after the initial draft publication of the Agenda.

**1. CALL TO ORDER/PRESENTATION TO THE FLAG:** Mayor to call the meeting to order, lead the group in reciting the pledge of allegiance and conduct roll call.

**2. PUBLIC COMMENTS:** *[This is an opportunity for members of the audience to address the Council. If you wish to address the Council, please sign in to be recognized by the Mayor. Comments are limited to three minutes per speaker. The Mayor may extend or further limit these time periods at his discretion. The Mayor may allow citizens to comment on individual agenda items outside of the public comment period at his discretion. Please submit written comments to City Hall in person at 7121 E. Loop Rd, via mail to PO Box 371, Stevenson, WA 98648 or via email to [leana@ci.stevenson.wa.us](mailto:leana@ci.stevenson.wa.us) by noon the day of the meeting for inclusion in the council packet.]*

**3. CHANGES TO THE AGENDA:** *[The Mayor may add agenda items or take agenda items out of order with the concurrence of the majority of the Council].*

a) \* 3/14 changes include:

- Added Special Occasion Liquor License for Friends of the Library (item 4c)
- Added Environmental Mitigation Agreement (item 7e)
- Added Personnel Policy Revision (item 7f)
- Addition of Vouchers (item 11a)

**4. CONSENT AGENDA:** The following items are presented for Council approval. *[Consent agenda items are intended to be passed by a single motion to approve all listed actions. If discussion of an individual item is requested by a Council member, that item should be removed from the consent agenda and considered separately after approval of the remaining consent agenda items.]*

a) **Water Adjustment** - Carolyn Gailey (meter No. 600500) requests a water adjustment of \$65.81 for a water leak which they have since repaired.

- b) **Water Adjustment** - Fernando and Margie Hidalgo (meter No. 605500) requests a water adjustment of \$1,000 for a water leak which they have since repaired.
- c) **\*Special Occasion Liquor license application** - Friends of the Stevenson/N. Bonneville Libraries at the Stevenson Library on October 7th from 6pm-8pm.
- d) **Minutes** of February 16, 2023 regular meeting and March 8, 2023 special workshop.

MOTION: To approve consent agenda items a-d.

#### 5. SITUATION UPDATES:

- a) **Sewer Plant Update** - Staff will present an update on the Stevenson Wastewater System and Compliance Schedule.

#### 6. UNFINISHED BUSINESS:

- a) **Approve Type D Right of Way Permit for 725 NW Angel Heights Rd** - Public Works Director Carolyn Sourek presents the staff report and permit for the request for a Type D long-term use of the city right of way for a retaining wall at 725 NW Angel Heights Road for council consideration.

MOTION: To approve City of Stevenson Type D Right of Way Permit for 725 NW Angel Heights Rd. to build a retaining wall within City ROW, conditional upon the installation of a protective concrete collar around the sewer cleanout, replacement of the full sidewalk panel over the wall drain, and removable at parcel owner's expense if issues with any city infrastructure is observed.

#### 7. COUNCIL BUSINESS:

- a) **Approve Park Plaza Commerce Grant** - City Administrator Leana Kinley presents the attached contract from the Department of Commerce in the amount of \$147,000 to complete design and have a shovel ready Park Plaza project by the end of 2024 for council review and consideration.

MOTION: To approve the contract with Department of Commerce in the amount of \$147,000 to complete design of the Park Plaza project.

- b) **Approve Resolution Appointing a Tort Claim Administrator** - City Administrator Leana Kinley presents resolution 2023-406 appointing the City Administrator as the agent to receive claims on behalf of the city for council consideration. This appointment is required according to RCW 4.96.020(2).

MOTION: To approve resolution 2023-406 approving the appointment of the City Administrator as the agent to receive claims on behalf of the City of Stevenson.

- c) Skamania County Building Inspector Agreement Addendum #2** - City Administrator Leana Kinley presents the attached addendum #2 to the interlocal agreement for building inspection and plan review services between the City of Stevenson and Skamania County to include using Cloudpermit software services for council discussion and consideration. The annual cost will be almost \$5,600, about \$2,400 more than our current system, with greater functionality and improved efficiency.

MOTION: To approve addendum #2 to the interlocal agreement for building inspection and plan review services between the City of Stevenson and Skamania County.

- d) Discuss Council Workshop Calendar** - City Administrator Leana Kinley presents the 2023 council workshop calendar for further discussion regarding dates as there is a meeting conflict with the Fair Board and the workshops. The next meeting will be the discussion of the Strategic Plan in preparation for the 2024 budget.

- e) \*Approve Environmental Mitigation Agreement** - Public Works Director Carolyn Sourek presents the attached agreement extending the sewer line along NW Iman Cemetery Road for discussion and council consideration. This allows the city to pay for the property owner to extend the sewer line farther than they are required to by law in order to incrementally address the expansion of sewer into the area. The city will only pay its proportionate share of the cost.

MOTION: To approve the environmental mitigation agreement with Adam Miller to extend the sewer line along NW Iman Cemetery Road as presented.

- f) \*Approve Personnel Policy Update** - Public Works Director Carolyn Sourek presents resolution 2023-407 revising the personnel policy for council consideration. The changes update the job descriptions for the Wastewater Treatment Plant Operator II and III for certification consistency and clarification of duties.

MOTION: To approve resolution 2023-407 revising the personnel policy.

## 8. INFORMATION ITEMS:

- a) Sheriff's Report** - The Skamania County Sheriff's report for activity within Stevenson city limits for the prior month is presented for council review.
- b) Financial Report** - The Treasurer's Report and year-to-date revenues and expenses through the prior month are presented for council review.
- c) Housing Programs Report** - The report for the prior month on housing services provided by Washington Gorge Action Programs in Skamania County is enclosed for council information.

## 9. CITY ADMINISTRATOR AND STAFF REPORTS:

- a) Carolyn Sourek, Public Works Director
- b) Leana Kinley, City Administrator

**10. VOUCHER APPROVAL:**

- a) \*February 2023 payroll, and March 2023 AP checks have been audited and are presented for approval. February payroll checks 16714 thru 16718 total \$123,043.36 which includes EFT payments. March 2023 AP checks 16712, 16713 and 16719 thru 16785 total \$1,187,940.66, which includes EFT payments. The AP check register with fund transaction summary is attached for review.

MOTION: To approve the vouchers as presented.

**11. MAYOR AND COUNCIL REPORTS:**

**12. ISSUES FOR THE NEXT MEETING:** *[This provides Council Members an opportunity to focus the Mayor and Staff's attention on issues they would like to have addressed at the next council meeting.]*

**13. ADJOURNMENT** - Mayor will adjourn the meeting.

=====

**UPCOMING MEETINGS AND EVENTS:**

- Monday, March 20, 2023 6pm Board of Adjustments Variance Hearing
- Monday, April 10, 2023 6pm Planning Commission Meeting
- Wednesday, April 12, 2023 6pm Special Council Workshop on 2024 Priorities
- Thursday, April 20, 2023 6pm Regular Council Meeting



**MINUTES**  
**CITY OF STEVENSON COUNCIL MEETING**  
**February 16, 2023**  
**6:00 PM, City Hall and Remote**

---

1. **CALL TO ORDER/PRESENTATION TO THE FLAG:** Mayor Anderson called the meeting to order at 6:00 p.m, led the group in reciting the pledge of allegiance and conducted roll call.

**Elected officials in attendance:** Mayor Scott Anderson; Councilmembers Dave Cox, Michael Johnson, Kristy McCaskell, David Wyatt, Paul Hendricks.

**Staff attending:** City Administrator Leana Kinley; Public Works Director Carolyn Sourek, City Attorney Ken Woodrich, City Attorney Robert Muth, Fire Chief Rob Ferris.

**Guests:** Executive Director for the Stevenson Downtown Association Kelly O'Malley-McKee; Skamania County Undersheriff Tracy Wyckoff, Skamania County Sheriff Summer Scheyer, Skamania County Assistant Fire Marshal Arnold Bell.

**Public attendees:** Ann and Ray Leuders, Mary Repar, Laura Graves.

2. **PUBLIC COMMENTS:**

>Mary Repar commented on city trees, Bridge of the Gods toll usage, and recent Shoreline Planning efforts within the city.

3. **CHANGES TO THE AGENDA:**

a) **2/14 changes include:**

- Added Karen Ashley Water Leak Adjustment Request (item 5e)
- Added Liquor License Renewals for A&J and Hotel Stevenson (item 5f)
- Revised Minutes to clarify storm water issues will be discussed at the May council meeting (item 5g)
- Added staff report to Sewer Update (item 7a)
- Added Year End update report to 2023 Budget Amendment (item 8i)
- Added Attorney Services Contract (item 8j)
- Added Type D Right of Way Request (item 8k)
- Added Housing Programs Report (item 9d)
- Removed Ben Shumaker from staff reports (formerly item 10a)
- Addition of Vouchers (item 11a)

4. **SHERIFF'S OFFICE REPORT:**

- a) **Sheriff's Report** - Undersheriff Tracy Wyckoff presented reports for activity within Stevenson city limits for the prior two months.

## 5. CONSENT AGENDA:

- a) **Liquor License Renewal** - Backwoods Brewing Company
- b) **Water Adjustment** - Mike Rankin (meter No. 203850) requests a water adjustment of \$385.76 for a water leak which has since been repaired.
- c) **Water Adjustment** - Sharon Madsen's estate (meter No. 703700) requests a water adjustment of \$616.22 for a water leak which has since been repaired.
- d) **Water Adjustment** - Wilder and Pines Riverside Cabins (meter No. 509070) requests a water adjustment of \$1,000 for a water leak which has since been repaired.
- e) **\*Water Adjustment** - Karen Ashley (meter No. 504500) requests a water adjustment of \$75.54 for a water leak which has since been repaired.
- f) **\*Liquor License Renewals** - A&J Stores, Inc. and Hotel Stevenson LLC
- g) **\*Minutes** of January 19th regular council meeting and February 9th council workshop.

**MOTION** to approve consent agenda items a-g was made by **Councilmember Hendricks**, seconded by **Councilmember Johnson**.

Voting aye: **Councilmembers Cox, McCaskell, Hendricks, Johnson, Wyatt**.

## 6. PRESENTATIONS FROM OUTSIDE AGENCIES:

- a) **Stevenson Downtown Association Presentation** - Executive Director for the Stevenson Downtown Association Kelly O'Malley-McKee, provided an update on the association and its accomplishments over the past year. She noted several planning grants received and reported over 1,200 hours of volunteer time was tallied.

## 7. SITUATION UPDATES:

- a) **Sewer Plant Update – Public Works Director Carolyn Sourek** presented an update on the Stevenson Wastewater System and Compliance Schedule. The project's completion date has been pushed back almost a year, and she is in discussion with the construction management firm regarding options to shorten the timeline. Improvements to the collection system are nearly complete, and the three pump station designs are finishing up.

**Mayor Anderson** commented the delay in completion was affecting commercial sewer connections.

## 8. COUNCIL BUSINESS:

- a) **Fireworks Discussion - City Administrator Leana Kinley** presented and explained information from the January 21, 2021 public hearing on the matter, which included results from an online survey, public comments regarding fireworks use inside city limits, and a copy of the minutes from the former meeting for further discussion. A new memo from **Rob Farris, Fire Chief** was also included. After discussion, the matter will be reviewed at the April council workshop for inclusion into the Strategic Plan for possible future engagement and action.

**Mayor Anderson** called for a change in the agenda order to address item 8j:

- j) **Approve Contract for City Attorney - City Administrator Leana Kinley** presented a contract with Robert Muth for city attorney services for council consideration.

**MOTION** to approve the contract with Robert Muth for city attorney services as presented was made by **Councilmember Cox**, seconded by **Councilmember Hendricks**.

Voting aye: **Councilmembers Cox, McCaskell, Hendricks, Johnson, Wyatt**.

- b) **Skamania County Incarceration Services Agreement - City Administrator Leana Kinley** presented and explained the 2022-23 contract with Skamania County for Incarceration services for council approval. A contract for last year seems to have been missed and this contract will close that gap. There are no changes from previous contracts.

**MOTION** to approve the 2022-23 contract with Skamania County for Incarceration services was made by **Councilmember Johnson**, seconded by **Councilmember McCaskell**.

Voting aye: **Councilmembers Cox, McCaskell, Hendricks, Johnson, Wyatt**.

- c) **Skamania County Building Inspector Agreement Addendum #1 - City Administrator Leana Kinley** presented and explained the attached addendum #1 to the interlocal agreement for building inspection and plan review services between the City of Stevenson and Skamania County to include Fire Marshall services for council discussion and consideration.

**MOTION** to approve addendum #1 to the interlocal agreement for building inspection and plan review services between the City of Stevenson and Skamania County was made by **Councilmember Hendricks**, seconded by **Councilmember McCaskell**.

Voting aye: **Councilmembers Cox, McCaskell, Hendricks, Johnson, Wyatt**.

- d) **Approve Revised FireMed Radio Agreement - City Administrator Leana Kinley** presented the attached draft of the Fire/Med frequency radio users interlocal agreement on behalf of **Fire Chief Rob Farris** for council consideration. A copy of the tracked changes and a clean version of the contract were attached.

**MOTION** to approve the interlocal agreement between Skamania County and Skamania County Emergency Services Agencies was made by **Councilmember Johnson**, seconded by **Councilmember Cox**.

Voting aye: **Councilmembers Cox, McCaskell, Hendricks, Johnson, Wyatt**.

- e) **Water Adjustment** - Laura Graves requested an adjustment of \$433.30 for the sewer portion of a water leak which has since been repaired. The account was established less than six-months ago, which makes it ineligible for a leak adjustment according to the current policy. A copy of her request and the policy were attached for council consideration.

**MOTION** to approve the sewer portion of the utility bill due to a water leak at 304 SW Second St. be adjusted in the amount of \$433.30 was made by **Councilmember Hendricks**, seconded by **Councilmember Johnson**.

Voting aye: **Councilmembers Cox, McCaskell, Hendricks, Johnson, Wyatt**.

- f) **Approve Revised Transportation Improvement Board (TIB) Contract – City Administrator Leana Kinley** presented and explained a revised TIB contract for the Loop Rd. project to include design funding, an additional \$63,507, for council consideration. The project is included in the 2023 budget and the change will have no increase on the ending cash balance for the project as both revenues and expenses will be increased.

**MOTION** to approve the revised agreement 6-W-974(006)-1 with the State of Washington Transportation Improvement Board in the amount of \$523,929 to rebuild, resurface and add sidewalks along Loop Road from Columbia Ave east to the city limits was made by **Councilmember Johnson**, seconded by **Councilmember McCaskell**.

Voting aye: **Councilmembers Cox, McCaskell, Hendricks, Johnson, Wyatt**.

- g) **Approve Contracts for Asset Management System - City Administrator Leana Kinley** presented and explained on behalf of **Public Works Director Carolyn Sourek** the contract with Cityworks for asset management software (AMS), with a term of three years at \$14,000 for the first year and \$16,000 per year for the last two, and a proposal from Centricity in the amount of \$39,500 for implementation support for council consideration. **Public Works Director Carolyn Sourek** provided additional details on its usage with GIS systems.

**MOTION** to approve the three-year contract with Cityworks for asset management software in the amount of \$14,000 for the first year and \$16,000 for the last two years was made by **Councilmember Hendricks**, seconded by **Councilmember Johnson**.

Voting aye: **Councilmembers Cox, McCaskell, Hendricks, Johnson, Wyatt.**

**MOTION** to approve the proposal from Centricity for AMS implementation/consultant support in the amount of \$39,500 was made by **Councilmember Hendricks**, seconded by **Councilmember McCaskell**.

Voting aye: **Councilmembers Cox, McCaskell, Hendricks, Johnson, Wyatt.**

**h) Strategic Plan Q1 2023 Update - City Administrator Leana Kinley** presented the update to the Strategic Plan established in 2022.

**City Attorney Woodrich** excused himself and asked **City Attorney Muth** to fill in for the remainder of the meeting.

**i) Proposed 2023 Budget Amendments - City Administrator Leana Kinley** presented proposed changes to the 2023 budget based on revised estimates due to changes in beginning cash balances, updating project costs for the Columbia Realignment project, updating project revenues based on revised funding estimates for the wastewater upgrades fund, and rolling-over the expenses for the preliminary design and engineering on the Park Plaza project. The ordinance needs to be passed and cannot wait for a second reading as it is holding up the state funding contract for the direct appropriation for the park plaza project.

**MOTION** to approve ordinance 2023-1193 amending the 2023 budget was made by **Councilmember Cox**, seconded by **Councilmember Johnson**.

Voting aye: **Councilmembers Cox, McCaskell, Hendricks, Johnson, Wyatt.**

**j)** This item was moved and addressed earlier in the meeting.

**k) \*Approve Type D Right of Way Permit for 725 NW Angel Heights Rd – Public Works**  
**Director Carolyn Sourek** presented and explained the staff report regarding the request for a Type D long-term use of the city right-of-way permit for a retaining wall at 725 NW Angel Heights Road for council consideration.

Council tabled the issue. **Councilmember Hendricks** requested the homeowners attend a meeting and provide more information.

**9. INFORMATION ITEMS:** The following items were presented for Council consideration.

**a) Financial Report -** The Treasurer's Report and year-to-date revenues and expenses through the prior month were presented for council review.

**b) Planning Commission Minutes -** No minutes were presented as there was no Planning Commission meeting in January 2023.

- c) **Contracts Awarded Administratively** - The report on contracts, purchases and change orders over \$10,000 approved administratively over the past month was attached.
- d) **\*Housing Programs Report** - The report for the prior months on housing services provided by Washington Gorge Action Programs in Skamania County was enclosed for council information.

**10. CITY ADMINISTRATOR AND STAFF REPORTS:**

**a) Public Works Director Carolyn Sourek**

- i. The City is partnering with the PUD to place a needed culvert on Monda Road to divert excess water runoff.
- ii. Several grants have been awarded to use for improved way-finding signage. She is applying for a grant for sidewalk repair.
- iii. The City is continuing to evaluate recommendations on tree removal provided by a recent tree inventory report.
- iv. New vehicles are in use. Within a year or so the next item to replace will be the sweeper.

**b) Leana Kinley, City Administrator**

- i. Columbia Avenue realignment project is facing challenges due to current parking requirements. The requirements will be reviewed regarding possible changes.
- ii. The Port of Cascade Locks recently passed a resolution stating the Bridge of the Gods will only use tolls to fund bridge operations starting in 2030. \$6M from both the Oregon and Washington legislature has been requested to study seismic retrofits. Washington is looking to direct all its funds through a Washington agency in order to ensure they are spent only on this project. A bridge authority to oversee operations may be considered in the future.

**11. VOUCHER APPROVAL:**

- a) \*January 2023 payroll, December 2022 13th month payroll, and February 2023 AP checks have been audited and were presented for approval. January payroll checks 16650 thru 16652 total \$112,488.06 included EFT payments. December 2022 13th month payroll EFT payments total \$4,435.75. February 2023 AP checks 16649 and 16653 thru 16711 total \$1,314,560.48, included EFT payments. The AP check register with fund transaction summary was attached for review.

**MOTION** to approve the vouchers as presented was made by **Councilmember Hendricks**, seconded by **Councilmember McCaskell**.

Voting aye: **Councilmembers Cox, McCaskell, Hendricks, Johnson, Wyatt**.

**12. MAYOR AND COUNCIL REPORTS:**

- a) **Mayor Anderson** reported the recent Shoreline Access project meeting showed positive momentum, with good buy in from stakeholders. It was understood by those attending the goal is to ultimately develop a trail system.
- b) Spruce Up Stevenson will take place the first Saturday in May. Volunteers are needed.
- c) **Councilmember Cox** walked around the stormwater retention area at Angel Heights. He initiated a short discussion on brush and vegetation removal of the area, and asked if the city could potentially help dispose of the green waste.
- d) **Councilmember Cox** voiced appreciation to Johanna Roe for her work on the minutes.

**13. ISSUES FOR THE NEXT MEETING:** No issues were noted.

**14. ADJOURNMENT - Mayor Anderson** adjourned the meeting at 8:37 p.m.

---

Scott Anderson, Mayor

Date

**MINUTES**  
**CITY OF STEVENSON SPECIAL COUNCIL WORKSHOP**  
**March 08, 2023**  
**6:00 PM, City Hall and Remote**

---

**1. CALL TO ORDER:** Mayor Anderson called the meeting to order at 6:03pm.

**PRESENT**

Councilmember Dave Cox  
Councilmember Kristy McCaskell  
Councilmember Michael D. Johnson  
Councilmember David Wyatt  
City Administrator Leana Kinley

**ABSENT**

Councilmember Paul Hendricks

**2. PUBLIC COMMENTS:** None

**3. COUNCIL BUSINESS:**

- a) **AWC Webinar:** Public Records Act eLearning customized for city councilmembers and mayors to help meet an important training requirement of the Open Government Trainings Act. There are no additional materials with this training.

**4. ADJOURNMENT** - Mayor Anderson adjourned the meeting at 6:58pm.

---

Scott Anderson, Mayor

Date





# City of Stevenson

Phone (509)427-5970  
FAX (509) 427-8202

7121 E Loop Road, PO Box 371  
Stevenson, Washington 98648

To: Stevenson City Council  
From: Carolyn Sourek, Public Works Director  
RE: Sewer Plant Update  
Meeting Date: March 16, 2023

## **Executive Summary:**

This is an overview of items staff has been working on over the past month in line with the direction council gave to staff.

## **Overview of Items:**

The plant continues to operate within its permit limits for total suspended solids (TSS), biochemical oxygen demand (BOD), and bacteria for its effluent.

The WWTP Plant Upgrade project is nearing completion of the concrete pours of the anoxic basin. They are also working on forming and rebar for the new UV chamber. Due to material acquisition delays (specifically the automatic transfer switch and the mechanical control center for the fine bubbler diffusers) the substantial completion date for this project has been adjusted to August 28, 2024.

The City met with Department of Ecology (DOE) on Monday, March 6, 2023, to discuss how the WWTP Plant Upgrade schedule change may affect local economy if the current City moratorium on new sewer connections continues to remain in place. Both City staff and DOE representatives acknowledged potential economical impacts associated with retaining the moratorium as currently written. DOE shared some thoughts on how the City could mitigate risk associated with any proposed language change to the moratorium, in light of the change to the schedule. City staff will work with DOE and consultant technical experts, Wallis Engineering, to present to Counsel at the next meeting, any options available to reduce potential economic impacts to the City.

Only punchlist items remain for the contractor to complete the 2021 Collection System Improvements Project.

The City expects to receive 90% design plans for the Kanaka, Cascade, and Fairgrounds pump stations this week (if we haven't already). We anticipate this project being advertised in May for construction in 2023.

The sewer mainline under Cascade Ave was identified as being undersized in the General Sewer Plan. Consultant engineer, Greyling Engineers, has prepared a draft Preliminary Engineering Report (PERS) outlining known issues and propose costs for repair and replacement of sewer mainline, as well as deficient, adjacent water line, and street improvements (streetlights and stormwater collection). The initial project cost estimate is \$2M for all proposed improvements. The City is seeking funding for this project and hopes to construct in 2024.

We continue to wait for warmer weather and the return of the clarifier fish.

**Plant Operations:**

The average monthly Influent BOD load since 2008 is in the chart below.

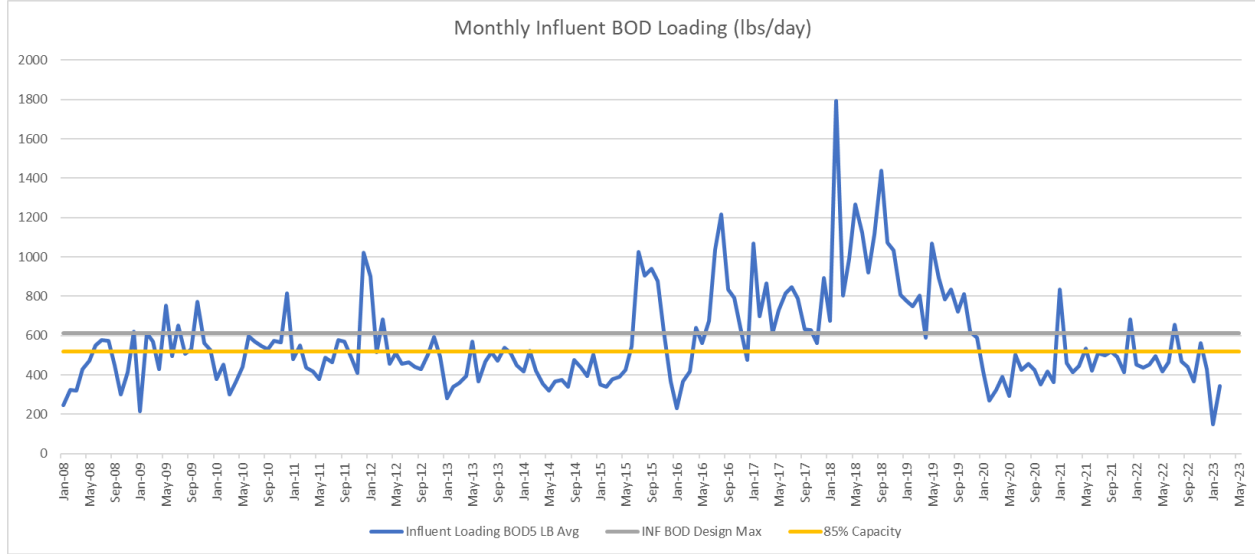

The current permit limit for Influent is 612 lbs/day and the current upgrades in the adopted General Sewer Plan call for a design max monthly BOD loading of 1,611 lbs/day.

**Funding:**

The \$2.5M in direct federal appropriations requested spring of 2021 is moving forward. The application has been submitted and we are waiting for EPA review and a contract. As soon as the process is completed, we can be reimbursed for the work. Due to the increased cost for the WWTP project, the \$2.5M in funds will allow us to hold off on requesting additional loan funds as long as possible.

	Budget	Loan	Forgivable Principal	Grant
WW Upgrades Design	2,000,000	960,000	400,000	
WW Collection System Upgrades	5,100,000	873,000		4,125,000
WW Treatment Plant Construction	12,100,000	8,700,000	900,000	2,500,000
Main D Extension	300,000	270,000	30,000	
<b>Totals:</b>	<b>19,500,000</b>	<b>10,803,000</b>	<b>1,330,000</b>	<b>6,625,000</b>
Amount of Funding:	41% Grant and Forgivable Principal			
Loan terms:	DOE Loan 1: 2.0% interest, 20-years, \$61k est. annual payment DOE Loan 2: 1.5% interest, 30-years, \$375k est. annual payment USDA Loan: 1.375% interest, 40-years, \$29k est. annual payment			

**Action Needed:**

None.



*City of Stevenson*  
Carolyn Sourek, Public Work Director

Phone (509)427-5970  
FAX (509) 427-8202

7121 E Loop Road, PO Box 371  
Stevenson, Washington 98648

To: City Council  
From: Carolyn Sourek, Public Work Director  
RE: 725 NW Angel Heights Road  
Meeting Date: March 16, 2023

**Executive Summary:**

The owners of parcel 03073633011900, Derek and Glenna Girtle, have requested a Type D Right Of Way permit to allow them to retain a rock wall construction within the City of Stevenson Right of Way (ROW) at 725 Angel Heights Road.

**Overview of Items:**

Figure 1 is a cross section of Angel Heights Road, near at the subject parcel, looking south. Angel Heights Road is currently classified as a Local Street, defined in Stevenson Engineering Standards (SES) under Volume 1, Chapter 2.00(D) as “designed specifically to have high accessibility and to connect collector and arterial roads, and are typically not used for through traffic.”

*Figure 1 – Angel Heights Road Looking South*



Per Table 2.03A of the SES Volume 1, local streets should have a total ROW width of 50 ft, with 28 ft of pavement, including (2) 10 ft drive lanes, and (1) 8 ft parking lane. Additionally, within the ROW should be (1) 6 ft minimum sidewalk, and (1) 3 ft wide planter strip.

The subject parcel is located at the end of Angel Heights Road, the wall being within the cul-de-sac bulb section of the roadway. The ROW designated at the cul-de-sac bulb is circular, with a 50 ft radius, while



the street (with sidewalk) is constructed as a 47 ft radius, leaving an additional 3 ft of ROW from the back of sidewalk.

The straight section of Angel Heights Road at the subject parcel ROW is 60 ft, with (2) drive lanes and parking available on one of the street. Additionally, sidewalks are provided on both sides of the street. The straight segment of street (with sidewalk) is constructed as 44 ft wide, leaving an additional 8 ft of ROW from the back of sidewalk.

*Figure 2 – 725 Angel Heights Rock Wall Looking East*



*Figure 3 – 725 Angel Heights Rock Wall Looking South*



Figures 2 and 3 are photos taken of the rock wall along the subject parcel. Note the rock wall was built to the edge of sidewalk.

The parcel's sewer cleanout was installed within the ROW in the cul-de-sac section of the parcel frontage. Given the nature of the wall, the City would like to have the owner install a concrete collar as provided in City of Stevenson Standard Detail S-3.1 in Figure 4.

Figure 4 - Sewer Cleanout Concrete Collar Detail

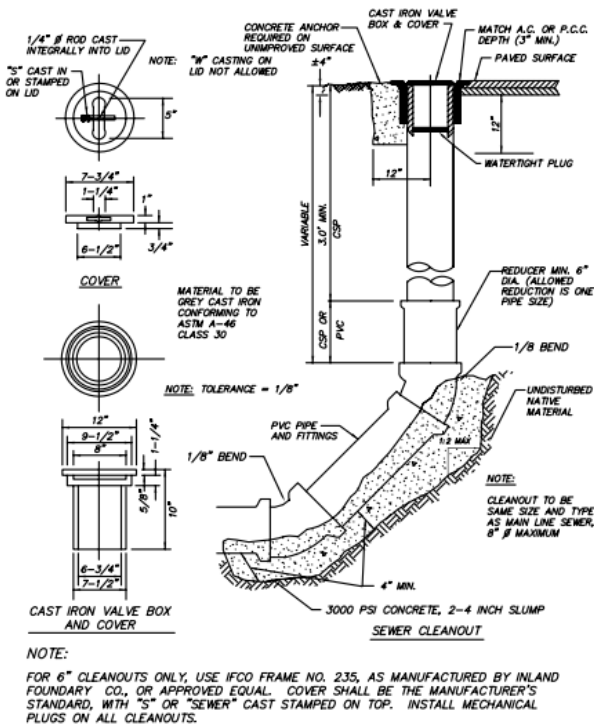

STANDARD SEWER CLEANOUT  
S-3.1

Figure 5 - Sidewalk Cut for Wall Drain



The wall drain was installed under the existing sidewalk, as shown in Figure 5 below. This item of work would typically have required a ROW permit as well. Per 12.02.060(B)(2), street restoration share require the permittee to return the public right-of-way to its original or better condition immediately upon completion of the project. The City would like to have the owner replace the concrete sidewalk panel as required per code and to City of Stevenson Engineering Standards.

Attachment 1 is a copy of Utility Plans for the Subdivision. Attachment 2 is a copy of Subdivision Survey Plans. Attachment 3 is a copy of the submitted permit application.

Chapter 12.02.060 of the Stevenson City Code establishes this type of ROW use permit as a Type D – Long-Term and Permanent Uses by Agreement and Approval by Council, as the rock wall is a “structure” that will likely have a useful life exceeding five years [12.02.060(D)(2)(a)], as well as would likely cost over one hundred dollars to remove [12.02.060(D)(2)(b)].

**Action Needed:**

Approve City of Stevenson Type D Right of Way Permit for 725 Angel Heights rock wall to remain within City ROW, conditional upon the installation of a protective concrete collar around the sewer cleanout and replacement of sidewalk panel with wall drain, and removable at parcel owner’s expense if issues with any city infrastructure is observed.



CALL  
BEFORE YOU DIG  
1-800-424-5555  
ONE CALL NUMBER  
48 HR. NOTICE REQUIRED

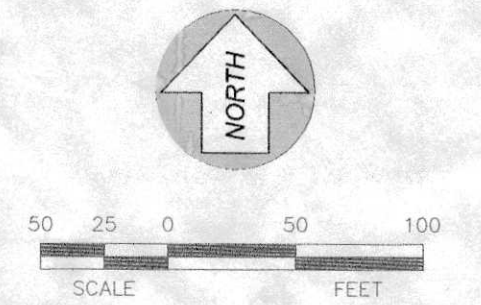

LOW AREA  
PLACE IN 8" LAYERS  
AND COMPACT TO 95%  
SUITABLE EXCAVATED  
MATERIAL FROM SITE  
FILL TO ELEVATION 282  
GRADE TO DRAIN TO CB

LIVE TAP AS DIRECTED BY CITY  
6" STAINLESS STEEL TAPPING TEE  
W/ THRUST BLOCK, 6" GATE VALVE  
AND 6"X8" REDUCER  
PER STEVENSON STD PLAN NO 5C-29

NATURAL GAS LINE

8" WATERLINE  
DUCTILE IRON, CLASS 52

NATURAL GAS LINE

45" BENDS W/  
JOINT RESTRAINT

8" CLEANOUT  
PER WSDOT  
STD PLAN B-18b  
TC 283.16  
IE 275.651

INSTALL 8"X8" TEE W/  
THRUST BLOCK, 8" GATE VALVE  
AND 8"X35" DIP (CAP END)  
FOR FUTURE EXTENSION

REMOVE AC  
UG POWER, TEL,  
TV, FIBER OPTICS

8" WATERLINE  
DUCTILE IRON, CLASS 52

ANGEL HEIGHTS  
ROAD

INSTALL 8"X8" TEE W/  
THRUST BLOCK, 8" GATE VALVE  
AND 8"X50" DIP (CAP END)  
FOR FUTURE EXTENSION

8" WATERLINE  
DUCTILE IRON, CLASS 52

ANGEL HEIGHTS  
ROAD

INSTALL 8"X8" TEE W/  
THRUST BLOCK, 8" GATE VALVE  
AND 8"X50" DIP (CAP END)  
FOR FUTURE EXTENSION

8" WATERLINE  
DUCTILE IRON, CLASS 52

ANGEL HEIGHTS  
ROAD

INSTALL 8"X8" TEE W/  
THRUST BLOCK, 8" GATE VALVE  
AND 8"X50" DIP (CAP END)  
FOR FUTURE EXTENSION

8" WATERLINE  
DUCTILE IRON, CLASS 52

ANGEL HEIGHTS  
ROAD

INSTALL 8"X8" TEE W/  
THRUST BLOCK, 8" GATE VALVE  
AND 8"X50" DIP (CAP END)  
FOR FUTURE EXTENSION

8" WATERLINE  
DUCTILE IRON, CLASS 52

ANGEL HEIGHTS  
ROAD

INSTALL 8"X8" TEE W/  
THRUST BLOCK, 8" GATE VALVE  
AND 8"X50" DIP (CAP END)  
FOR FUTURE EXTENSION

8" WATERLINE  
DUCTILE IRON, CLASS 52

ANGEL HEIGHTS  
ROAD

INSTALL 8"X8" TEE W/  
THRUST BLOCK, 8" GATE VALVE  
AND 8"X50" DIP (CAP END)  
FOR FUTURE EXTENSION

8" WATERLINE  
DUCTILE IRON, CLASS 52

ANGEL HEIGHTS  
ROAD

INSTALL 8"X8" TEE W/  
THRUST BLOCK, 8" GATE VALVE  
AND 8"X50" DIP (CAP END)  
FOR FUTURE EXTENSION

8" WATERLINE  
DUCTILE IRON, CLASS 52

ANGEL HEIGHTS  
ROAD

INSTALL 8"X8" TEE W/  
THRUST BLOCK, 8" GATE VALVE  
AND 8"X50" DIP (CAP END)  
FOR FUTURE EXTENSION

8" WATERLINE  
DUCTILE IRON, CLASS 52

ANGEL HEIGHTS  
ROAD

INSTALL 8"X8" TEE W/  
THRUST BLOCK, 8" GATE VALVE  
AND 8"X50" DIP (CAP END)  
FOR FUTURE EXTENSION

8" WATERLINE  
DUCTILE IRON, CLASS 52

ANGEL HEIGHTS  
ROAD

INSTALL 8"X8" TEE W/  
THRUST BLOCK, 8" GATE VALVE  
AND 8"X50" DIP (CAP END)  
FOR FUTURE EXTENSION

8" WATERLINE  
DUCTILE IRON, CLASS 52

ANGEL HEIGHTS  
ROAD

INSTALL 8"X8" TEE W/  
THRUST BLOCK, 8" GATE VALVE  
AND 8"X50" DIP (CAP END)  
FOR FUTURE EXTENSION

8" WATERLINE  
DUCTILE IRON, CLASS 52

ANGEL HEIGHTS  
ROAD

INSTALL 8"X8" TEE W/  
THRUST BLOCK, 8" GATE VALVE  
AND 8"X50" DIP (CAP END)  
FOR FUTURE EXTENSION

ROAD CL CURVE TABLE

CURVE	LENGTH	RADIUS	DELTA	TANGENT
C1	78.57	50.00	90°01'45"	50.03
C2	157.08	100.00	89°59'55"	100.00
C3	81.68	100.00	46°47'56"	43.27

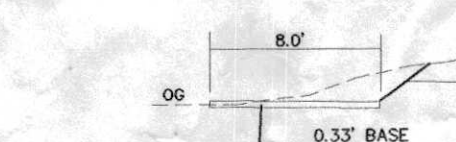

POND ACCESS ROAD CROSS SECTION  
NOT TO SCALE

NEW	EXISTING
STORM DRAIN	STORM DRAIN
WATER LINE	WATER LINE
SEWER LINE	SEWER LINE
SEWER MANHOLE	SEWER MANHOLE
SEWER CLEANOUT	SEWER CLEANOUT
STORM MANHOLE	STORM MANHOLE
CATCH BASIN	CATCH BASIN
FIRE HYDRANT	FIRE HYDRANT
VALVE	VALVE
WATER METER	WATER METER
STREET LIGHT	STREET LIGHT
CONTOUR LINE (2' INTERVAL)	CONTOUR LINE (2' INTERVAL)
TREE	TREE
POWER POLE	POWER POLE
ASPHALT STREET	ASPHALT STREET
ASPHALT PATHWAY	ASPHALT PATHWAY
CONCRETE SIDEWALK	CONCRETE SIDEWALK
SAFETY SETBACK ZONE	SAFETY SETBACK ZONE
CAUTION SETBACK ZONE	CAUTION SETBACK ZONE
FILL CAUTION ZONE	FILL CAUTION ZONE
UNDERCUTTING OR BEDROCK HOLLOW	UNDERCUTTING OR BEDROCK HOLLOW
RECENT LOCAL LANDSLIDE ACTIVITY	RECENT LOCAL LANDSLIDE ACTIVITY

REVISIONS	
5. AS BUILT 8-22-05	
4. CHANGES PER REVIEW 5-18-05	
3. CHANGES 3-17-05	
2. RE-SUBMITTAL 2-4-05	
1. PRELIMINARY SUBMITTAL	
DWN: FEC	DATE: 10-22-04
CK'D: DLC	DATE: 2-1-05



**ROAD AND UTILITY PLANS**  
**IMPROVEMENT CONSTRUCTION**  
**PLANS FOR**  
**ANGEL HEIGHTS SUBDIVISION**  
**TO THE CITY OF STEVENSON**  
SW1/4 SECTION 36, T 3 N, R 7 E, WM  
NW1/4 SECTION 1, T 2 N, R 7 E, WM  
SKAMANIA COUNTY, WASHINGTON

Taylor Engineering, Inc.  
Civil Design and Land Planning  
228 South Columbian Avenue, Suite 104  
Goldendale, Washington 99220  
PHONE (509) 773-4945 FAX (509) 773-5088

2  
12

ROW extends 8 ft  
beyond back of  
sidewalk

ROW extends 3 ft  
beyond back of  
sidewalk

S-321



# ANGEL HEIGHTS SUBDIVISION-PHASE 1

SW1/4 OF SECTION 36, T 3 N, R 7 E, WM  
CITY OF STEVENSON, SKAMANIA CO, WA

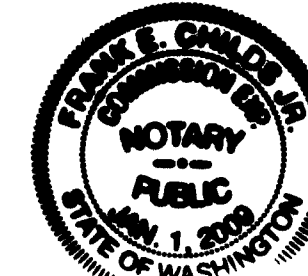

CURVE	LENGTH	RADIUS	DELTA	TANGENT
C1	78.57	50.00	90°01'45"	50.03
C2	157.67	100.00	90°20'19"	100.59
C3	81.09	100.00	46°27'32"	42.92
C4	31.43	20.00	90°01'45"	20.01
C5	110.37	70.00	90°20'19"	70.42
C6	56.76	70.00	46°27'32"	30.04
C7	36.58	130.00	16°07'20"	18.41
C8	60.73	130.00	26°45'51"	30.93
C9	52.04	50.00	59°38'02"	28.65
C10	52.36	50.00	60°00'00"	28.87
C11	46.40	50.00	53°10'17"	25.02
C12	36.16	50.00	41°26'14"	18.91
C13	37.00	50.00	42°23'49"	36.93
C14	33.36	50.00	38°13'42"	17.33
C15	59.71	50.00	68°25'40"	34.00
C16	52.24	100.00	29°56'01"	26.73
C17	29.63	100.00	16°58'41"	14.93
C18	149.51	50.00	171°19'13"	658.85
C19	36.25	130.00	15°58'37"	18.24
C20	56.59	130.00	24°56'22"	28.75
C21	109.01	130.00	48°02'44"	57.94
C22	3.12	130.00	01°22'36"	1.56
C23	8.11	130.00	03°34'21"	4.05

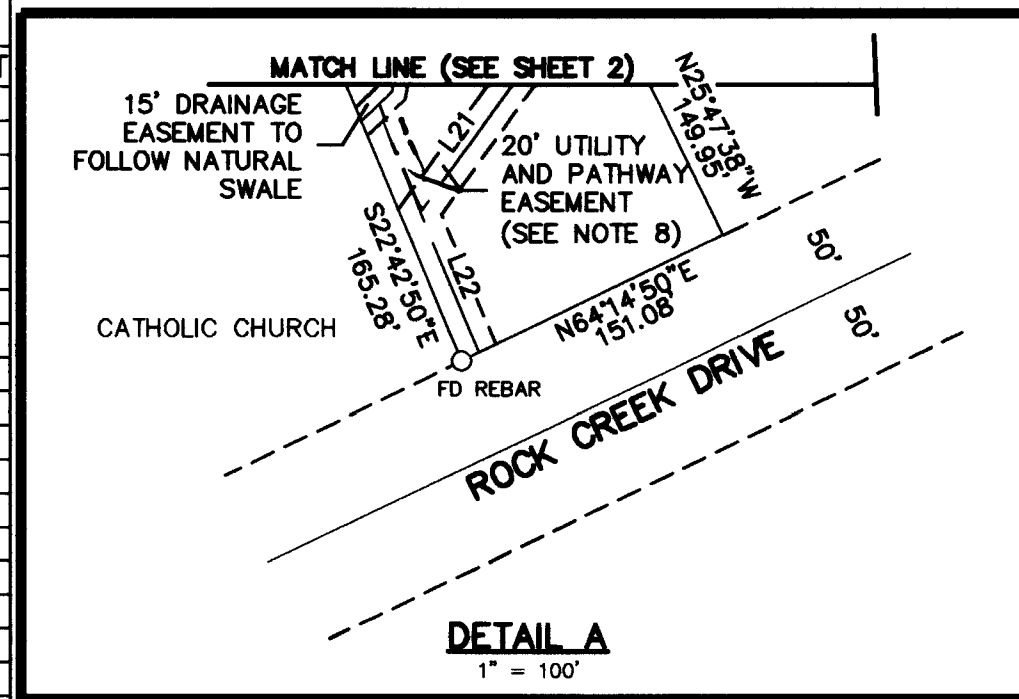

### NOTES

- CONSTRUCTION OF BUILDINGS OR SITE DISTURBING ACTIVITIES WITHIN THE SAFETY SETBACK ZONE, CAUTION SETBACK ZONE AND FILL CAUTION ZONE AS SHOWN ON LOTS B THROUGH 27 ARE SUBJECT TO CERTAIN GEOTECHNICAL REQUIREMENTS. FOR SAID REQUIREMENTS SEE THE REPORT BY BELL DESIGN COMPANY AS RECORDED IN BOOK PAGE AFN 2005158876 RECORDS OF SKAMANIA COUNTY, WASHINGTON
- ALL EASEMENTS ARE PUBLIC UNLESS OTHERWISE NOTED, EXCEPT DRAINAGE EASEMENTS WHICH ARE CITY ONLY.
- ALL EASEMENTS ARE FOR INGRESS, EGRESS AND UTILITIES.
- PHASE 1 INCLUDES THE FOLLOWING:
  - LOTS 1 THROUGH 32
  - ALL DRAINAGE EASEMENTS AND ROAD EASEMENTS IN THE FUTURE TRACT
  - THE PARK
  - THE 20' UTILITY AND PATHWAY EASEMENT THROUGH THE FUTURE TRACT, THE PARK AND THE PARCEL SOUTH OF THE PARK TO ROCK CREEK DRIVE.
- IMAN ROCK CREEK TRACTS WAS BASED ON AN OLD FENCE LINE AND ENCRACHS INTO PARCEL 1 OF THE DUDLEY SHORT PLAT. THE OLD FENCE LINE HAS BEEN HELD FOR THIS SUBDIVISION.
- ACCESS FOR LOT 30 IS VIA THE PRIVATE EASEMENT AS SHOWN ON SHEET 2.
- ACCESS TO THE DRAINAGE AND OPEN SPACE EASEMENT ON THE FUTURE TRACT IS GRANTED TO THE CITY OF STEVENSON OVER THE PRIVATE ROAD RIGHT OF WAY TO LOT 30 AND THE 30' PRIVATE EASEMENT.
- THE UTILITY AND PATHWAY EASEMENT FROM ROCK CREEK DRIVE TO THE CUL-DE-SAC IS A PUBLIC EASEMENT TO BE MAINTAINED BY THE ANGEL HEIGHTS HOME OWNERS ASSOCIATION. ANY DISTURBANCE OR DAMAGE TO THE 10' PATHWAY DONE BY THE CITY OR UTILITY COMPANIES SHALL BE REPAIRED BY SAME.
- LOT OWNERS ARE SUBJECT TO A LATECOMERS AGREEMENT FOR CONSTRUCTION OF A WATERLINE AS RECORDED UNDER NO. 2005-158705
- HOMEOWNERS ASSOCIATION SHALL BE RESPONSIBLE FOR ALL REPAIRS AND MAINTENANCE OF THE STORMWATER SYSTEM(THE SYSTEM). IF THE CITY PERFORMS ANY REPAIR OR MAINTENANCE ON THE SYSTEM, THE OWNER, ASSOCIATION, AND SUCCESSION AGREE IT SHALL BE PERMITTED TO FIX A SYSTEM MAINTENANCE CHARGE TO THE HOMEOWNERS CONTRIBUTING STORM WATER TO THE SYSTEM AS PROVIDED IN RCW 35.67.190.

### ACREAGES

PHASE 1-23.53 ACRES  
(LOTS 1-32 AND STREET)  
FUTURE TRACT-10.03 ACRES  
PARK -3.05 ACRES

### LEGEND

- SET 5/8"x24" CAPPED REBAR ●
- EXISTING REBAR-FOUND AS NOTED ○
- FD EXISTING MONUMENT ⊕
- RECORD BEARING AND DISTANCE (N89°19'21"W 2531.18')
- SAFETY SETBACK ZONE [diagonal hatching]
- CAUTION SETBACK ZONE [cross-hatching]
- FILL CAUTION ZONE [stippled]
- UNDERCUTTING OR BEDROCK HOLLOW [circle with diagonal lines]
- RECENT LOCAL LANDSLIDE ACTIVITY [horizontal hatching]
- CONSERVATION EASEMENT [diagonal hatching]

### REFERENCES

- SURVEY 137523
- SURVEY 79974
- SURVEY 104740
- SURVEY 107593
- NICKLAUS SUBDIVISION 128569
- REHAL SHORT PLAT 109019
- DUDLEY SHORT PLAT 133529
- HAZEL SHORT PLAT 137578
- IMAN ROCK CREEK TRACTS

### BASIS OF BEARINGS

SURVEY 137523

### MONUMENTS VISITED

OCTOBER, 2004

### LEGAL DESCRIPTION

**TOTAL PARCEL**  
PARCEL 1, DUDLEY SHORT PLAT NO 133529  
REMAINDER OF REHAL SHORT PLAT NO 109019  
LESS HAZEL SHORT PLAT AND LESS CATHOLIC CHURCH  
IN THE NW1/4 OF SECTION 1, T 2 N, R 7 E, WM  
AND IN THE SW1/4 OF SECTION 36, T 3 N, R 7 E, WM

LINE	LENGTH	BEARING
L1	17.98	S00°47'19"W
L2	33.62	N88°57'10"W
L3	15.74	S42°29'38"E
L4	9.60	S42°29'38"E
L5	20.47	S42°29'38"E
L6	43.55	S89°16'56"E
L7	17.00	S42°29'38"E
L8	59.21	S41°29'33"E
L9	68.28	N79°43'16"W
L10	54.45	N00°42'31"E
L11	185.96	N67°43'09"W
L12	269.29	N20°48'26"W
L13	294.16	S12°07'40"E
L14	46.50	N34°14'54"W
L15	147.48	S28°52'11"E
L16	148.87	S10°36'58"E
L17	152.66	S16°38'08"E
L18	103.38	S08°24'58"E
L19	108.02	S02°07'12"W
L20	111.85	S00°25'21"E
L21	89.49	S35°55'28"W
L22	79.28	S22°42'50"E
L23	142.45	N64°29'11"E
L25	144.09	N78°47'59"W
L26	65.95	N25°17'08"E
L27	69.01	N47°30'22"E
L28	51.45	N29°02'32"E
L29	102.61	N62°23'26"E
L30	66.77	S02°48'22"E
L31	67.63	S26°57'50"W
L32	27.88	S19°57'27"W
L33	66.11	S07°59'03"W
L34	6.00	S01°05'02"W
L35	51.10'	N01°21'35"W
L36	28.17'	S03°00'55"E
L37	73.47'	S17°02'00"E
L38	33.77'	S45°58'39"E
L39	65.17'	S38°22'32"E
L40	36.04'	S57°30'11"E
L41	40.92'	N47°25'58"W
L42	50.19'	N36°43'07"W
L43	39.21'	N30°05'18"W
L44	65.24'	N53°36'35"W
L45	59.87'	N53°36'35"W
L46	58.43'	N87°34'28"W
L47	68.09'	N18°11'14"W
L48	38.07'	N37°51'17"W
L49	87.29'	N28°42'31"W
L50	19.17'	N79°55'01"W

### DEDICATION

We, Owners of the described tract of land, hereby declare and certify this Plat to be true and correct to the best of our abilities, and that this subdivision has been made with our free consent and in accordance with our desires. Further, we hereby dedicate Angel Heights Road to the use of the public forever and waive all claims for damages against any governmental agency arising from the construction and maintenance of said road.

ANGEL HEIGHTS LLC, by BETTER WORLD ACQUISITIONS LLC  
Owner

By Mimi Morissette  
MIMI MORISSETTE  
Owner

This is to certify that on the 21st day of SEPT., 2005  
Before me personally appeared: MIMI MORISSETTE  
To me known to be the individuals described in and who executed the foregoing instrument and acknowledged to me that they signed the same as their free and voluntary act for the use and purpose set forth herein

By: July E. Cuddeh  
Notary Public in and for the State of Washington  
Residing at TROUT LAKE

Owner  
This is to certify that on the \_\_\_\_\_ day of \_\_\_\_\_, 2005  
Before me personally appeared:  
To me known to be the individuals described in and who executed the foregoing instrument and acknowledged to me that they signed the same as their free and voluntary act for the use and purpose set forth herein.

By:  
Notary Public in and for the State of Washington  
Residing at \_\_\_\_\_

I hereby certify that the city road abutting the proposed subdivision is of sufficient width to meet current city standards without requiring additional right of way and that road right of ways upon or abutting the proposed subdivision are of sufficient width to assure maintenance and to permit future utility installations. I further certify that the proposed roads meet current city standards and that city water and sewer services are available to the proposed subdivision.

Julie E. Cuddeh 9-27-05  
Public Works Director Date

I hereby certify that the taxes and assessments have been duly paid discharged or satisfied in regard to the lands involved with the above proposed subdivision thru 2005 06070633010000 03073613202000 9-28-2005  
Cherie Flood  
Skamania County Treasurer Date

Mya D. Sumer 9-28-05  
City of Stevenson Treasurer Date

This subdivision conforms with City requirements and is approved subject to the special conditions inscribed hereon and to recording in the Skamania County Auditor's office.

Julie E. Cuddeh 9-27-05  
Mayor, City of Stevenson Date

"I, Frank E. Childs, Jr., registered as a land surveyor by the State of Washington, certify that this plat is based on an actual survey of the land described herein, conducted by me or under my supervision during the period of October, 2004 through September, 2005; that the distances, courses, and angles are shown thereon correctly; and that monuments other than those approved for setting at a later date, have been set and lot corners staked on the ground as depicted on the plat.

Dated this 15th day of September, 2005

Frank E. Childs, Jr.  
Licensed Land Surveyor PLS NO.18028

STATE OF WASHINGTON)  
COUNTY OF SKAMANIA )  
I hereby certify that the within instrument of writing filed by: Better World Acquisitions at 1:00 PM on 9/28/05 2005, was recorded in Book \_\_\_\_\_ of City Plats at Page \_\_\_\_\_, AFN 2005158873

Peggy Lowry  
Recorder of Skamania County, Washington

Michael Garrison by P. Lowry  
County Auditor

**ANGEL HEIGHTS SUBDIVISION-PHASE 1**  
**TO THE CITY OF STEVENSON**  
SW1/4 SECTION 36, T 3 N, R 7 E, WM  
SKAMANIA COUNTY, WASHINGTON

**Taylor Engineering, Inc.**  
Civil Design and Land Planning  
228 South Columbus Avenue, Suite 104  
Goldendale, Washington 98620  
PHONE (509) 773-4945 FAX (509) 773-5888 JOB NO 04-G072P





*City of Stevenson*  
**Public Works Department**



PERMIT NUMBER: ROW23-01  
 Date Received: 1/5/23  
 Amount Paid: \_\_\_\_\_

**USE OF RIGHT OF WAY  
 APPLICATION**

**PERMITTEE / PROPERTY OWNER INFORMATION**

Name: Derek & Glenna Girtle      Email: derekgirtle@gmail.com

Address: City: Portland    State: Oregon    Zip: 97225  
 Phone: \_\_\_\_na

Cell Phone 503-718 1574

**CONTRACTOR INFORMATION (NA)**

CONTRACTOR: By Owner      Contact Person Email: tomo@gorge.net

DESIGN Consultant / Contact Person: Tom Owens    Contact Phone: 503-740-0840

Address: PO Box 221    City: Cascade Locks State: OR Zip: 97014

WA Contractor's Registration No : (NA)

Stevenson Business License : NO

PROJECT NAME Girtle; Retaining Wall  
 PROJECT ADDRESS 725 Angel Heights  
 (Nearest cross streets if address is not assigned)

TAX PARCEL #: O3O73633011900

**PROJECT DESCRIPTION: NATURAL STONE RETAINING WALL**

Type of Application	<input type="checkbox"/> Utility Installation	<input type="checkbox"/> Utility Connection	<input type="checkbox"/> Utility Maintenance
(Check Box)	<input checked="" type="checkbox"/> Use of right-of-way	<input type="checkbox"/> Emergency	<input type="checkbox"/> Street Closure
	<input type="checkbox"/> Landscaping	<input type="checkbox"/> Frontage Improvements	<input type="checkbox"/> Drainage Improvement
	<input type="checkbox"/> Special Event	<input type="checkbox"/> Oversize/Weight	
	Other _____		

START DATE \_\_\_\_\_ DURATION Semi - Permanent END DATE \_\_\_\_\_

CONNECT TO OTHER PERMITS \_\_\_\_\_ PERMIT TYPE: A B C D





# SETBACK EXHIBIT

## LOT 16 OF ANGEL HEIGHTS SUBDIVISION PHASE 1

### SW 1/4 OF SEC 36, T3N, R7E, W.M. CITY OF STEVENSON, SKAMANIA, WA

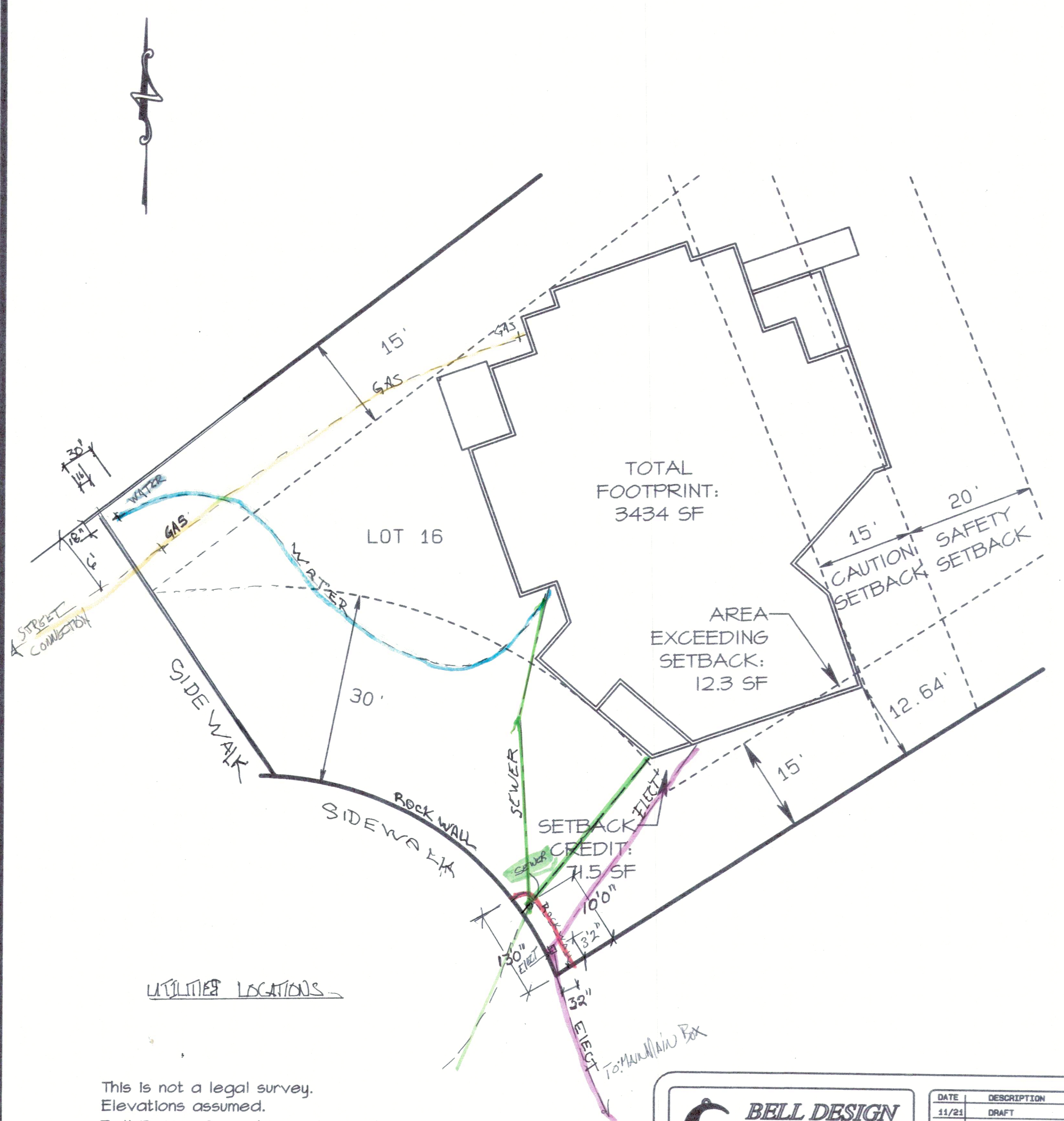

INV. # 14758

For those who needed it done - yesterday!

#### PRIVATE WORK REQUEST

Customer: Tom Owens Date: 1-18-2023  
 P.O. #: \_\_\_\_\_  
 Job #: \_\_\_\_\_  
 Billing/Email Address: \_\_\_\_\_  
 Date Requested: 1-17-2023 Requested By: Tom  
 Locate/Site Address: 725 Angel Heights Rd. Stevenson WA  
 Description of Locating Private Utilities: unknown at this time

Off. Tel.: \_\_\_\_\_ Cell #: 503-740-0840 Fax #: \_\_\_\_\_  
 Date Completed: 1-18-23 Site Contact: Call Tom w/ETA  
 Activity Summary: located to verify sanitary sewer, water, gas, & future conduit power. Verified same as updated setback exhibit. No public utilities in said walk

Please Note: This locate is being performed on private property at the customer's request. All County Locating Services, LLC has no knowledge of, and customer has not furnished as-installed plans, drawings or information of other utilities and the area of the requested locate. All County Locating Services, LLC, shall not be liable for damage to any type of utility, or any loss or injury caused by such damage.

\*Charges outstanding over 30 days from the date of service are subject to a 1 1/2% FINANCE CHARGE PER MONTH or annual percentage rate of 18%. Customer agrees to pay accrued expenses in the event of collection.

Method of Payment:  C/C  Visa  Master Card  Other \_\_\_\_\_  
 To be Billed  Cash  Check # 1085  
 Comm.  Res.  PAID IN FULL - Initials BR  
 Traffic - LT  Traffic - HWY  Wet  Dry  
 Customer Signature: [Signature]  
 Locator's Signature: [Signature]

**THIS IS YOUR INVOICE, TOTAL AMOUNT DUE ON COMPLETION OF SERVICES**

Travel 2.0 hrs. @ **\$90.00** = 180.00  
 Man Hrs 1.0 hrs. @ **\$90.00** = 90.00  
 Total = 270.00

Note: Minimum 2-hour labor charges apply. Travel is computed from our home office to the last job site. If travel is greater than one hour round trip, we will be charged.

**Thank You For Your Business!**

This is not a legal survey.  
 Elevations assumed.  
 Bell Design Co. makes no warranty as to matters of unwritten title such as adverse possession, prescriptive rights, easements, estoppel, acquiescence, etc. or to environmental concerns such as hazardous waste, pollution, wet land delineation, riparian changes, flood zones, etc.

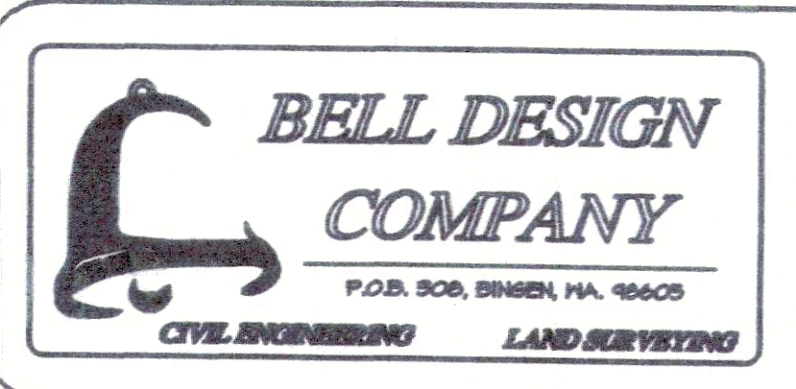

DATE	DESCRIPTION	BY
11/21	DRAFT	JMR
11/21	CHECKED	ARB

**SETBACK EXHIBIT**  
**FOR DEREK & GLENNA GIRLE**  
 STEVENSON, WASHINGTON

SHEET: 2 OF 2  
 PROJECT: 21B296  
 DATE: Nov 2021





**City of Stevenson**  
**Public Works Department**

(509)427-5970

No. 23-01 Fee. \$25

Type. A  B  C  D

7121 E Loop Road, PO Box 371  
Stevenson, Washington 98648

## RIGHT OF WAY USE PERMIT

Subject to all the terms, conditions, and provisions written or printed below or on any part of this form.  
**PERMISSION IS HEREBY GRANTED TO (Permittee) Derek and Glenna Girtle; 725 Angel Heights Rd.**

**To: Construct and maintain rock wall from back of sidewalk to edge of ROW.**

No work shall be done under this permit until the party or parties to whom it is granted shall have communicated with the City of Stevenson forty-eight (48) hours prior to start of construction.

Responsible parties shall notify the City of Stevenson twenty-four (24) hours prior to completion of work for final inspection by the Public Works Department. All work shall be in accord with standards and terms set forth in WAC 136-40 and City of Stevenson Ordinance No. 1027, summarized on the reverse side.

You are being issued a specific permit type. Review subsection 12.02.060 Right-of-way use permits of the City of Stevenson Municipal Code for more information.

**Additional Requirements: Construct concrete collar on sewer cleanout per standard detail S-3.1. Replace full sidewalk panel over wall drain per Engineering Standards. Do not impede sight distance at driveway approach. Use appropriate erosion and sediment control BMPs on disturbed soils. This permit may be revoked at any time. If required, any improvements in the ROW must be removed at City direction and at the expense of the permittee.**

The undersigned Permittee hereby accepts this permit subject to the terms and conditions as herein set forth.

I HAVE READ ORDINANCE 1027 ON THE REVERSE AND AGREE WITH ITS TERMS.

PERMITEE

\_\_\_\_\_  
Signature

\_\_\_\_\_  
Name (Printed)

\_\_\_\_\_  
City of Stevenson, Public Works Director  
Date \_\_\_\_\_

\_\_\_\_\_  
Planning Approval (if Applicable):

\_\_\_\_\_  
City of Stevenson Planning Director

**ORDINANCE NO. 1027**

**AN ORDINANCE ADDRESSING CITY OF STEVENSON, WASHINGTON REGULATIONS AND PROCEDURES FOR UTILITY INSTALLATIONS, EXCAVATIONS, REPAIRS AND OTHER USES OF CITY RIGHTS OF WAY AND REPEALING PORTIONS OF TITLE 12 STREETS, SIDEWALKS AND PUBLIC PLACES, AND PROVIDING FOR SEVERABILITY AND AN EFFECTIVE DATE.**

**WHEREAS**, the City of Stevenson is legally vested in rights of ways, and it would benefit the City to have an ordinance setting forth the laws relating to the use of the City's rights of way to protect and preserve the public health, safety and welfare and develop processes to implement these goals.

**GENERAL PROVISIONS APPLICABLE TO ALL PERMITS**

During the progress of the work such barriers shall be erected and maintained as may be necessary or as may be directed for the protection of the traveling public: the barriers shall be properly lighted at night.

In accepting this permit the petitioner, his successors and assigns, agrees to protect the City of Stevenson and save it harmless from all claims, actions or damages of every kind and description which may accrue to or be suffered by any person or persons, corporation or property by reason of the performance of any such work, character of materials used or manner of installation, maintenance and operation or by the improper occupancy of rights of way or public place or public structure, and in case any suit or action is brought against said City of Stevenson for damages arising out of or by reason of any of the above causes, the petitioner, his successors or assigns will upon notice to him or them of commencement of such action, defend the same at his or their own sole cost and expense and will satisfy any judgement after the said suit or action shall have finally been determined if adverse to the City of Stevenson.

Except as herein authorized, no excavation shall be made or obstacle placed within the limits of a City street in such a manner as to interfere with the travel over said road.

If the work done under this permit interferes in any way with the drainage of the city streets, the grantee shall wholly and at his own expense make such provision as the Director may direct to take care of said drainage.

On completion of said work herein contemplated all rubbish and debris shall be immediately removed and the roadway and roadside shall be left neat and presentable and satisfactory to the Director.

All of the work herein contemplated shall be done under the supervision of and to the satisfaction of the Director and the entire expense of said supervision shall be borne by the party or parties to whom this permit is issued.

This permit or privilege shall not be deemed or held to be an exclusive one and shall not prohibit the City from granting other permits of like or other nature to other public or private utilities, nor shall it prevent the City from using any of its roads, streets, or public places, or affect its right to full supervision and control over all or any part of them, none of which is hereby surrendered.

The Director may revoke, annul, change, amend, amplify, or terminate this permit or any of the conditions herein enumerated if grantee fails to comply with any or all of its provisions, requirements or regulations as herein set forth or thru willful or unreasonable neglect, fails to heed or comply with notice given or if the utility herein granted is not installed or operated and maintained in conformity herewith or at all or for any cause or reason whatsoever.

The party or parties to whom this permit is issued shall maintain at his or their sole expense the structure or object for which this permit is granted to a condition satisfactory to the City's Director.

In accepting this permit the grantee, his successors and assigns, agree that any damage or injury done to the property of the grantee or any expense incurred by him through the operation of a contractor, working for the City or of any City employee shall be the sole expense of the grantee, his successors or assigns.



**Grant to**

City of Stevenson

through

The Local and Community Projects Program

**For**

Skamania Courthouse Plaza

**Start date:** July 1, 2019



Table of Contents

FACE SHEET ..... 1

DECLARATIONS ..... 2

ADDITIONAL RECITALS ..... 2

SPECIAL TERMS AND CONDITIONS ..... 3

    1. GRANT MANAGEMENT ..... 3

    2. COMPENSATION ..... 3

    3. CERTIFICATION OF FUNDS PERFORMANCE MEASURES..... 3

    4. PREVAILING WAGE LAW ..... 4

    5. DOCUMENTATION AND SECURITY ..... 4

    6. BASIS FOR ESTABLISHING REAL PROPERTY VALUES FOR ACQUISITIONS OF REAL  
PROPERTY PERFORMANCE MEASURES..... 4

    7. EXPENDITURES ELIGIBLE FOR REIMBURSEMENT ..... 5

    8. BILLING PROCEDURES AND PAYMENT ..... 5

    9. SUBCONTRACTOR DATA COLLECTION..... 6

    10. CERTIFIED PROJECT COMPLETION REPORT AND FINAL PAYMENT ..... 6

    11. INSURANCE ..... 6

    12. ORDER OF PRECEDENCE ..... 8

    13. REDUCTION IN FUNDS..... 8

    14. OWNERSHIP OF PROJECT/CAPITAL FACILITIES..... 9

    15. CHANGE OF OWNERSHIP OR USE FOR GRANTEE-OWNED PROPERTY ..... 9

    16. CHANGE OF USE FOR LEASED PROPERTY PERFORMANCE MEASURE ..... 9

    17. SIGNAGE, MARKERS AND PUBLICATIONS..... 9

    18. HISTORICAL AND CULTURAL ARTIFACTS..... 9

    19. REAPPROPRIATION..... 10

    20. TERMINATION FOR FRAUD OR MISREPRESENTATION ..... 10

    21. APPLICABILITY OF COPYRIGHT PROVISIONS TO ARCHITECTURAL/ENGINEERING DESIGN  
WORK..... 11

    22. FRAUD AND OTHER LOSS REPORTING ..... 11

    23. PUBLIC RECORDS ACT ..... 11

GENERAL TERMS AND CONDITIONS ..... 12

    24. DEFINITIONS..... 12

    25. ACCESS TO DATA..... 12

    26. ADVANCE PAYMENTS PROHIBITED..... 12

    27. ALL WRITINGS CONTAINED HEREIN..... 12

    28. AMENDMENTS..... 12

    29. AMERICANS WITH DISABILITIES ACT (ADA) OF 1990, PUBLIC LAW 101-336, ALSO  
REFERRED TO AS THE “ADA” 28 CFR PART 35..... 13

    30. ASSIGNMENT..... 13

    31. ATTORNEYS’ FEES ..... 13

    32. AUDIT..... 13



33. BREACHES OF OTHER STATE CONTRACTS.....	14
34. CONFIDENTIALITY/SAFEGUARDING OF INFORMATION.....	14
35. CONFLICT OF INTEREST .....	14
36. COPYRIGHT PROVISIONS .....	15
37. DISPUTES .....	15
38. DUPLICATE PAYMENT.....	16
39. GOVERNING LAW AND VENUE .....	16
40. INDEMNIFICATION .....	16
41. INDEPENDENT CAPACITY OF THE GRANTEE.....	16
42. INDUSTRIAL INSURANCE COVERAGE .....	17
43. LAWS .....	17
44. LICENSING, ACCREDITATION AND REGISTRATION.....	17
45. LIMITATION OF AUTHORITY .....	17
46. NONCOMPLIANCE WITH NONDISCRIMINATION LAWS.....	17
47. PAY EQUITY.....	17
48. POLITICAL ACTIVITIES .....	18
49. PUBLICITY.....	18
50. RECAPTURE .....	18
51. RECORDS MAINTENANCE .....	18
52. REGISTRATION WITH DEPARTMENT OF REVENUE.....	18
53. RIGHT OF INSPECTION .....	18
54. SAVINGS .....	18
55. SEVERABILITY.....	19
56. SITE SECURITY .....	19
57. SUBGRANTING/SUBCONTRACTING.....	19
58. SURVIVAL.....	19
59. TAXES.....	19
60. TERMINATION FOR CAUSE .....	19
61. TERMINATION FOR CONVENIENCE .....	20
62. TERMINATION PROCEDURES .....	20
63. TREATMENT OF ASSETS.....	21
64. WAIVER .....	21
ATTACHMENT A - SCOPE OF WORK.....	22
ATTACHMENT B - CERTIFICATION OF THE AVAILABILITY OF FUNDS TO COMPLETE THE PROJECT.....	24
ATTACHMENT C- CERTIFICATION OF THE PAYMENT AND REPORTING OF PREVAILING WAGES .....	26
ATTACHMENT D - CERTIFICATION OF INTENT TO ENTER THE LEADERSHIP IN ENERGY AND ENVIRONMENTAL DESIGN (LEED) CERTIFICATION PROCESS.....	28

**FACE SHEET**

Grant Number: **20-96627-230**  
Project Name: **Skamania Courthouse Plaza**

**Washington State Department of Commerce  
Local Government Division  
Community Development Assistance Unit**

<b>1. GRANTEE</b> City of Stevenson PO Box 371 Stevenson, WA 98639-0371		<b>2. GRANTEE Doing Business As (optional)</b> N/A	
<b>3. GRANTEE Representative</b> Leana Kinley, City Administrator (509) 427-5970 x 204 leana@ci.stevenson.wa.us		<b>4. COMMERCE Representative</b> Mara Isaacson, Grant Manager PO Box 42525, Olympia, WA 98504 (360) 742-7665 mara.isaacson@commerce.wa.gov	
<b>5. Grant Amount</b> \$147,000.00	<b>6. Funding Source</b> Federal: State: X Other: N/A:	<b>7. Start Date</b> July 1, 2019	<b>8. End Date</b> June 30, 2025, contingent on reappropriation; June 30, 2023 if funds are not reappropriated.
<b>9. Federal Funds (as applicable)</b> N/A		<b>Federal Agency</b> N/A	<b>CFDA Number</b> N/A
<b>10. Tax ID #</b> N/A	<b>11. SWV #</b> SWV0019082-00	<b>12. UBI #</b> 301000029	<b>13. DUNS #</b> 025644105
<b>14. Grant Purpose</b> The purpose of this performance-based Grant Agreement is to provide funding for a legislatively approved project that furthers the goals and objectives of the Local and Community Projects Program as described in Attachment A – Scope of Work (the “Project”).			
COMMERCE, defined as the Washington State Department of Commerce, and the GRANTEE, as defined above, acknowledge and accept the terms of this Grant and attachments and have executed this Grant on the date below to start as of the date and year referenced above. The rights and obligations of both parties to this Grant are governed by this Grant and the following other documents incorporated by reference: Grant Terms and Conditions including Attachment “A” – Scope of Work, Attachment “B” – Certification of Availability of Funds to Complete the Project, Attachment “C” – Certification of the Payment and Reporting of Prevailing Wages, Attachment “D” – Certification of Intent to Enter LEED Process.			
<b>FOR GRANTEE</b>  _____ Signature  _____ Print Name  _____ Title  _____ Date		<b>FOR COMMERCE</b>  _____ Mark K. Barkley, Assistant Director Local Government Division  _____ Date  <b>APPROVED AS TO FORM</b>  _____ Steve Scheele, Assistant Attorney General  _____ 2/7/2023 Date	

## DECLARATIONS

### GRANTEE INFORMATION

GRANTEE Name: **City of Stevenson**  
Grant Number: 20-96627-230  
State Wide Vendor Number: SWV0019082-00

### PROJECT INFORMATION

Project Name: **Skamania Courthouse Plaza**  
Project City: Stevenson  
Project State: Washington  
Project Zip Code: 98639-0371

### GRANT AGREEMENT INFORMATION

Grant Amount: **\$147,000.00**  
Appropriation Number: SHB 1102 SL Section 1042 (2019 Regular Session)  
Re-appropriation Number (if applicable): SHB 1080 SL Section 1041 (2021 Regular Session)  
Grant End Date: **June 30, 2025, contingent on reappropriation;**  
June 30, 2023, if funds are not reappropriated.  
Biennium: 2021-2023  
Biennium Close Date: June 30, 2023

### PROJECT PURPOSE

Complete plans to be shovel-ready for the Skamania County Courthouse Park Plaza project.

### ADDITIONAL SPECIAL TERMS AND CONDITIONS GOVERNING THIS AGREEMENT

**Grant End Date:** In the event funds for the project are reappropriated, the contract end date will be extended pursuant to the reappropriation and consistent with Special Term and Condition 19. Depending on the reappropriation, a contract amendment may be required.

### ADDITIONAL RECITALS

N/A

**SPECIAL TERMS AND CONDITIONS**  
**GENERAL GRANT**  
**STATE FUNDS**

THIS GRANT AGREEMENT, entered into by and between the GRANTEE and COMMERCE, as defined on the Face Sheet of this Grant Agreement, WITNESSES THAT:

WHEREAS, COMMERCE has the statutory authority under RCW 43.330.050 (5) to cooperate with and provide assistance to local governments, businesses, and community-based organizations; and

WHEREAS, COMMERCE is also given the responsibility to administer state funds and programs which are assigned to COMMERCE by the Governor or the Washington State Legislature; and

WHEREAS, the Washington State Legislature has made an appropriation to support the Local and Community Projects Program, and directed COMMERCE to administer those funds; and

WHEREAS, the enabling legislation also stipulates that the GRANTEE is eligible to receive funding for design, acquisition, construction, or rehabilitation.

NOW, THEREFORE, in consideration of covenants, conditions, performances, and promises hereinafter contained, the parties hereto agree as follows:

**1. GRANT MANAGEMENT**

The Representative for each of the parties shall be responsible for and shall be the contact person for all communications and billings regarding the performance of this Grant.

The Representative for COMMERCE and their contact information are identified on the Face Sheet of this Grant.

The Representative for the GRANTEE and their contact information are identified on the Face Sheet of this Grant.

**2. COMPENSATION**

COMMERCE shall pay an amount not to exceed the awarded Grant Amount as shown on the Face Sheet of this Grant Agreement, for the capital costs necessary for or incidental to the performance of work as set forth in the Scope of Work.

**3. CERTIFICATION OF FUNDS PERFORMANCE MEASURES**

A. The release of state funds under this Grant Agreement is contingent upon the GRANTEE certifying that it has expended or has access to funds from non-state sources as set forth in ATTACHMENT B (CERTIFICATION OF THE AVAILABILITY OF FUNDS TO COMPLETE THE PROJECT), hereof. Such non-state sources may consist of a combination of any of the following:

- i) Eligible Project expenditures prior to the execution of this Grant Agreement.
- ii) Cash dedicated to the Project.
- iii) Funds available through a letter of credit or other binding loan commitment(s).
- iv) Pledges from foundations or corporations.
- v) Pledges from individual donors.
- vi) The value of real property when acquired solely for the purposes of this Project, as established and evidenced by a current market value appraisal performed by a licensed, professional real estate appraiser, or a current property tax statement. COMMERCE will not consider appraisals for prospective values of such property for the purposes of calculating the amount of non-state matching fund credit.
- vii) In-kind contributions, subject to COMMERCE'S approval.

- B. The GRANTEE shall maintain records sufficient to evidence that it has access to or has expended funds from such non-state sources, and shall make such records available for COMMERCE's review upon reasonable request.

**4. PREVAILING WAGE LAW**

The Project funded under this Grant may be subject to state prevailing wage law (Chapter 39.12 RCW). The GRANTEE is advised to consult the Industrial Statistician at the Washington Department of Labor and Industries to determine whether prevailing wages must be paid. COMMERCE is not responsible for determining whether prevailing wage applies to this Project or for any prevailing wage payments that may be required by law.

**5. DOCUMENTATION AND SECURITY**

The provisions of this section shall apply to capital projects performed by nonprofit organizations and public benefit corporations that involve the expenditure of over \$500,000 in state funds. Additionally, Commerce reserves the right to review all state-funded projects and to require that projects performed by other entity types comply with this section. Projects for which the grant award or legislative intent documents specify that the state funding is to be used for design only are exempt from this section.

- A. Deed of Trust. This Grant shall be evidenced by a promissory note and secured by a deed of trust or other appropriate security instrument in favor of COMMERCE (the "Deed of Trust"). The Deed of Trust shall be recorded in the County where the Project is located, and the original returned to COMMERCE after recordation within ninety (90) days of Grant Agreement execution. The Deed of Trust must be recorded before COMMERCE will reimburse the GRANTEE for any Project costs. The amount secured by the Deed of Trust shall be the amount of the Grant as set forth on the Face Sheet, hereof.
- B. Term of Deed of Trust. The Deed of Trust shall remain in full force and effect for a minimum period of ten (10) years following the later of: (1) final payment of state funds to the GRANTEE under this grant; or (2) the date when the facility improved or acquired with grant funds, or a distinct phase of the project, is made useable to the public for the purpose intended by the Legislature. Upon satisfaction of the ten-year term requirement and all other grant terms and conditions, COMMERCE shall, upon written request of the GRANTEE, take appropriate action to reconvey the Deed of Trust.
- C. Title Insurance. The GRANTEE shall purchase an extended coverage lender's policy of title insurance insuring the lien position of the Deed of Trust in an amount not less than the amount of the grant.
- D. Covenant. If the project will be partially funded by a loan and the term of said loan is less than the commitment period under this grant contract, COMMERCE may require that GRANTEE record or cause to be recorded a covenant in a superior lien position ahead of the lender's security instrument that restricts use of the facility or property for the purpose(s) stated elsewhere in this contract for at least the term of the commitment period
- E. Subordination. COMMERCE may agree to subordinate its deed of trust upon request from a private or public lender. Any such request shall be submitted to COMMERCE in writing, and COMMERCE shall respond to the request in writing within thirty (30) days of receiving the request.

**6. BASIS FOR ESTABLISHING REAL PROPERTY VALUES FOR ACQUISITIONS OF REAL PROPERTY PERFORMANCE MEASURES**

When all or part of the grant is used to fund the acquisition of real property, before funds are disbursed, the GRANTEE shall procure and provide to COMMERCE evidence establishing the value of the real property eligible for reimbursement:

- A. GRANTEE purchases of real property from an independent third-party seller shall be evidenced by a current appraisal prepared by a licensed Washington State commercial real estate appraiser, or a current property tax statement.
- B. GRANTEE purchases of real property from a subsidiary organization, such as an affiliated LLC, shall be evidenced by a current appraisal prepared by a licensed Washington State

commercial real estate appraiser or the prior purchase price of the property plus holding costs, whichever is less.

**7. EXPENDITURES ELIGIBLE FOR REIMBURSEMENT**

Payments to the Grantee shall be made on a reimbursement basis only. The GRANTEE may be reimbursed for the following eligible costs related to the activities identified in the SCOPE OF WORK shown on Attachment A.

- A. Real property, and costs directly associated with such purchase, when purchased or acquired solely for the purposes of the Project;
- B. Design, engineering, architectural, and planning;
- C. Construction management and observation (from external sources only);
- D. Construction costs including, but not limited to, the following:
  - Site preparation and improvements;
  - Permits and fees;
  - Labor and materials;
  - Taxes on Project goods and services;
  - Capitalized equipment;
  - Information technology infrastructure; and
  - Landscaping.
- F. Other costs authorized through the legislation.

**8. BILLING PROCEDURES AND PAYMENT**

COMMERCE shall reimburse the GRANTEE for eligible Project expenditures, up to the maximum payable under this Grant Agreement. When requesting reimbursement for expenditures made, the GRANTEE shall submit to COMMERCE a signed and completed Invoice Voucher (Form A-19), that documents capitalized Project activity performed for the billing period. The GRANTEE can submit all Invoice Vouchers and any required documentation electronically through COMMERCE's Contracts Management System (CMS), which is available through the Secure Access Washington (SAW) portal.

The GRANTEE shall evidence the costs claimed on each voucher by including copies of each invoice received from vendors providing Project goods or services covered by the Grant Agreement. The GRANTEE shall also provide COMMERCE with a copy of the cancelled check or electronic funds transfer, as applicable, that confirms that they have paid each expenditure being claimed. The cancelled checks or electronic funds transfers may be submitted to COMMERCE at the time the voucher is initially submitted, or within thirty (30) days thereafter.

The voucher must be certified (signed) by an official of the GRANTEE with authority to bind the GRANTEE. The final voucher shall be submitted to COMMERCE within sixty (60) days following the completion of work or other termination of this Grant Agreement, or within fifteen (15) days following the end of the state biennium unless Grant Agreement funds are reappropriated by the Legislature in accordance with Section 19, hereof.

If GRANTEE has or will be submitting any of the invoices attached to a request for payment for partial reimbursement under another grant contract, GRANTEE must clearly identify such grant contracts in the transmittal letter and request for payment.

Each request for payment must be accompanied by a Project Status Report, which describes, in narrative form, the progress made on the Project since the last invoice was submitted, as well as a report of Project status to date. COMMERCE will not release payment for any reimbursement request received unless and until the Project Status Report is received. After approving the Invoice Voucher and Project Status Report, COMMERCE shall promptly remit a warrant to the GRANTEE.

COMMERCE will pay GRANTEE upon acceptance of services provided and receipt of properly completed invoices, which shall be submitted to the Representative for COMMERCE **not more often than monthly**.

Payment shall be considered timely if made by COMMERCE within thirty (30) calendar days after receipt of properly completed invoices. Payment shall be sent to the address designated by the GRANTEE.

COMMERCE may, in its sole discretion, terminate the Grant or withhold payments claimed by the GRANTEE for services rendered if the GRANTEE fails to satisfactorily comply with any term or condition of this Grant.

No payments in advance or in anticipation of services or supplies to be provided under this Agreement shall be made by COMMERCE.

Duplication of Billed Costs

The GRANTEE shall not bill COMMERCE for services performed under this Grant Agreement, and COMMERCE shall not pay the GRANTEE, if the GRANTEE is entitled to payment or has been or will be paid by any other source, including grants, for that service.

Disallowed Costs

The GRANTEE is responsible for any audit exceptions or disallowed costs incurred by its own organization or that of its subgrantees.

**9. SUBCONTRACTOR DATA COLLECTION**

GRANTEE will submit reports, in a form and format to be provided by COMMERCE and at intervals as agreed by the parties, regarding work under this Grant performed by subcontractors and the portion of Grant funds expended for work performed by subcontractors, including but not necessarily limited to minority-owned, woman-owned, and veteran-owned business subcontractors. "Subcontractors" shall mean subcontractors of any tier.

**10. CERTIFIED PROJECT COMPLETION REPORT AND FINAL PAYMENT**

The GRANTEE shall complete a Certified Project Completion Report when activities identified in the SCOPE OF WORK shown on Attachment A are complete.

The GRANTEE shall provide the following information to COMMERCE:

- A. A certified statement that the Project, as described in the SCOPE OF WORK shown on Attachment A, is complete and, if applicable, meets required standards.
- B. A certified statement of the actual dollar amounts spent, from all funding sources, in completing the project as described in the SCOPE OF WORK shown on Attachment A.
- C. Certification that all costs associated with the Project have been incurred and accounted for. Costs are incurred when goods and services are received and/or Grant work is performed.
- D. A final voucher for the remaining eligible funds, including any required documentation.

The GRANTEE will submit the Certified Project Completion Report together with the last Invoice Voucher for a sum not to exceed the balance of the Grant Amount.

**11. INSURANCE**

A. Insurance Requirements for Reimbursable Activities

The GRANTEE will maintain appropriate insurance coverage throughout any period in which reimbursable activities are conducted. The intent of the required insurance is to protect the state of Washington should there be any claims, suits, actions, costs, damages or expenses arising from any loss, or negligent or intentional act or omission of the GRANTEE, or Subgrantee, or agents of either, while performing under the terms of this Grant.

B. Additional Insurance Requirements During the Term of the Grant

The GRANTEE shall provide proof to COMMERCE of the following insurance coverage as applicable:

**Commercial General Liability Insurance Policy.** Provide a Commercial General Liability Insurance Policy, including contractual liability, written on an occurrence basis, in adequate quantity to protect against legal liability related to this Grant but no less than \$1,000,000 per occurrence. Additionally, the GRANTEE is responsible for ensuring that any Subgrantee/subcontractor provide adequate insurance coverage for the activities arising out of subgrants/subcontracts. Commercial General Liability Insurance coverage shall be maintained in full force and effect during the term of this Grant and throughout the commitment period described in Special Terms and Conditions Section 5, 15, and 16.

**Property Insurance.** The GRANTEE shall keep the property insured in an amount sufficient to permit such insurance to be written at all times on a replacement cost basis. Such insurance shall cover the following hazards, as applicable:

- Loss or damage by fire and such other risks;
- Loss or damage from leakage or sprinkler systems now or hereafter installed in any building on the premises;
- Loss or damage by explosion of steam boilers, pressure vessels, oil or gasoline storage tanks or similar apparatus now or hereafter installed in a building or building on the premises.

Property Insurance coverage shall be maintained in full force and effect during the term of this Grant and throughout the commitment period described in Special Terms and Conditions Section 5, 15, and 16.

**Professional Liability, Errors and Omissions Insurance.** If GRANTEE will be providing any professional services to be reimbursed under this Grant, the GRANTEE shall maintain Professional Liability or Errors and Omissions Insurance with minimum limits of no less than \$1,000,000 per occurrence to cover all activities by the GRANTEE and licensed staff employed or under contract to the GRANTEE. The state of Washington, its agents, officers, and employees need *not* be named as additional insureds under this policy.

**Fidelity Insurance.** Every officer, director, employee, or agent who is authorized to act on behalf of the GRANTEE for the purpose of receiving or depositing funds into program accounts or issuing financial documents, checks, or other instruments of payment for program costs shall be insured to provide protection against loss:

- A. The amount of fidelity coverage secured pursuant to this Grant shall be \$2,000,000 or the highest of planned reimbursement for the Grant period, whichever is lowest. Fidelity insurance secured pursuant to this paragraph shall name COMMERCE as beneficiary.
- B. Subgrantees/subcontractors that receive \$10,000 or more per year in funding through this Grant shall secure fidelity insurance as noted above. Fidelity insurance secured by Subgrantees/subcontractors pursuant to this paragraph shall name the GRANTEE and the GRANTEE's fiscal agent as beneficiary.
- C. Fidelity Insurance coverage shall be maintained in full force and effect during the term of this Grant.

The insurance required shall be issued by an insurance company authorized to do business within the state of Washington. The insurance shall name the state of Washington, its agents, officers, and employees as additional insureds under the insurance policy. All policies shall be primary to any other valid and collectable insurance. The GRANTEE shall instruct the insurers to give COMMERCE thirty (30) calendar days advance notice of any insurance cancellation or modification.



The GRANTEE shall provide to COMMERCE copies of insurance instruments or certifications from the insurance issuing agency. The copies or certifications shall show the insurance coverage, the designated beneficiary, who is covered, the amounts, the period of coverage, and that COMMERCE will be provided thirty (30) days advance written notice of cancellation.

During the term of the Grant, the GRANTEE shall submit renewal certificates not less than thirty (30) calendar days prior to expiration of each policy required under this section.

**Professional Liability, Errors and Omissions Insurance.** The GRANTEE shall require that any contractors providing professional services that are reimbursable under this Grant maintain Professional Liability or Errors and Omissions Insurance. The GRANTEE shall require such contractors to maintain minimum limits of no less than \$1,000,000 per occurrence. The state of Washington, its agents, officers, and employees need *not* be named as additional insureds under these policies.

**GRANTEES and Local Governments that Participate in a Self-Insurance Program.**

Self-Insured/Liability Pool or Self-Insured Risk Management Program – With prior approval from COMMERCE, the GRANTEE may provide the coverage above under a self-insured/liability pool or self-insured risk management program. In order to obtain permission from COMMERCE, the GRANTEE shall provide: (1) a description of its self-insurance program, and (2) a certificate and/or letter of coverage that outlines coverage limits and deductibles. All self-insured risk management programs or self-insured/liability pool financial reports must comply with Generally Accepted Accounting Principles (GAAP) and adhere to accounting standards promulgated by: 1) Governmental Accounting Standards Board (GASB), 2) Financial Accounting Standards Board (FASB), and 3) the Washington State Auditor's annual instructions for financial reporting. GRANTEE's participating in joint risk pools shall maintain sufficient documentation to support the aggregate claim liability information reported on the balance sheet. The state of Washington, its agents, and employees need not be named as additional insured under a self-insured property/liability pool, if the pool is prohibited from naming third parties as additional insured.

GRANTEE shall provide annually to COMMERCE a summary of coverages and a letter of self insurance, evidencing continued coverage under GRANTEE's self-insured/liability pool or self-insured risk management program. Such annual summary of coverage and letter of self insurance will be provided on the anniversary of the start date of this Agreement.

**12. ORDER OF PRECEDENCE**

In the event of an inconsistency in this Grant, the inconsistency shall be resolved by giving precedence in the following order:

- Applicable federal and state of Washington statutes and regulations
- Declarations page of this Grant Agreement
- Special Terms and Conditions
- General Terms and Conditions
- Attachment A – Scope of Work
- Attachment B – Certification of the Availability of Funds to Complete the Project
- Attachment C – Certification of the Payment and Reporting of Prevailing Wages
- Attachment D – Certification of Intent to Enter the Leadership in Energy and Environmental Design (LEED) Certification Process

**13. REDUCTION IN FUNDS**

In the event state funds appropriated for the work contemplated under this Grant Agreement are withdrawn, reduced, or limited in any way by the Governor or the Washington State Legislature during the Grant Agreement period, the parties hereto shall be bound by any such revised funding limitations as implemented at the discretion of COMMERCE, and shall meet and renegotiate the Grant Agreement accordingly.

**14. OWNERSHIP OF PROJECT/CAPITAL FACILITIES**

COMMERCE makes no claim to any real property improved or constructed with funds awarded under this Grant Agreement and does not assert and will not acquire any ownership interest in or title to the capital facilities and/or equipment constructed or purchased with state funds under this Grant Agreement; provided, however, that COMMERCE may be granted a security interest in real property, to secure funds awarded under this Grant Agreement. This provision does not extend to claims that COMMERCE may bring against the GRANTEE in recapturing funds expended in violation of this Grant Agreement.

**15. CHANGE OF OWNERSHIP OR USE FOR GRANTEE-OWNED PROPERTY**

- A. The GRANTEE understands and agrees that any and all real property or facilities owned by the GRANTEE that are acquired, constructed, or otherwise improved by the GRANTEE using state funds under this Grant Agreement, shall be held and used by the GRANTEE for the purpose or purposes stated elsewhere in this Grant Agreement for a period of at least ten (10) years from the later of: (1) the date the final payment is made hereunder; or (2) the date when the facility improved or acquired with grant funds, or a distinct phase of the project, is made useable to the public for the purpose intended by the Legislature.
- B. This provision shall not be construed to prohibit the GRANTEE from selling any property or properties described in this section; Provided, that any such sale shall be subject to prior review and approval by COMMERCE, and that all proceeds from such sale shall be applied to the purchase price of a different facility or facilities of equal or greater value than the original facility and that any such new facility or facilities will be used for the purpose or purposes stated elsewhere in this Grant Agreement.
- C. In the event the GRANTEE is found to be out of compliance with this section, the GRANTEE shall repay to the state general fund the principal amount of the grant as stated on the Face Sheet, hereof, plus interest calculated at the rate of interest on state of Washington general obligation bonds issued most closely to the effective date of the legislation in which the subject facility was authorized. Repayment shall be made pursuant to Section 50 (Recapture provision).

**16. CHANGE OF USE FOR LEASED PROPERTY PERFORMANCE MEASURE**

- A. The GRANTEE understands and agrees that any facility leased by the GRANTEE that is constructed, renovated, or otherwise improved using state funds under this Grant Agreement shall be used by the GRANTEE for the purpose or purposes stated elsewhere in this Grant Agreement for a period of at least ten (10) years from the later of: (1) the date the final payment is made hereunder; or (2) the date when the facility improved or acquired with grant funds, or a distinct phase of the project, is made useable to the public for the purpose intended by the Legislature.
- B. In the event the GRANTEE is found to be out of compliance with this section, the GRANTEE shall repay to the state general fund the principal amount of the grant as stated on the Face Sheet, hereof, plus interest calculated at the rate of interest on state of Washington general obligation bonds issued most closely to the effective date of the legislation in which the subject facility was authorized. Repayment shall be made pursuant to Section 50 (Recapture Provision).

**17. SIGNAGE, MARKERS AND PUBLICATIONS**

If, during the period covered by this Grant Agreement, the GRANTEE displays or circulates any communication, publication, or donor recognition identifying the financial participants in the Project, any such communication or publication must identify "The Taxpayers of Washington State" as a participant.

**18. HISTORICAL AND CULTURAL ARTIFACTS**

Prior to approval and disbursement of any funds awarded under this Contract, GRANTEE shall cooperate with COMMERCE to complete the requirements of Governor's Executive Order 21-02 or GRANTEE shall complete a review under Section 106 of the National Historic Preservation Act, if applicable. GRANTEE agrees that the GRANTEE is legally and financially responsible for compliance

with all laws, regulations, and agreements related to the preservation of historical or cultural resources and agrees to hold harmless COMMERCE and the state of Washington in relation to any claim related to such historical or cultural resources discovered, disturbed, or damaged as a result of the project funded by this Contract.

In addition to the requirements set forth in this Contract, GRANTEE shall, in accordance with Governor's Executive Order 21-02 as applicable, coordinate with Commerce and the Washington State Department of Archaeology and Historic Preservation ("DAHP"), including any recommended consultation with any affected tribe(s), during Project design and prior to construction to determine the existence of any tribal cultural resources affected by Project. GRANTEE agrees to avoid, minimize, or mitigate impacts to the cultural resource as a continuing prerequisite to receipt of funds under this Contract.

The GRANTEE agrees that, unless the GRANTEE is proceeding under an approved historical and cultural monitoring plan or other memorandum of agreement, if historical or cultural artifacts are discovered during construction, the GRANTEE shall immediately stop construction and notify the local historical preservation officer and the state's historical preservation officer at DAHP, and the Commerce Representative identified on the Face Sheet. If human remains are uncovered, the GRANTEE shall report the presence and location of the remains to the coroner and local enforcement immediately, then contact DAHP and the concerned tribe's cultural staff or committee.

The GRANTEE shall require this provision to be contained in all subcontracts for work or services related to the Scope of Work attached hereto.

In addition to the requirements set forth in this Contract, GRANTEE agrees to comply with RCW 27.44 regarding Indian Graves and Records; RCW 27.53 regarding Archaeological Sites and Resources; RCW 68.60 regarding Abandoned and Historic Cemeteries and Historic Graves; and WAC 25-48 regarding Archaeological Excavation and Removal Permits.

Completion of the requirements of Section 106 of the National Historic Preservation Act shall substitute for completion of Governor's Executive Order 21-02.

In the event that the GRANTEE finds it necessary to amend the Scope of Work the GRANTEE may be required to re-comply with Governor's Executive Order 21-02, or Section 106 of the National Historic Preservation Act.

## **19. REAPPROPRIATION**

- A. The parties hereto understand and agree that any state funds not expended by the BIENNIUM CLOSE DATE listed on the Declarations page will lapse on that date unless specifically reappropriated by the Washington State Legislature. If funds are so reappropriated, the state's obligation under the terms of this Grant Agreement shall be contingent upon the terms of such reappropriation.
- B. In the event any funds awarded under this Grant Agreement are reappropriated for use in a future biennium, COMMERCE reserves the right to assign a reasonable share of any such reappropriation for administrative costs.

## **20. TERMINATION FOR FRAUD OR MISREPRESENTATION**

In the event the GRANTEE commits fraud or makes any misrepresentation in connection with the Grant application or during the performance of this Grant Agreement, COMMERCE reserves the right to terminate or amend this Grant Agreement accordingly, including the right to recapture all funds disbursed to the GRANTEE under the Grant.

**21. APPLICABILITY OF COPYRIGHT PROVISIONS TO ARCHITECTURAL/ENGINEERING DESIGN WORK**

The "Copyright Provisions", Section 36 of the General Terms and Conditions, are not intended to apply to any architectural and engineering design work funded by this grant.

**22. FRAUD AND OTHER LOSS REPORTING**

Contractor/Grantee shall report in writing all known or suspected fraud or other loss of any funds or other property furnished under this Contract immediately or as soon as practicable to the Commerce Representative identified on the Face Sheet.

**23. PUBLIC RECORDS ACT**

Notwithstanding General Terms and Conditions Section 34, COMMERCE is a public agency subject to the Public Records Act, Chapter 42.56 RCW (the "PRA"). Under the PRA, all materials relating to the conduct of government or the performance of any governmental or proprietary function prepared, owned, used, or retained by COMMERCE or its functional equivalents are considered public records. The PRA requires that public records responsive to a public records request be promptly produced unless the PRA or an "other statute" exempts such records from production. This Agreement is not intended to alter COMMERCE's obligations under the PRA. The parties agree that if COMMERCE receives a public records request for files that may include confidential information under General Terms and Conditions Section 34, COMMERCE will notify the other party of the request and of the date that the records will be released to the requester unless GRANTEE obtains a court order enjoining disclosure. If the GRANTEE fails to obtain the court order enjoining disclosure, COMMERCE may release the requested information on the date specified. If the GRANTEE obtains a court order from a court of competent jurisdiction enjoining disclosure pursuant to the PRA, COMMERCE shall maintain the confidentiality of the information per the court order.

**GENERAL TERMS AND CONDITIONS**  
**GENERAL GRANT**  
**STATE FUNDS**

**24. DEFINITIONS**

As used throughout this Grant, the following terms shall have the meaning set forth below:

- A. "Authorized Representative" shall mean the Director and/or the designee authorized in writing to act on the Director's behalf.
- B. "COMMERCE" shall mean the Department of Commerce.
- C. "GRANTEE" shall mean the entity identified on the Face Sheet performing service(s) under this Grant, and shall include all employees and agents of the GRANTEE.
- D. "Personal Information" shall mean information identifiable to any person, including, but not limited to, information that relates to a person's name, health, finances, education, business, use or receipt of governmental services or other activities, addresses, telephone numbers, social security numbers, driver license numbers, other identifying numbers, and any financial identifiers.
- E. "State" shall mean the state of Washington.
- F. "Subgrantee/subcontractor" shall mean one not in the employment of the GRANTEE, who is performing all or part of those services under this Grant under a separate Grant with the GRANTEE. The terms "subgrantee/subcontractor" refers to any tier.
- G. "Subrecipient" shall mean a non-federal entity that expends federal awards received from a pass-through entity to carry out a federal program, but does not include an individual that is a beneficiary of such a program. It also excludes vendors that receive federal funds in exchange for goods and/or services in the course of normal trade or commerce.
- H. "Vendor" is an entity that agrees to provide the amount and kind of services requested by COMMERCE; provides services under the grant only to those beneficiaries individually determined to be eligible by COMMERCE and, provides services on a fee-for-service or per-unit basis with contractual penalties if the entity fails to meet program performance standards.
- I. "Grant" and "Agreement" and "Contract" shall mean the entire written agreement between COMMERCE and the GRANTEE, including any attachments, exhibits, documents, or materials incorporated by reference, and any amendments executed by the parties.

**25. ACCESS TO DATA**

In compliance with RCW 39.26.180, the GRANTEE shall provide access to data generated under this Grant to COMMERCE, the Joint Legislative Audit and Review Committee, and the Office of the State Auditor at no additional cost. This includes access to all information that supports the findings, conclusions, and recommendations of the GRANTEE's reports, including computer models and the methodology for those models.

**26. ADVANCE PAYMENTS PROHIBITED**

No payments in advance of or in anticipation of goods or services to be provided under this Grant shall be made by COMMERCE.

**27. ALL WRITINGS CONTAINED HEREIN**

This Grant contains all the terms and conditions agreed upon by the parties. No other understandings, oral or otherwise, regarding the subject matter of this Grant shall be deemed to exist or to bind any of the parties hereto.

**28. AMENDMENTS**

This Grant may be amended by mutual agreement of the parties. Such amendments shall not be binding unless they are in writing and signed by personnel authorized to bind each of the parties.

**29. AMERICANS WITH DISABILITIES ACT (ADA) OF 1990, PUBLIC LAW 101-336, ALSO REFERRED TO AS THE "ADA" 28 CFR PART 35**

The GRANTEE must comply with the ADA, which provides comprehensive civil rights protection to individuals with disabilities in the areas of employment, public accommodations, state and local government services, and telecommunications.

**30. ASSIGNMENT**

Neither this Grant, nor any claim arising under this Grant, shall be transferred or assigned by the GRANTEE without prior written consent of COMMERCE.

**31. ATTORNEYS' FEES**

Unless expressly permitted under another provision of the Grant, in the event of litigation or other action brought to enforce Grant terms, each party agrees to bear its own attorney's fees and costs.

**32. AUDIT**

**A. General Requirements**

COMMERCE reserves the right to require an audit. If required, GRANTEEs are to procure audit services based on the following guidelines.

The GRANTEE shall maintain its records and accounts so as to facilitate audits and shall ensure that subgrantees also maintain auditable records.

The GRANTEE is responsible for any audit exceptions incurred by its own organization or that of its subgrantees.

COMMERCE reserves the right to recover from the GRANTEE all disallowed costs resulting from the audit.

Responses to any unresolved management findings and disallowed or questioned costs shall be included with the audit report. The GRANTEE must respond to COMMERCE requests for information or corrective action concerning audit issues within thirty (30) days of the date of request.

**B. State Funds Requirements**

In the event an audit is required, if the GRANTEE is a state or local government entity, the Office of the State Auditor shall conduct the audit. Audits of non-profit organizations are to be conducted by a certified public accountant selected by the GRANTEE.

The GRANTEE shall include the above audit requirements in any subcontracts.

In any case, the GRANTEE's records must be available for review by COMMERCE.

**C. Documentation Requirements**

The GRANTEE must send a copy of the audit report described above no later than nine (9) months after the end of the GRANTEE's fiscal year(s) by sending a scanned copy to [comacctoffice@commerce.wa.gov](mailto:comacctoffice@commerce.wa.gov) or a hard copy to:

Department of Commerce  
ATTN: Audit Review and Resolution Office  
1011 Plum Street SE  
PO Box 42525  
Olympia WA 98504-2525

In addition to sending a copy of the audit, when applicable, the GRANTEE must include:

- Corrective action plan for audit findings within three (3) months of the audit being received by COMMERCE.
- Copy of the Management Letter.

If the GRANTEE is required to obtain a Single Audit consistent with Circular A-133 requirements, a copy must be provided to COMMERCE; no other report is required.

### **33. BREACHES OF OTHER STATE CONTRACTS**

GRANTEE is expected to comply with all other contracts executed between GRANTEE and the State of Washington. A breach of any other agreement entered into between GRANTEE and the State of Washington may, in COMMERCE's discretion, be deemed a breach of this Agreement.

### **34. CONFIDENTIALITY/SAFEGUARDING OF INFORMATION**

- A.** "Confidential Information" as used in this section includes:
1. All material provided to the GRANTEE by COMMERCE that is designated as "confidential" by COMMERCE;
  2. All material produced by the GRANTEE that is designated as "confidential" by COMMERCE; and
  3. All personal information in the possession of the GRANTEE that may not be disclosed under state or federal law. "Personal information" includes but is not limited to information related to a person's name, health, finances, education, business, use of government services, addresses, telephone numbers, social security number, driver's license number and other identifying numbers, and "Protected Health Information" under the federal Health Insurance Portability and Accountability Act of 1996 (HIPAA).
- B.** The GRANTEE shall comply with all state and federal laws related to the use, sharing, transfer, sale, or disclosure of Confidential Information. The GRANTEE shall use Confidential Information solely for the purposes of this Grant and shall not use, share, transfer, sell or disclose any Confidential Information to any third party except with the prior written consent of COMMERCE or as may be required by law. The GRANTEE shall take all necessary steps to assure that Confidential Information is safeguarded to prevent unauthorized use, sharing, transfer, sale or disclosure of Confidential Information or violation of any state or federal laws related thereto. Upon request, the GRANTEE shall provide COMMERCE with its policies and procedures on confidentiality. COMMERCE may require changes to such policies and procedures as they apply to this Grant whenever COMMERCE reasonably determines that changes are necessary to prevent unauthorized disclosures. The GRANTEE shall make the changes within the time period specified by COMMERCE. Upon request, the GRANTEE shall immediately return to COMMERCE any Confidential Information that COMMERCE reasonably determines has not been adequately protected by the GRANTEE against unauthorized disclosure.
- C.** Unauthorized Use or Disclosure. The GRANTEE shall notify COMMERCE within five (5) working days of any unauthorized use or disclosure of any confidential information, and shall take necessary steps to mitigate the harmful effects of such use or disclosure.

### **35. CONFLICT OF INTEREST**

Notwithstanding any determination by the Executive Ethics Board or other tribunal, COMMERCE may, in its sole discretion, by written notice to the GRANTEE terminate this Grant Agreement if it is found after due notice and examination by COMMERCE that there is a violation of the Ethics in Public Service Act, Chapters 42.52 RCW and 42.23 RCW; or any similar statute involving the GRANTEE in the procurement of, or performance under this Grant Agreement.

Specific restrictions apply to contracting with current or former state employees pursuant to chapter 42.52 of the Revised Code of Washington. The GRANTEE and their subcontractor(s) must identify any person employed in any capacity by the state of Washington that worked on this Grant, or any matter related to the project funded under this Grant or any other state funded project, including but not limited to formulating or drafting legislation, participating in grant procurement, planning and

execution, awarding grants, or monitoring grants, during the 24 month period preceding the start date of this Grant. Any person identified by the GRANTEE and their subcontractors(s) must be identified individually by name, the agency previously or currently employed by, job title or position held, and separation date. If it is determined by COMMERCE that a conflict of interest exists, the GRANTEE may be disqualified from further consideration for the award of a Grant.

In the event this Grant Agreement is terminated as provided above, COMMERCE shall be entitled to pursue the same remedies against the GRANTEE as it could pursue in the event of a breach of the Grant Agreement by the GRANTEE. The rights and remedies of COMMERCE provided for in this clause shall not be exclusive and are in addition to any other rights and remedies provided by law. The existence of facts upon which COMMERCE makes any determination under this clause shall be an issue and may be reviewed as provided in the "Disputes" clause of this Grant Agreement.

### **36. COPYRIGHT PROVISIONS**

Unless otherwise provided, all Materials produced under this Grant shall be considered "works for hire" as defined by the U.S. Copyright Act and shall be owned by COMMERCE. COMMERCE shall be considered the author of such Materials. In the event the Materials are not considered "works for hire" under the U.S. Copyright laws, the GRANTEE hereby irrevocably assigns all right, title, and interest in all Materials, including all intellectual property rights, moral rights, and rights of publicity to COMMERCE effective from the moment of creation of such Materials.

"Materials" means all items in any format and includes, but is not limited to, data, reports, documents, pamphlets, advertisements, books, magazines, surveys, studies, computer programs, films, tapes, and/or sound reproductions. "Ownership" includes the right to copyright, patent, register and the ability to transfer these rights.

For Materials that are delivered under the Grant, but that incorporate pre-existing materials not produced under the Grant, the GRANTEE hereby grants to COMMERCE a nonexclusive, royalty-free, irrevocable license (with rights to sublicense to others) in such Materials to translate, reproduce, distribute, prepare derivative works, publicly perform, and publicly display. The GRANTEE warrants and represents that the GRANTEE has all rights and permissions, including intellectual property rights, moral rights and rights of publicity, necessary to grant such a license to COMMERCE.

The GRANTEE shall exert all reasonable effort to advise COMMERCE, at the time of delivery of Materials furnished under this Grant, of all known or potential invasions of privacy contained therein and of any portion of such document which was not produced in the performance of this Grant. The GRANTEE shall provide COMMERCE with prompt written notice of each notice or claim of infringement received by the GRANTEE with respect to any Materials delivered under this Grant. COMMERCE shall have the right to modify or remove any restrictive markings placed upon the Materials by the GRANTEE.

### **37. DISPUTES**

Except as otherwise provided in this Grant, when a dispute arises between the parties and it cannot be resolved by direct negotiation, either party may request a dispute hearing with the Director of COMMERCE, who may designate a neutral person to decide the dispute.

The request for a dispute hearing must:

- be in writing;
- state the disputed issues;
- state the relative positions of the parties;
- state the GRANTEE's name, address, and Grant number; and
- be mailed to the Director and the other party's (respondent's) Grant Representative within three (3) working days after the parties agree that they cannot resolve the dispute.



The respondent shall send a written answer to the requestor's statement to both the Director or the Director's designee and the requestor within five (5) working days.

The Director or designee shall review the written statements and reply in writing to both parties within ten (10) working days. The Director or designee may extend this period if necessary by notifying the parties.

The decision shall not be admissible in any succeeding judicial or quasi-judicial proceeding.

The parties agree that this dispute process shall precede any action in a judicial or quasi-judicial tribunal.

Nothing in this Grant shall be construed to limit the parties' choice of a mutually acceptable alternate dispute resolution (ADR) method in addition to the dispute hearing procedure outlined above.

**38. DUPLICATE PAYMENT**

COMMERCE shall not pay the GRANTEE, if the GRANTEE has charged or will charge the State of Washington or any other party under any other Grant, subgrant/subcontract, or agreement, for the same services or expenses. The GRANTEE certifies that work to be performed under this contract does not duplicate any work to be charged against any other grant, subgrant/subcontract, or agreement.

**39. GOVERNING LAW AND VENUE**

This Grant shall be construed and interpreted in accordance with the laws of the state of Washington, and the venue of any action brought hereunder shall be in the Superior Court for Thurston County.

**40. INDEMNIFICATION**

To the fullest extent permitted by law, the GRANTEE shall indemnify, defend, and hold harmless the state of Washington, COMMERCE, agencies of the state and all officials, agents and employees of the state, from and against all claims for injuries or death arising out of or resulting from the performance of the contract. "Claim" as used in this contract, means any financial loss, claim, suit, action, damage, or expense, including but not limited to attorney's fees, attributable for bodily injury, sickness, disease, or death, or injury to or the destruction of tangible property including loss of use resulting therefrom.

The GRANTEE'S obligation to indemnify, defend, and hold harmless includes any claim by GRANTEE'S agents, employees, representatives, or any subcontractor or its employees.

The GRANTEE'S obligation shall not include such claims that may be caused by the sole negligence of the State and its agencies, officials, agents, and employees. If the claims or damages are caused by or result from the concurrent negligence of (a) the State, its agents or employees and (b) the GRANTEE, its subcontractors, agents, or employees, this indemnity provision shall be valid and enforceable only to the extent of the negligence of the GRANTEE or its subcontractors, agents, or employees.

The GRANTEE waives its immunity under Title 51 RCW to the extent it is required to indemnify, defend and hold harmless the state and its agencies, officers, agents or employees.

**41. INDEPENDENT CAPACITY OF THE GRANTEE**

The parties intend that an independent contractor relationship will be created by this Grant. The GRANTEE and its employees or agents performing under this Grant Agreement are not employees or agents of the state of Washington or COMMERCE. The GRANTEE will not hold itself out as or claim to be an officer or employee of COMMERCE or of the state of Washington by reason hereof, nor will the GRANTEE make any claim of right, privilege or benefit which would accrue to such officer or employee under law. Conduct and control of the work will be solely with the GRANTEE.

**42. INDUSTRIAL INSURANCE COVERAGE**

The GRANTEE shall comply with all applicable provisions of Title 51 RCW, Industrial Insurance. If the GRANTEE fails to provide industrial insurance coverage or fails to pay premiums or penalties on behalf of its employees as may be required by law, COMMERCE may collect from the GRANTEE the full amount payable to the Industrial Insurance Accident Fund. COMMERCE may deduct the amount owed by the GRANTEE to the accident fund from the amount payable to the GRANTEE by COMMERCE under this Grant Agreement, and transmit the deducted amount to the Department of Labor and Industries, (L&I) Division of Insurance Services. This provision does not waive any of L&I's rights to collect from the GRANTEE.

**43. LAWS**

The GRANTEE shall comply with all applicable laws, ordinances, codes, regulations and policies of local and state and federal governments, as now or hereafter amended.

**44. LICENSING, ACCREDITATION AND REGISTRATION**

The GRANTEE shall comply with all applicable local, state, and federal licensing, accreditation and registration requirements or standards necessary for the performance of this Grant Agreement.

**45. LIMITATION OF AUTHORITY**

Only the Authorized Representative or Authorized Representative's delegate by writing (delegation to be made prior to action) shall have the express, implied, or apparent authority to alter, amend, modify, or waive any clause or condition of this Grant Agreement. Furthermore, any alteration, amendment, modification, or waiver of any clause or condition of this Grant Agreement is not effective or binding unless made in writing and signed by the Authorized Representative.

**46. NONCOMPLIANCE WITH NONDISCRIMINATION LAWS**

During the performance of this Grant, the GRANTEE shall comply with all federal, state, and local nondiscrimination laws, regulations and policies. In the event of the GRANTEE's non-compliance or refusal to comply with any nondiscrimination law, regulation or policy, this Grant may be rescinded, canceled or terminated in whole or in part, and the GRANTEE may be declared ineligible for further Grants with COMMERCE. The GRANTEE shall, however, be given a reasonable time in which to cure this noncompliance. Any dispute may be resolved in accordance with the "Disputes" procedure set forth herein. The funds provided under this contract may not be used to fund religious worship, exercise, or instruction. No person shall be required to participate in any religious worship, exercise, or instruction in order to have access to the facilities funded by this grant.

**47. PAY EQUITY**

The GRANTEE agrees to ensure that "similarly employed" individuals in its workforce are compensated as equals, consistent with the following:

- a. Employees are "similarly employed" if the individuals work for the same employer, the performance of the job requires comparable skill, effort, and responsibility, and the jobs are performed under similar working conditions. Job titles alone are not determinative of whether employees are similarly employed;
- b. GRANTEE may allow differentials in compensation for its workers if the differentials are based in good faith and on any of the following:
  - (i) A seniority system; a merit system; a system that measures earnings by quantity or quality of production; a bona fide job-related factor or factors; or a bona fide regional difference in compensation levels.
  - (ii) A bona fide job-related factor or factors may include, but not be limited to, education, training, or experience that is: Consistent with business necessity; not based on or derived from a gender-based differential; and accounts for the entire differential.
  - (iii) A bona fide regional difference in compensation level must be: Consistent with business necessity; not based on or derived from a gender-based differential; and account for the entire differential.

This Grant Agreement may be terminated by COMMERCE, if COMMERCE or the Department of Enterprise services determines that the GRANTEE is not in compliance with this provision.

**48. POLITICAL ACTIVITIES**

Political activity of GRANTEE employees and officers are limited by the State Campaign Finances and Lobbying provisions of Chapter 42.17a RCW and the Federal Hatch Act, 5 USC 1501 - 1508.

No funds may be used for working for or against ballot measures or for or against the candidacy of any person for public office.

**49. PUBLICITY**

The GRANTEE agrees not to publish or use any advertising or publicity materials in which the state of Washington or COMMERCE's name is mentioned, or language used from which the connection with the state of Washington's or COMMERCE's name may reasonably be inferred or implied, without the prior written consent of COMMERCE.

**50. RECAPTURE**

In the event that the GRANTEE fails to perform this Grant in accordance with state laws, federal laws, and/or the provisions of this Grant, COMMERCE reserves the right to recapture funds in an amount to compensate COMMERCE for the noncompliance in addition to any other remedies available at law or in equity.

Repayment by the GRANTEE of funds under this recapture provision shall occur within the time period specified by COMMERCE. In the alternative, COMMERCE may recapture such funds from payments due under this Grant.

**51. RECORDS MAINTENANCE**

The GRANTEE shall maintain books, records, documents, data and other evidence relating to this Grant and performance of the services described herein, including but not limited to accounting procedures and practices that sufficiently and properly reflect all direct and indirect costs of any nature expended in the performance of this Grant.

GRANTEE shall retain such records for a period of six years following the date of final payment. At no additional cost, these records, including materials generated under the Grant, shall be subject at all reasonable times to inspection, review or audit by COMMERCE, personnel duly authorized by COMMERCE, the Office of the State Auditor, and federal and state officials so authorized by law, regulation or agreement.

If any litigation, claim or audit is started before the expiration of the six (6) year period, the records shall be retained until all litigation, claims, or audit findings involving the records have been resolved.

**52. REGISTRATION WITH DEPARTMENT OF REVENUE**

If required by law, the GRANTEE shall complete registration with the Washington State Department of Revenue.

**53. RIGHT OF INSPECTION**

At no additional cost, the GRANTEE shall provide right of access to its facilities to COMMERCE, or any of its officers, or to any other authorized agent or official of the state of Washington or the federal government, at all reasonable times, in order to monitor and evaluate performance, compliance, and/or quality assurance under this Grant.

**54. SAVINGS**

In the event funding from state, federal, or other sources is withdrawn, reduced, or limited in any way after the effective date of this Grant and prior to normal completion, COMMERCE may terminate the

Grant under the "Termination for Convenience" clause, without the ten calendar day notice requirement. In lieu of termination, the Grant may be amended to reflect the new funding limitations and conditions.

**55. SEVERABILITY**

The provisions of this Grant are intended to be severable. If any term or provision is illegal or invalid for any reason whatsoever, such illegality or invalidity shall not affect the validity of the remainder of the Grant.

**56. SITE SECURITY**

While on COMMERCE premises, GRANTEE, its agents, employees, or subcontractors shall conform in all respects with physical, fire or other security policies or regulations.

**57. SUBGRANTING/SUBCONTRACTING**

Neither the GRANTEE nor any subgrantee/subcontractor shall enter into subgrants/subcontracts for any of the work contemplated under this Grant Agreement without obtaining prior written approval of COMMERCE. In no event shall the existence of the subgrant/subcontract operate to release or reduce the liability of the GRANTEE to COMMERCE for any breach in the performance of the GRANTEE's duties. This clause does not include Grants of employment between the GRANTEE and personnel assigned to work under this Grant.

Additionally, the GRANTEE is responsible for ensuring that all terms, conditions, assurances and certifications set forth in this agreement are carried forward to any subgrants/subcontracts. Every subgrant/subcontract shall include a term that COMMERCE and the State of Washington are not liable for claims or damages arising from a subgrantee's/subcontractor's performance of the subgrant/subcontract. GRANTEE and its subgrantees/subcontractors agree not to release, divulge, publish, transfer, sell or otherwise make known to unauthorized persons personal information without the express written consent of COMMERCE or as provided by law.

**58. SURVIVAL**

The terms, conditions, and warranties contained in this Grant that by their sense and context are intended to survive the completion of the performance, cancellation or termination of this Grant shall so survive.

**59. TAXES**

All payments accrued on account of payroll taxes, unemployment contributions, the GRANTEE's income or gross receipts, any other taxes, insurance or expenses for the GRANTEE or its staff shall be the sole responsibility of the GRANTEE.

**60. TERMINATION FOR CAUSE**

In the event COMMERCE determines the GRANTEE has failed to comply with the conditions of this Grant in a timely manner, COMMERCE has the right to suspend or terminate this Grant. Before suspending or terminating the Grant, COMMERCE shall notify the GRANTEE in writing of the need to take corrective action. If corrective action is not taken within 30 calendar days, the Grant may be terminated or suspended.

In the event of termination or suspension, the GRANTEE shall be liable for damages as authorized by law including, but not limited to, any cost difference between the original Grant and the replacement or cover Grant and all administrative costs directly related to the replacement Grant, e.g., cost of the competitive bidding, mailing, advertising and staff time.

COMMERCE reserves the right to suspend all or part of the Grant, withhold further payments, or prohibit the GRANTEE from incurring additional obligations of funds during investigation of the alleged compliance breach and pending corrective action by the GRANTEE or a decision by COMMERCE to terminate the Grant. A termination shall be deemed a "Termination for Convenience"

if it is determined that the GRANTEE: (1) was not in default; or (2) failure to perform was outside of his or her control, fault or negligence.

The rights and remedies of COMMERCE provided in this Grant are not exclusive and are, in addition to any other rights and remedies, provided by law.

#### **61. TERMINATION FOR CONVENIENCE**

Except as otherwise provided in this Grant, COMMERCE may, by ten (10) business days written notice, beginning on the second day after the mailing, terminate this Grant, in whole or in part. If this Grant is so terminated, COMMERCE shall be liable only for payment required under the terms of this Grant for services rendered or goods delivered prior to the effective date of termination.

#### **62. TERMINATION PROCEDURES**

Upon termination of this Grant, COMMERCE, in addition to any other rights provided in this Grant, may require the GRANTEE to deliver to COMMERCE any property specifically produced or acquired for the performance of such part of this Grant as has been terminated. The provisions of the "Treatment of Assets" clause shall apply in such property transfer.

COMMERCE shall pay to the GRANTEE the agreed upon price, if separately stated, for completed work and services accepted by COMMERCE, and the amount agreed upon by the GRANTEE and COMMERCE for (i) completed work and services for which no separate price is stated, (ii) partially completed work and services, (iii) other property or services that are accepted by COMMERCE, and (iv) the protection and preservation of property, unless the termination is for default, in which case the AUTHORIZED REPRESENTATIVE shall determine the extent of the liability of COMMERCE. Failure to agree with such determination shall be a dispute within the meaning of the "Disputes" clause of this Grant. COMMERCE may withhold from any amounts due the GRANTEE such sum as the AUTHORIZED REPRESENTATIVE determines to be necessary to protect COMMERCE against potential loss or liability.

The rights and remedies of COMMERCE provided in this section shall not be exclusive and are in addition to any other rights and remedies provided by law or under this Grant Agreement.

After receipt of a notice of termination, and except as otherwise directed by the AUTHORIZED REPRESENTATIVE, the GRANTEE shall:

1. Stop work under the Grant on the date, and to the extent specified, in the notice;
2. Place no further orders or subgrants/subcontracts for materials, services, or facilities except as may be necessary for completion of such portion of the work under the Grant that is not terminated;
3. Assign to COMMERCE, in the manner, at the times, and to the extent directed by the AUTHORIZED REPRESENTATIVE, all of the rights, title, and interest of the GRANTEE under the orders and subgrants/subcontracts so terminated, in which case COMMERCE has the right, at its discretion, to settle or pay any or all claims arising out of the termination of such orders and subgrants/subcontracts;
4. Settle all outstanding liabilities and all claims arising out of such termination of orders and subcontracts, with the approval or ratification of the AUTHORIZED REPRESENTATIVE to the extent AUTHORIZED REPRESENTATIVE may require, which approval or ratification shall be final for all the purposes of this clause;
5. Transfer title to COMMERCE and deliver in the manner, at the times, and to the extent directed by the AUTHORIZED REPRESENTATIVE any property which, if the Grant had been completed, would have been required to be furnished to COMMERCE;
6. Complete performance of such part of the work as shall not have been terminated by the AUTHORIZED REPRESENTATIVE; and
7. Take such action as may be necessary, or as the AUTHORIZED REPRESENTATIVE may direct, for the protection and preservation of the property related to this Grant, which is in the possession of the GRANTEE and in which COMMERCE has or may acquire an interest.

**63. TREATMENT OF ASSETS**

Title to all property furnished by COMMERCE shall remain in COMMERCE. Title to all property furnished by the GRANTEE, for the cost of which the GRANTEE is entitled to be reimbursed as a direct item of cost under this Grant, shall pass to and vest in COMMERCE upon delivery of such property by the GRANTEE. Title to other property, the cost of which is reimbursable to the GRANTEE under this Grant, shall pass to and vest in COMMERCE upon (i) issuance for use of such property in the performance of this Grant, or (ii) commencement of use of such property in the performance of this Grant, or (iii) reimbursement of the cost thereof by COMMERCE in whole or in part, whichever first occurs.

- A. Any property of COMMERCE furnished to the GRANTEE shall, unless otherwise provided herein or approved by COMMERCE, be used only for the performance of this Grant.
- B. The GRANTEE shall be responsible for any loss or damage to property of COMMERCE that results from the negligence of the GRANTEE or which results from the failure on the part of the GRANTEE to maintain and administer that property in accordance with sound management practices.
- C. If any COMMERCE property is lost, destroyed or damaged, the GRANTEE shall immediately notify COMMERCE and shall take all reasonable steps to protect the property from further damage.
- D. The GRANTEE shall surrender to COMMERCE all property of COMMERCE prior to settlement upon completion, termination or cancellation of this Grant

All reference to the GRANTEE under this clause shall also include GRANTEE'S employees, agents or subgrantees/subcontractors.

**64. WAIVER**

Waiver of any default or breach shall not be deemed to be a waiver of any subsequent default or breach. Any waiver shall not be construed to be a modification of the terms of this Grant unless stated to be such in writing and signed by Authorized Representative of COMMERCE.

**ATTACHMENT A - SCOPE OF WORK**

Funds awarded under this grant will be used for capital expenditures to complete the adaptation of conceptual plans into engineered construction plans to be shovel-ready for the Skamania County Courthouse Park Plaza project. Design will include future park amenities including an outdoor amphitheater, water feature, children’s splash pad, covered outdoor dining space, a picnic site, natural gas firepit, public ADA bathrooms, reintroduction of native landscaping, interpretive signage, and ADA accessible circulation through the park. Seasonal farmers market, high school band performances and other annual events will be moved off highway 14 and into the park.

The location of the project is 7121 E Loop Rd, Stevenson, WA 98648.

- Project activities will include and not be limited to: Architecture and Engineering

This project began in 2019 and is expected to be complete by December 2024.

Costs related to the work will only be reimbursed to the extent the work is determined by Commerce to be within the scope of the legislative appropriation.

CERTIFICATION PERFORMANCE MEASURE

The GRANTEE, by its signature, certifies that the declaration set forth above has been reviewed and approved by the GRANTEE’s governing body as of the date and year written below.

\_\_\_\_\_  
GRANTEE

\_\_\_\_\_  
TITLE

\_\_\_\_\_  
DATE





**ATTACHMENT B - CERTIFICATION OF THE AVAILABILITY OF FUNDS TO COMPLETE THE PROJECT**

<b>Type of Funding</b>	<b>Source Description</b>	<b>Amount</b>
Grant	Washington State Department of Commerce	\$147,000.00
<b><i>Other Grants</i></b>		
Grant #1		\$
<b>Total Other Grants</b>		<b>\$0.00</b>
<b><i>Other Loans</i></b>		
Loan #1		\$
<b>Total Loans</b>		<b>\$0.00</b>
<b><i>Other Local Revenue</i></b>		
Source #1		\$
<b>Total Local Revenue</b>		<b>\$0.00</b>
<b><i>Other Funds</i></b>		
Source #1		\$
<b>Total Other Funds</b>		<b>\$0.00</b>
<b>Total Project Funding</b>		<b>\$147,000.00</b>

CERTIFICATION PERFORMANCE MEASURE

The GRANTEE, by its signature, certifies that project funding from sources other than those provided by this Grant Agreement and identified above has been reviewed and approved by the GRANTEE's governing body or board of directors, as applicable, and has either been expended for eligible Project expenses, or is committed in writing and available and will remain committed and available solely and specifically for carrying out the purposes of this Project as described in elsewhere in this Grant Agreement, as of the date and year written below. The GRANTEE shall maintain records sufficient to evidence that it has expended or has access to the funds needed to complete the Project, and shall make such records available for COMMERCE's review upon reasonable request.

\_\_\_\_\_  
GRANTEE

\_\_\_\_\_  
TITLE

\_\_\_\_\_  
DATE



**ATTACHMENT C- CERTIFICATION OF THE PAYMENT AND REPORTING OF PREVAILING WAGES**

CERTIFICATION PERFORMANCE MEASURE

The GRANTEE, by its signature, certifies that all contractors and subcontractors performing work on the Project shall comply with prevailing wage laws set forth in Chapter 39.12 RCW, as applicable on the date the appropriation becomes effective, including but not limited to the filing of the “Statement of Intent to Pay Prevailing Wages” and “Affidavit of Wages Paid” as required by RCW 39.12.040. The GRANTEE shall maintain records sufficient to evidence compliance with Chapter 39.12 RCW, and shall make such records available for COMMERCE’s review upon request.

If any state funds are used by the GRANTEE for the purpose of construction, applicable State Prevailing Wages must be paid.

The GRANTEE, by its signature, certifies that the declaration set forth above has been reviewed and approved by the GRANTEE’s governing body as of the date and year written below.

\_\_\_\_\_  
GRANTEE

\_\_\_\_\_  
TITLE

\_\_\_\_\_  
DATE



**ATTACHMENT D - CERTIFICATION OF INTENT TO ENTER THE LEADERSHIP IN ENERGY AND ENVIRONMENTAL DESIGN (LEED) CERTIFICATION PROCESS**

CERTIFICATION PERFORMANCE MEASURE

The GRANTEE, by its signature, certifies that it will enter into the Leadership in Energy and Environmental Design certification process, as stipulated in RCW 39.35D, as applicable to the Project funded by this Grant Agreement. The GRANTEE shall, upon receipt of LEED certification by the United States Green Building Council, provide documentation of such certification to COMMERCE.

The GRANTEE, by its signature, certifies that the declaration set forth above has been reviewed and approved by the GRANTEE's governing body or board of directors, as applicable, as of the date and year written below.

**IF EXEMPT: DO NOT SIGN**

\_\_\_\_\_  
GRANTEE

\_\_\_\_\_  
TITLE

\_\_\_\_\_  
DATE

**RCW 4.96.020 Tortious conduct of local governmental entities and their agents—Claims—Presentment and filing—Contents.** (1) The provisions of this section apply to claims for damages against all local governmental entities and their officers, employees, or volunteers, acting in such capacity.

(2) The governing body of each local governmental entity shall appoint an agent to receive any claim for damages made under this chapter. The identity of the agent and the address where he or she may be reached during the normal business hours of the local governmental entity are public records and shall be recorded with the auditor of the county in which the entity is located. All claims for damages against a local governmental entity, or against any local governmental entity's officers, employees, or volunteers, acting in such capacity, shall be presented to the agent within the applicable period of limitations within which an action must be commenced. A claim is deemed presented when the claim form is delivered in person or is received by the agent by regular mail, registered mail, or certified mail, with return receipt requested, to the agent or other person designated to accept delivery at the agent's office. The failure of a local governmental entity to comply with the requirements of this section precludes that local governmental entity from raising a defense under this chapter.

(3) For claims for damages presented after July 26, 2009, all claims for damages must be presented on the standard tort claim form that is maintained by the office of risk management in the department of enterprise services, except as allowed under (c) of this subsection. The standard tort claim form must be posted on the department of enterprise services' website.

(a) The standard tort claim form must, at a minimum, require the following information:

- (i) The claimant's name, date of birth, and contact information;
- (ii) A description of the conduct and the circumstances that brought about the injury or damage;
- (iii) A description of the injury or damage;
- (iv) A statement of the time and place that the injury or damage occurred;
- (v) A listing of the names of all persons involved and contact information, if known;
- (vi) A statement of the amount of damages claimed; and
- (vii) A statement of the actual residence of the claimant at the time of presenting the claim and at the time the claim arose.

(b) The standard tort claim form must be signed either:

- (i) By the claimant, verifying the claim;
- (ii) Pursuant to a written power of attorney, by the attorney-in-fact for the claimant;
- (iii) By an attorney admitted to practice in Washington state on the claimant's behalf; or
- (iv) By a court-approved guardian or guardian ad litem on behalf of the claimant.

(c) Local governmental entities shall make available the standard tort claim form described in this section with instructions on how the form is to be presented and the name, address, and business hours of the agent of the local governmental entity. If a local governmental entity chooses to also make available its own tort claim form in lieu of the standard tort claim form, the form:

(i) May require additional information beyond what is specified under this section, but the local governmental entity may not deny a claim because of the claimant's failure to provide that additional information;

(ii) Must not require the claimant's social security number; and

(iii) Must include instructions on how the form is to be presented and the name, address, and business hours of the agent of the local governmental entity appointed to receive the claim.

(d) If any claim form provided by the local governmental entity fails to require the information specified in this section, or incorrectly lists the agent with whom the claim is to be filed, the local governmental entity is deemed to have waived any defense related to the failure to provide that specific information or to present the claim to the proper designated agent.

(e) Presenting either the standard tort claim form or the local government tort claim form satisfies the requirements of this chapter.

(f) The amount of damages stated on the claim form is not admissible at trial.

(4) No action subject to the claim filing requirements of this section shall be commenced against any local governmental entity, or against any local governmental entity's officers, employees, or volunteers, acting in such capacity, for damages arising out of tortious conduct until sixty calendar days have elapsed after the claim has first been presented to the agent of the governing body thereof. The applicable period of limitations within which an action must be commenced shall be tolled during the sixty calendar day period. For the purposes of the applicable period of limitations, an action commenced within five court days after the sixty calendar day period has elapsed is deemed to have been presented on the first day after the sixty calendar day period elapsed.

(5) With respect to the content of claims under this section and all procedural requirements in this section, this section must be liberally construed so that substantial compliance will be deemed satisfactory. [2015 c 225 § 6; 2012 c 250 § 2; 2009 c 433 § 1; 2006 c 82 § 3; 2001 c 119 § 2; 1993 c 449 § 3; 1967 c 164 § 4.]

**Purpose—Severability—1993 c 449:** See notes following RCW 4.96.010.

**CITY OF STEVENSON, WASHINGTON  
RESOLUTION NO. 2023-406**

**A RESOLUTION OF THE CITY COUNCIL OF STEVENSON APPROVING THE APPOINTMENT OF THE CITY ADMINISTRATOR AS THE AGENT TO RECEIVE CLAIMS ON BEHALF OF THE CITY OF STEVENSON**

**WHEREAS**, the City Council of the City of Stevenson intends to appoint the City Administrator and, in his/her absence, the person fulfilling the City Administrator’s role, as the agent to receive claims on behalf of the City of Stevenson as required by RCW 4.96.020(2); such designation shall be until such time as the City Council may designate some other agent for the receipt/service of claims.

**NOW, THEREFORE, BE IT RESOLVED** by the City Council of the City of Stevenson the City Administrator or, in his/her absence, the person fulfilling the role of City Administrator, is appointed as the agent to receive claims and accept service on behalf of the City of Stevenson; such designation shall be effective until such time as the City Council may designate some other agent for the receipt/service of claims.

Passed and adopted by the City of Stevenson City Council at a meeting of the council on the \_\_\_\_ day of \_\_\_\_\_, 2023.

SIGNED:

ATTEST:

\_\_\_\_\_  
Scott Anderson  
Mayor of Stevenson

\_\_\_\_\_  
Leana Kinley  
Clerk/Treasurer

APPROVED AS TO FORM:

\_\_\_\_\_  
Robert C. Muth  
City Attorney

Agent Appointed: City Administrator  
City of Stevenson  
7121 E. Loop Rd/PO Box 371  
Stevenson, WA 98648

Business Hours: Monday through Thursday, 7:30 a.m. to 5 p.m.  
Closed weekends and official city holidays



**ADDENDUM #2  
INTERLOCAL AGREEMENT FOR BUILDING INSPECTION AND PLAN  
REVIEW SERVICES BETWEEN THE CITY OF STEVENSON AND  
SKAMANIA COUNTY**

**WHEREAS**, the City of Stevenson (“City”) has a need for permit software services, and

**WHEREAS**, Skamania County and the City have an existing interlocal agreement to provide the services of a building inspector and associated software program for building permits. The existing interlocal agreement remains in full force and effect, and

**WHEREAS**, the City has a need to add permit types to the existing platform to improve efficiencies and provide greater transparency around all permits within the City, and

**WHEREAS**, the County is willing to allow the City access to the County’s permitting software and add to the platform needs for the City under certain terms and conditions.

**NOW, THEREFORE**, in consideration of the terms and conditions set forth below it is agreed as follows:

- 1) The existing 2020 interlocal agreement shall be amended to include the following services:
  - a. Access for City staff to the following modules for permitting processes within the City.
    - i. Code Enforcement
    - ii. Planning
    - iii. Building
- 2) The City shall compensate the County for these additional services at the rate of 15% of the subscription charges from Cloudpermit® for:
  - a. Implementation fee
  - b. Code Enforcement Module
  - c. Planning Module
  - d. Building Module
- 3) The City will maintain necessary records and keep them according to the City’s retention policy.
- 4) This addendum shall take effect upon the signature of the last party signing the same and shall continue in full force and effect thereafter until December 31, 2024, or unless terminated by one of the parties as provided in the interlocal agreement.

**[Signatures appear on next page]**

**IN WITNESS WHEREOF**, the parties hereto have executed this addendum as of \_\_\_\_\_, 2023.

**CITY OF STEVENSON**, a Washington  
Municipal Corporation

**SKAMANIA COUNTY**, a Legal Subdivision of  
the State of Washington

Board of Commissioners

By: \_\_\_\_\_  
Scott Anderson, Mayor

By: \_\_\_\_\_  
Chairman

By: \_\_\_\_\_  
Commissioner

By: \_\_\_\_\_  
Commissioner

ATTEST:

By: \_\_\_\_\_  
Leana Kinley, City Clerk

By: \_\_\_\_\_  
Lisa Sackos,  
Clerk of the Board

APPROVED AS TO FORM:

\_\_\_\_\_  
Robert C. Muth  
City Attorney

\_\_\_\_\_  
Adam Kick, Prosecuting Attorney

2023 Proposed Council Workshop topics (pulled from AWC's e-learning website [here](#))

Jan 11, 2023 Community planning and development 101 for elected officials (55 min)  
<https://wacities.org/events-education/elearning-by-category/elearning-articles/2018/08/02/community-planning-and-development-101-for-elected-officials>

Feb 8, 2023 Parking Topic-Deep Dive

Mar 8, 2023 PRA (40 min) <https://wacities.org/data-resources/public-records-act-elearning>

Apr 12, 2023 Council retreat/workshop for 2024 priorities

May 10, 2023 Utility Rate Setting basics for elected officials (55 min)  
<https://wacities.org/events-education/elearning-by-category/elearning-articles/2020/08/21/utility-rate-setting-basics-for-elected-officials>

Jun 14, 2023 OPMA (45 min) <https://wacities.org/data-resources/open-public-meetings-act-elearning>

Jul 12, 2023 Finance 101 for elected officials (60 min)  
<https://wacities.org/events-education/elearning-by-category/elearning-articles/2018/05/23/finance-101-for-elected-officials>

Aug 9, 2023 Fundamentals of municipal budget cycles (52 min)  
<https://wacities.org/events-education/elearning-by-category/elearning-articles/2020/03/07/fundamentals-of-municipal-budget-cycles>

Sep 13, 2023 Budgeting basics  
<https://wacities.org/data-resources/budget-basics>

Oct 11, 2023 Affordable Housing Tools deep dive

Nov 8, 2023 Special Budget Meeting on 2024 budget

Dec 14, 2023 Elected officials essentials (specific selections-4 hours total)  
<https://wacities.org/data-resources/elected-officials-essentials-workshop>

Other Topics-

Snow Removal

**ENVIRONMENTAL MITIGATION AGREEMENT  
(Extension of Sewer Line on NW Iman Cemetery Road)**

This Agreement ("Agreement") is made and entered into this \_\_\_\_\_ day of March, 2023 by and between the City of Stevenson, a municipal corporation duly organized and validly existing under the laws of the State of Washington ("City"),

and

Adam Miller, who owns fee title to 195 NW Iman Cemetery Road, Stevenson, Washington 98648 ("Property Owner") and Gorge Dirt Works, LLC, WA UBI No. 603 400 979, WA Contractors License No. GORGEDW861LF ("Contractor").

**RECITALS**

WHEREAS, the Property Owner has submitted a building permit application for the construction of a single family residence at 195 NW Iman Cemetery Road ("the Property").

WHEREAS, as a condition of approving the building permit, the City requires the Property Owner to extend a section of the City's sewer line from the existing manhole at Angel Heights and Iman Cemetery to the intersection of Iman Loop and Iman Cemetery ("the Work"). The Work is further detailed in the Iman Cemetery Road Sewer Line Extension engineering plan prepared by Pioneer Surveying & Engineering, Inc. dated October 11, 2022 ("the Plans").

WHEREAS, the Property Owner has agreed to engage Contractor to perform the Work according to the Plans. The Work shall be done at the cost and expense of the Property Owner based on the terms of this Agreement. Upon completion and acceptance of the Work by the City, the City will reimburse the Property Owner for the verified costs and expenses associated with the Work.

WHEREAS, the City finds the Work as being necessary to mitigate environmental impacts related to the development of the real property and to relocate and reconstruct a service line in the area that poses a future risk to public health and safety.

WHEREAS, this Agreement is entered pursuant to chapter 43.21C RCW, the State Environmental Policy Act ("SEPA") and SMC Title 18, Environment. This Agreement provides for the mitigation of existing, known and anticipated environmental impacts which are associated with the construction of the single family residence. This Agreement is not, and shall not be construed as, a voluntary agreement pursuant to RCW 82.02.020.

WHEREAS, the City and Property Owner have determined it is in their interest to work together to eliminate potential public health and safety issues.

WHEREAS, Property Owner and Contractor hereby agrees to comply with all requirements of the City's construction standards and any other City resolutions, ordinances, policy or master plan.

NOW THEREFORE, in consideration of the mutual promises, covenants and agreements contained herein, the City, Property Owner and Contractor mutually undertake, promise and agree for themselves, their successors and assigns as follows:

**ARTICLE I  
INCORPORATION INTO AGREEMENT**

SECTION 1.01. The foregoing recitals are hereby ratified and conformed as being true and correct and are hereby made a specific part of this Agreement.

**ARTICLE II  
CONSTRUCTION OF UTILITY IMPROVEMENT**

SECTION 2.01. CITY'S OBLIGATIONS.

- (A) Inspection, General: The City, at its sole cost and expense, shall retain or use the services of a Washington State registered professional engineer for the purposes of inspecting and supervising the construction and installation of the Work to insure compliance with accepted civil engineering practices and the approved Plans. Prior to Property Owner and Contractor conveying the Work to the City, the engineer shall certify in writing the construction and installation of the Work complies with accepted civil engineering practices and are in substantial conformance with the approved Plans. The City is obligated to make inspections of all the construction work performed by the Contractor and permitted by the City under the terms of this Agreement. Such inspections shall not be construed to constitute any guarantee on the part of the City as to materials or workmanship, nor shall any inspection relieve the Contractor of the responsibility for the proper construction of the Work in accordance with the requirements of the approved Plans nor shall any inspections, if undertaken, abrogate the Contractor's one (1) year warranty to the City as to the quality and condition of the materials and workmanship as set forth below.
- (B) Inspection, Special: When required, the Contractor shall retain the services of licensed inspectors for any special inspections, including but not limited to testing of materials and compaction, as outlined in the Plans.
- (C) Reimbursement. Upon completion and acceptance of the Work, the City shall reimburse the Property Owner for all verified costs to undertake and complete the Work, including engineering and project management costs which may have occurred prior to this Agreement but related to the Work. The City shall reimburse the Property Owner 68% of project costs excluding costs associated solely with City or Property Owner portions of the Work.

## SECTION 2.02 PROPERTY OWNER AND CONTRACTOR'S OBLIGATIONS

- (A) Design: The Property Owner, at his sole cost and expense, with the aid of a Washington State registered professional engineer, shall be responsible for designing and preparing the Plans and any specifications associated with the Work. All plans, specifications, and calculations submitted for review shall be sealed and signed by a Washington State registered professional engineer. No work shall commence until the Plans and any specifications are approved in writing by the City and a construction permit issued.
- (B) Construction and Installation: The Property Owner and the Contractor, at their sole cost and expense, shall construct and install the Work in accordance with the approved Plans and specifications.
- (C) Compliance with Applicable Laws: The Work shall be performed in accordance with all requirements of the regulatory agencies which have jurisdiction over the subject matter of this Agreement as well as all applicable Federal laws, State statutes, County and City ordinances. The requirements of this paragraph shall govern, regardless of any errors or omissions in the approved Plans and specifications.
- (D) Approvals and Permits: The Property Owner or its agents, at their sole cost and expense, shall be fully responsible for obtaining all required approvals from all governmental agencies and for obtaining all necessary construction permits for the Work contemplated in the approved Plans and specifications.
- (E) Accuracy of Information: The Property Owner and Contractor shall furnish to the City accurate information with regard to all matters under this Agreement, including, without limitation, information contained in the Plans and specifications. The Property Owner and the Contractor shall be jointly and severally responsible for errors or changes in the information furnished to the City under this Agreement.
- (F) Compliance with City Code: Property Owner and Contractor acknowledge they have reviewed and agree to be bound by all applicable requirements of the City codes and standards
- (G) Warranty. The Property Owner and Contractor jointly and severally warranty the Work shall be performed in a good and workmanlike manner and in accordance with

all recognized industry standards. The warranty shall be for labor and materials for a period of one (1) year from the date the City accepts the Work as completed.

SECTION 2.03. INSURANCE. Contractor shall provide evidence to the City of the following insurance:

- (A) General liability insurance shall be provided on an "occurrence" basis, in the following limits of liability as a minimum: (1) bodily injury, \$1,000,000 each occurrence and \$2,000,000 each aggregate, and (2) property damage, \$1,000,000 each occurrence and \$2,000,000 each aggregate.
- (B) All policies shall provide they cannot be canceled or materially altered except after 30 days advance written notice to the City and shall name the City as an additional insured.
- (C) Contractor shall provide a Certificate of Insurance evidencing the City is a named Additional Insured on the general liability policy.

SECTION 2.04. CONVEYANCE OF THE WORK TO THE CITY. Upon completion and approval of the Work, the Contractor shall convey the Work to the City. Delivery to and acceptance by the City Council of all documents and related materials required for the Work shall constitute final acceptance by the City of these improvements.

The City shall provide reimbursement to the Property Owner within 30 calendar days of final acceptance.

### ARTICLE III GENERAL PROVISIONS

SECTION 3.01. Nothing contained herein shall be deemed to waive or modify any other lawful code provision, ordinance, resolution or regulation of the City nor shall this Agreement be applied in a manner which causes the City to violate any bond covenant or obligation.

SECTION 3.02. ASSIGNMENT, CONVEYANCES OR TRANSFERS OF THIS AGREEMENT. The partial or full assignment, conveyance or transfer of Property Owner and Contractor's rights and/or obligations under this Agreement shall be prohibited unless and until all of the following conditions are met:

- (A) It is in writing in a form approved by the City Council;
- (B) The City consents in writing, which consent shall not be unreasonably withheld and is a party to said assignment, to the conveyance or transfer and the assignee, conveyee or transferee agrees to abide by all the terms and provisions of this Agreement;
- (C) The Property Owner and Contractor are not in default under this Agreement; and
- (D) Such rights and/or obligations are assumed in writing by an assignee or transferee in a form acceptable to the City.

SECTION 3.03. NOTICES. All notices hereunder must be in writing and shall be mailed as follows;

For the City of Stevenson:                      City Administrator  
7121 E. Loop Road  
Stevenson, WA 98648

For the Property Owner:                      Adam Miller  
5940 NE Simpson Street  
Portland, Oregon 97218

For the Contractor:

Dayne Connell  
Gorge Dirt Works, LLC  
PO Box 732  
White Salmon, WA 98672

Notice so addressed and sent by prepaid certified mail, with return receipt requested, shall be deemed validly given when deposited in the United States mail.

SECTION 3.04. DEFAULT. The occurrence of any of the following during this Agreement shall constitute a default:

- (A) Property Owner or Contractor's failure in the performance or observance of any of the terms and conditions of this Agreement; or
- (B) There shall be filed by or against Property Owner and/or Contractor in any court or other tribunal pursuant to any governmental requirement, a petition in bankruptcy or insolvency proceedings or for reorganization or for the appointment of a receiver or trustee of all or substantially all of Property Owner or Contractor's assets.

In the event of Property Owner or Contractor's default under this Agreement, the City's obligations shall be voidable at the option of the City.

SECTION 3.05. REMEDIES. Should the Property Owner or Contractor be in default of this Agreement, it is agreed the City shall be entitled to any and all remedies under Washington State law, and in addition thereto, the City shall be entitled to any or all of the following remedies, which are cumulative:

- (A) Refusal to provide a final inspection or acceptance of the Work.

SECTION 3.06. MISCELLANEOUS PROVISIONS.

- (A) This Agreement constitutes the entire agreement between the Parties for all matters contained herein and shall supersede all previous agreements or representations either oral or written with respect to all matters contained herein. All prior agreements between the City and the Property Owner pertaining to any matters specifically covered by this Agreement are hereby canceled and declared of no force and effect to the extent they are in conflict herewith.
- (B) If any section, subsection, sentence, clause, phrase or portion of this Agreement is for any reason held invalid or unconstitutional by any court of competent jurisdiction, such portion shall be deemed a separate, distinct and independent provision and such holding shall not affect the validity of the remaining portions hereof.
- (C) The headings and subheadings use throughout this Agreement are for convenience only and have no significance in the interpretation of the body of this Agreement, and the Parties hereto agree that they be disregarded in construing the provisions of this Agreement.
- (D) The recitals to this Agreement are true and correct and are hereby incorporated as an integral and material part of this Agreement.
- (E) The signature of any person to this Agreement shall be deemed a personal warranty by that person he or she has the power and authority to bind any corporation, partnership or any other business entity for which he or she purports to acts.
- (F) In the event of any disputes and/or litigation arising from this Agreement, the prevailing party shall be awarded reasonable attorney's fees and costs (including paralegal) at trial and through and including appeals.





STATE OF WASHINGTON        )  
  ) SS:  
COUNTY OF SKAMANIA        )

Before me personally appeared Adam Miller well known and known to me to be the persons described in and who executed the foregoing instrument, and acknowledged to and before me that he executed said instrument for the purposes therein expressed.

Witness my hand and official seal this \_\_\_\_\_ day of \_\_\_\_\_, 2023.

\_\_\_\_\_  
Notary Public  
For the State of Washington  
My Commission Expires:

THIS AGREEMENT HAS BEEN APPROVED BY GORGE DIRT WORKS, LLC, ON MARCH \_\_\_\_, 2023.

STATE OF WASHINGTON        )  
  ) SS:  
COUNTY OF SKAMANIA        )

Before me personally appeared Dayne Connell, Authorized Representative for Gorge Dirt Works, LLC, well known and known to me to be the persons described in and who executed the foregoing instrument, and acknowledged to and before me that they executed said instrument for the purposes therein expressed.

Witness my hand and official seal this \_\_\_\_\_ day of \_\_\_\_\_, 2023.

\_\_\_\_\_  
Notary Public  
For the State of Washington  
My Commission Expires:

**CITY OF STEVENSON  
RESOLUTION NO. 2023-407  
A RESOLUTION OF THE CITY OF STEVENSON  
REVISING THE PERSONNEL POLICY**

**WHEREAS**, the City has in place a personnel policy that is in need of updates based on revising job descriptions; and

**WHEREAS**, the City Council finds the adoption of this resolution to be in the best interest of all city employees.

**NOW, THEREFORE**, be it resolved that the City Council of the City of Stevenson, Washington, hereby adopts the following policies as described and revised in Exhibit A, attached hereto and incorporated by reference, for the benefit of employees and managers.

Key: ~~Strikethrough~~ means repealed. Underlined means new.

APPROVED AND PASSED by the City Council of the City of Stevenson, Washington at its regular meeting this 16<sup>th</sup> day of March, 2023.

\_\_\_\_\_  
Mayor of the City of Stevenson

ATTEST:

\_\_\_\_\_  
Clerk of the City of Stevenson

APPROVED AS TO FORM:

\_\_\_\_\_  
Attorney for the City of Stevenson

# Exhibit A



## City of Stevenson Personnel Policy

Revised ~~December~~ March 16, 2023~~2~~



# City of Stevenson Personnel Policy

## Contents

RECEIPT OF PERSONNEL POLICIES .....	<u>77</u>
CHAPTER 1: PURPOSE AND SCOPE.....	<u>88</u>
1.1 INTRODUCTION .....	<u>88</u>
1.2 INTENT OF POLICIES .....	<u>88</u>
1.3 SCOPE OF POLICIES .....	<u>88</u>
1.4 CHANGING OF POLICIES.....	<u>99</u>
1.5 DEFINITIONS.....	<u>99</u>
CHAPTER 2: GENERAL POLICIES & PRACTICES .....	<u>1212</u>
2.1 EQUAL EMPLOYMENT OPPORTUNITY POLICY .....	<u>1212</u>
2.2 DISABILITY DISCRIMINATION PROHIBITED.....	<u>1212</u>
2.3 LIFE THREATENING/COMMUNICABLE DISEASES .....	<u>1212</u>
2.4 ANTI-HARASSMENT POLICY .....	<u>1212</u>
2.5 SEXUAL HARASSMENT PROHIBITED.....	<u>1313</u>
2.6 DISCRIMINATION COMPLAINT PROCEDURE .....	<u>1313</u>
2.7 EMPLOYEE RECORDS.....	<u>1414</u>
2.8 EMPLOYMENT REFERENCES.....	<u>1414</u>
CHAPTER 3: RECRUITING & HIRING.....	<u>1515</u>
3.1 RECRUITING .....	<u>1515</u>
3.2 HIRING.....	<u>1515</u>
3.3 TEMPORARY EMPLOYEES .....	<u>1616</u>
3.4 TRIAL PERIOD .....	<u>1616</u>
3.5 EMPLOYMENT OF RELATIVES (NEPOTISM) .....	<u>1717</u>
3.6 PROMOTIONS.....	<u>1717</u>
CHAPTER 4: HOURS & ATTENDANCE.....	<u>1818</u>
4.1 WORKING HOURS.....	<u>1818</u>
4.2 HOURS OF WORK AND OVERTIME .....	<u>1818</u>
4.3 COMPENSATORY TIME .....	<u>1919</u>
4.4 ATTENDANCE.....	<u>1919</u>
4.5 UNUSUAL CONDITIONS .....	<u>1919</u>
4.6 BREAKS AND MEAL PERIODS .....	<u>2020</u>
4.7 CALL BACK.....	<u>2020</u>
4.8 PAYROLL RECORDS.....	<u>2020</u>



# City of Stevenson Personnel Policy

CHAPTER 5: COMPENSATION.....	<u>2124</u>
5.1 SALARY CLASSIFICATION AND GRADES .....	<u>2124</u>
5.2 EMPLOYEE PAY RATES.....	<u>2124</u>
5.3 CERTIFICATION PAY .....	<u>2124</u>
5.4 OUT OF CLASS PAY .....	<u>2222</u>
5.5 ON CALL PAY .....	<u>2222</u>
5.4 PAYDAYS AND PAY PERIODS .....	<u>2323</u>
5.5 DEDUCTIONS.....	<u>2323</u>
5.6 TRAVEL AND TRANSPORTATION REGULATIONS .....	<u>2323</u>
5.7 COMPENSATION UPON TERMINATION.....	<u>2525</u>
CHAPTER 6: TRAINING & PERFORMANCE EVALUATIONS .....	<u>2626</u>
6.1 TRAINING .....	<u>2626</u>
6.2 PERFORMANCE EVALUATIONS.....	<u>2626</u>
CHAPTER 7: BENEFITS POLICY .....	<u>2727</u>
7.1 RETIREMENT BENEFITS.....	<u>2727</u>
7.2 DISABILITY BENEFITS (WORKERS COMPENSATION).....	<u>2727</u>
7.3 HEALTH INSURANCE BENEFITS .....	<u>2727</u>
7.4 CONTINUATION OF INSURANCE COVERAGE .....	<u>2828</u>
7.5 UNEMPLOYMENT COMPENSATION.....	<u>2929</u>
7.6 FIRE/EMERGENCY CALLS .....	<u>2929</u>
7.7 BOOT ALLOWANCE .....	<u>2929</u>
CHAPTER 8: LEAVES.....	<u>3030</u>
8.1 VACATION LEAVE.....	<u>3030</u>
8.2 SICK LEAVE .....	<u>3030</u>
8.3 LEAVE WITHOUT PAY.....	<u>3131</u>
8.4 JURY AND WITNESS LEAVE .....	<u>3232</u>
8.5 ADMINISTRATIVE LEAVE .....	<u>3232</u>
8.6 MILITARY LEAVE.....	<u>3232</u>
8.7 FAMILY LEAVE .....	<u>3232</u>
8.8 BEREAVEMENT LEAVE.....	<u>3535</u>
8.9 SHARED LEAVE PROGRAM.....	<u>3535</u>
8.10 HOLIDAYS .....	<u>3636</u>
8.11 RELIGIOUS HOLIDAYS .....	<u>3636</u>
8.12 BENEFITS FOR PART-TIME AND TEMPORARY EMPLOYEES...	<u>3636</u>



# City of Stevenson Personnel Policy

CHAPTER 9: EMPLOYEE RESPONSIBILITIES & CONDUCT .....	<u>3838</u>
9.1    GENERAL CODE OF CONDUCT.....	<u>3838</u>
9.2    OUTSIDE EMPLOYMENT AND CONFLICTS OF INTEREST .....	<u>3838</u>
9.3    CODE OF CONDUCT .....	<u>3838</u>
9.4    REPORTING IMPROPER GOVERNMENTAL ACTION.....	<u>3939</u>
9.5    POLITICAL ACTIVITIES.....	<u>3939</u>
9.6    NO SMOKING POLICY.....	<u>3939</u>
9.7    PERSONAL POSSESSIONS AND ELECTRONIC COMMUNICATIONS <u>3939</u>	
9.8    USE OF CITY VEHICLES AND EQUIPMENT .....	<u>4040</u>
9.9    USE OF CITY CREDIT CARDS (Ref. Resolution No. 132).....	<u>4040</u>
9.10   CONTACT WITH THE NEWS MEDIA .....	<u>4141</u>
9.11   DRIVER’S LICENSE REQUIREMENTS.....	<u>4141</u>
9.12   SOLICITATIONS.....	<u>4141</u>
9.13   SAFETY .....	<u>4242</u>
9.14   DRUG-FREE WORKPLACE .....	<u>4242</u>
9.15   DRUG & ALCOHOL TESTING POLICY & PROCEDURES.....	<u>4343</u>
10.1   ACTIONS SUBJECT TO DISCIPLINARY ACTION .....	<u>5454</u>
10.2   POSSIBLE DISCIPLINARY ACTIONS .....	<u>5555</u>
10.3   PRE-TERMINATION HEARING .....	<u>5555</u>
10.4   LAYOFF .....	<u>5656</u>
10.5   RESIGNATION OR RETIREMENT.....	<u>5656</u>
CHAPTER 11: COMPLAINT PROCEDURES.....	<u>5757</u>
11.1   COMPLAINT PROCEDURES .....	<u>5757</u>
Appendix # A-1.....	<u>5858</u>
MEMORANDUM OF AGREEMENT .....	<u>5858</u>
Appendix # A-2.....	<u>5959</u>
SUPERVISOR GUIDES .....	<u>5959</u>
Appendix # A-3.....	<u>6060</u>
SEPARATION AGREEMENT (a).....	<u>6060</u>
SEPARATION AGREEMENT (b) .....	<u>6161</u>
Appendix # A-4: .....	<u>6363</u>
CELL PHONE POLICY.....	<u>6363</u>
Appendix # A-5.....	<u>6868</u>
Ordinance No. 879 .....	<u>6868</u>



## City of Stevenson Personnel Policy

Appendix # A-6.....	<a href="#">7174</a>
LIST OF AGENCIES .....	<a href="#">7174</a>
LOCAL <del>7174</del>	
STATE OR REGIONAL AGENCIES .....	<a href="#">7174</a>
FEDERAL AGENCIES.....	<a href="#">7272</a>
Appendix # A-7.....	<a href="#">7575</a>
TRAVEL REIMBURSEMENT REQUEST.....	<a href="#">7575</a>
Appendix # A-8.....	<a href="#">7676</a>
CITY ADMINISTRATOR.....	<a href="#">7676</a>
PUBLIC WORKS DIRECTOR.....	<a href="#">7979</a>
COMMUNITY DEVELOPMENT DIRECTOR.....	<a href="#">8383</a>
DEPUTY CLERK/TREASURER II.....	<a href="#">8686</a>
DEPUTY CLERK/TREASURER I.....	<a href="#">Error! Bookmark not defined.89</a>
PUBLIC WORKS FIELD SUPERVISOR.....	<a href="#">9595</a>
UTILITIES/MAINTENANCE WORKER.....	<a href="#">9898</a>
FACILITIES MAINTENANCE WORKER.....	<a href="#">102402</a>
WASTEWATER TREATMENT PLANT OPERATOR I.....	<a href="#">104104</a>
WASTEWATER TREATMENT PLANT OPERATOR II.....	<a href="#">107407</a>
WASTEWATER TREATMENT PLANT OPERATOR III .....	<a href="#">110410</a>
MINUTE TAKER.....	<a href="#">113413</a>
Appendix # A-9.....	<a href="#">115415</a>
CITY OF STEVENSON INTERNET/INTRANET, PERSONAL COMPUTER, VOICE MAIL AND E-MAIL USE POLICY .....	<a href="#">115415</a>
Appendix # A-10.....	<a href="#">123423</a>
CITY OF STEVENSON AUTHORIZING THE USE OF CREDIT CARDS. <del>123423</del>	
Appendix # A-11.....	<a href="#">125425</a>
Reasonable Suspicion Documentation Form.....	<a href="#">125425</a>
Appendix # A-12.....	<a href="#">126426</a>
Post-Accident Checklist.....	<a href="#">126426</a>
Appendix # A-13.....	<a href="#">127427</a>
Consent for Limited Queries of the FMCSA Drug and Alcohol Clearinghouse <a href="#">127427</a>	
Appendix # A-14.....	<a href="#">128428</a>
Driver Evaluation Matrix.....	<a href="#">128428</a>



# City of Stevenson Personnel Policy





## City of Stevenson Personnel Policy

# RECEIPT OF PERSONNEL POLICIES

All employees should read the following; then sign, date and return the form to your supervisor. The form will be placed in the employee's personnel file.

Enclosed are the City of Stevenson's personnel policies. It is your responsibility to read these policies, as they will acquaint you with your employee benefits, our personnel practices and rules, and some organizational philosophy.

It is important to understand that these policies do not create an employment contract or a guarantee of employment of any specific duration between the City and its employees. Although we hope that your employment relationship with us will be long term, we recognize that at times things do not always work out as hoped, and either of us may decide to terminate the employment relationship.

***At Will Notice: Unless specific rights are granted to you in employment contracts, civil service rules, or elsewhere, all employees of the City are considered at-will employees and may be terminated from City employment at any time, with or without cause and with or without notice.***

As the City grows and changes, personnel policies may change. The City, therefore reserves the right to revise, supplement, clarify or rescind any policy or portion of a policy when deemed appropriate by the Mayor or City Administrator. You will be notified of any such changes.

Please also understand that no supervisor, manager or representative of the City other than the Mayor or the City Administrator has the authority to make any written or verbal statements or representations which are inconsistent with these policies.

I hereby consent to deduction from my final paycheck of any amounts advanced to me that remain unearned when my employment with the City ends, including unearned vacation leave.

If you have any questions about these policies or any other policies of the City, please feel free to ask your supervisor, the Mayor or City Administrator.

I have read and understand the statements above.

\_\_\_\_\_  
Employee Signature

\_\_\_\_\_  
Date

Return one signed copy of this form to payroll.



# City of Stevenson Personnel Policy

## CHAPTER 1: PURPOSE AND SCOPE

### 1.1 INTRODUCTION

These personnel policies serve as a general guide to the City's current employment practices and procedures. As such, we hope they will help you better understand how the City operates and what is expected of you as an employee. These policies also describe what the City provides you in terms of compensation, benefits and other support.

The City places the highest value on our employees and their well-being. We want to see that you are a satisfied worker, with the support necessary to achieve the objectives of your position. Only in this manner can your contribution to the City organization be the most productive.

It is our belief that when consistent and equitable personnel policies are known and communicated to all the choices for greater job satisfaction increase. We encourage you to read these policies. If you have any questions, please ask your supervisor. As you have ideas or suggestions for improvement, please do the same.

### 1.2 INTENT OF POLICIES

These policies are not intended to be a contract, expressed or implied, or any type of promise or guarantee of specific treatment upon which you may rely, or as a guarantee of employment for any specific duration. Although we hope that your employment relationship with us will be long term, we recognize that things may not always work out as hoped, and either of us may decide to terminate the employment relationship. Unless specific rights are granted to you in employment contracts, civil service rules, or elsewhere, all employees for the City are considered at-will employees and may be terminated from City employment at any time, with or without cause and with or without notice. Please understand that no supervisor, manager or representative of the City other than the Mayor or City Administrator has the authority to enter into any agreement with you for employment for any specified period or to make any written or verbal commitments contrary to the foregoing.

### 1.3 SCOPE OF POLICIES

These personnel policies apply to all City employees. In cases where these policies conflict with any City ordinance, Civil Service rules and regulations, the provisions of a collective bargaining agreement, state or federal law, the terms of that law or agreement prevail. In all other cases, these policies apply.



# City of Stevenson Personnel Policy

## 1.4 CHANGING OF POLICIES

As the need arises, the City Council may modify these policies and any changes in compensation or benefit levels by Resolution. The Mayor or City Administrator may deviate from these policies in individual situations, particularly in an emergency, in order to achieve the primary mission of serving the City's citizens. Employees may request specific changes to these policies by submitting suggestions to their supervisor. Employees must be notified in writing of modifications or revisions to this policy within 30 days of adoption and provided a copy of the change.

## 1.5 DEFINITIONS

**Accident:** An incident involving City owned vehicles which resulted in damages amounting to at least \$1,000.00.

**Alcohol:** The intoxicating element of whiskey, beer, wine and other fermented or distilled liquors.

**Alcohol Use:** The consumption of any beverage, mixture or preparation, including any medication, containing alcohol.

**Child:** Biological, adopted, foster or stepchild or legal ward under 18 or a child older than 18 incapable of self-care. (See 7.3 for unique definition of dependent child as it relates to health insurance coverage).

**Class:** A group of positions sufficiently similar in duties, responsibilities, authority, and minimum qualifications to permit combining them under a single title, and to permit the application of common standards for selection and compensation.

**Commercial Driver:** Any employee who has a commercial driver's license (CDL) and who may operate a commercial motor vehicle on a regular or intermittent basis at the direction of, or with the consent of the City, including, but not limited to full or part-time, regularly appointed employees, and temporary or intermittent employees.

**Compensation Schedule.** A schedule of salary ranges of all position classes in the service of the city, including single position classes, setting forth the salary range for each such position in accordance with the criteria and procedures set forth in these rules and regulations and also setting forth the salary rates by step in each range.

**Compensatory Time Off.** Time off from work to compensate the employee for overtime worked.

**Controlled Substance/Drugs:** Prohibited drugs are any illegal controlled substance including, but not limited to, marijuana (THC), cocaine, opiates, phencyclidine (PCP), and amphetamines, as well as any drug not approved for medical use by the USDA or the



# City of Stevenson Personnel Policy

USFDA. Illegal use includes use of or impairment by any illegal drug, misuse of legally prescribed or over the counter drugs or illegally obtained prescription drugs.

**Department Head:** An employee designated by the Mayor with confirmation of the City Council to be responsible for management and supervision of a Department

**Impaired.** Under the influence of drugs or alcohol meeting or exceeding the standard of RCW 46.61.502(1), Driving Under the Influence, regardless of whether the employee is charged or convicted of the criminal conduct described therein.

**Medical Review Officer:** A licensed physician (medical doctor or doctor of osteopathy) responsible for receiving laboratory results generated by the City’s drug testing program who has knowledge of substance abuse disorders and has appropriate medical training to interpret and evaluate an individual’s confirmed positive test result together with his or her medical history of any other relevant biomedical information.

**Overnight Travel:** You must be more than 50 road miles from your home or work (one-hour travel time). Exceptions can be made by the supervisor in special circumstances such as:

- a) To avoid driving back and forth for back-to-back late night/early morning meetings.
- b) To avoid driving in inclement weather.

**Overtime.** Time worked in excess of the regularly scheduled 40-hour workweek.

**Parent:** Biological parent or someone who was “in loco parentis” a legal term meaning a person or entity that stands in place of a parent.

**Regular Full-Time Employee:** An employee who has successfully completed a trial period as defined in these policies and who regularly works a minimum of forty (40) hours a week.

**Regular Part-Time Employee:** An employee who has successfully completed a trial period as defined in these policies and who regularly works less than forty (40) but at least twenty (20) hours a week.

**Retirement:** The separation from service with the City of an employee who is retiring under regulations for the Washington State Department of Retirement systems or upon eligibility for full age retirement or early retirement benefits under Title II of the Social Security Act. The employee shall select which of these criteria to use for determination of retirement.

Memo: PERS 2

- 65 with five service credit years
- 55 with twenty service credit years

PERS 3

- 65 with 10 service credit years
- 55 with 10 service credit years



## City of Stevenson Personnel Policy

**Salary Range.** The range of salary rates for a position as set forth in the compensation plan as established by the legislative body of the City.

**Supervisor:** An employee who is responsible for directing one or more departments or staff members.

**Standby Pay:** An employee is required to remain at a specific location or in an immediate vicinity of a specific location and be prepared to report immediately to work if the need arises, although the need may not arise.

**Temporary Employee:** Employees who hold jobs of limited duration due to special projects, abnormal workloads or emergencies. Temporary employees are not eligible for City benefits.

**Trial Employee:** Employees who have not yet completed their trial period in a regular position and who have not been certified to regular employment status. Unless otherwise specified, when regular employees are referred to in these policies, they shall include trial employees.



## City of Stevenson Personnel Policy

### CHAPTER 2: GENERAL POLICIES & PRACTICES

#### 2.1 EQUAL EMPLOYMENT OPPORTUNITY POLICY

The City is an equal employment opportunity employer. The City employs, retains, promotes, terminates and otherwise treats all employees and job applicants on the basis of job-related qualifications and competence. These policies and all employment practices shall be applied without regard to any individual's sex, race, color, religion, national origin, pregnancy, age, marital status, or disability.

#### 2.2 DISABILITY DISCRIMINATION PROHIBITED

The City will not discriminate against qualified applicants or employees with a sensory, physical or mental disability, unless the disability cannot be reasonably accommodated and prevents proper performance of an essential element of the job. The City will reasonably accommodate qualified individuals with disabilities.

#### 2.3 LIFE THREATENING/COMMUNICABLE DISEASES

Employees with life threatening illnesses or communicable diseases are treated the same as all other employees. They are permitted to continue working as long as they are able to maintain an acceptable level of performance and medical evidence shows they are not a threat to themselves or their co-workers. The City will work to preserve the safety of all of its employees and reserves the right to reassign employees or take other job actions, including discharge, when a substantial and unusual safety risk to fellow City employees or the public exists.

#### 2.4 ANTI-HARASSMENT POLICY

It is the City's policy to foster and maintain a work environment that is free from discrimination and intimidation. Toward this end, the City will not tolerate harassment of any kind that is made by employees toward co-workers or to members of the public. Employees are expected to show respect to each other and the public at all times, despite individual differences.

Harassment is defined as a verbal or physical conduct that demeans or shows hostility or aversion toward another employee or members of the public. Examples of prohibited conduct include slurs or demeaning comments to employees or members of the public relating to race, ethnic background, gender, religion, sexual orientation, political ideology, age, or disability.



## City of Stevenson Personnel Policy

### 2.5 SEXUAL HARASSMENT PROHIBITED

Sexual harassment is a form of sex discrimination and is illegal. Sexual harassment is also inappropriate and offensive and will not be tolerated by the City.

Sexual harassment is behavior of a sexual nature which is unwelcome. Examples of sexual harassment include verbal behavior such as unwanted sexual comments, suggestions, jokes, or pressure for sexual favors; non-verbal behavior such as suggestive looks and leering; and physical behavior such as pats or squeezes, or repeatedly brushing against someone's body. Other conduct also may constitute sexual harassment depending upon given facts and circumstances.

Unwelcome sexual advances, requests for sexual favors, and other verbal or physical conduct constitute sexual harassment when:

- It is part of a manager's or supervisor's decision to hire or fire;
- It is used to make other employment decisions like pay, promotion, or job assignments;
- It creates an intimidating, hostile, or offensive work environment.

Employees engaging in improper harassment are subject to discipline, including termination.

### 2.6 DISCRIMINATION COMPLAINT PROCEDURE

Each member of management is responsible for creating an atmosphere free of discrimination and harassment, sexual or otherwise. Further, employees are responsible for respecting the rights of their co-workers and others, including the citizens they serve. The following procedure outlines the steps to follow if you believe you have experienced harassment or discrimination on the job.

Should you believe that you have been harassed or are the victim of discrimination, you should try, if possible, to identify the offensive behavior to the harasser and request that it stop. In the event such informal direct communication is either ineffective or impossible, you should discuss your concern **immediately** with the Mayor or the City Administrator. If supervisors or managers receive a report from an employee, they must document and refer to the Mayor or City Administrator as soon as possible. No employee will suffer retaliation for reporting such concern. To the extent possible, complaints will be handled confidentially.

If an investigation shows the accused employee or member of the public did engage in improper harassment or discrimination, appropriate action will be taken, as in the case of any other serious employee misconduct. Such actions may include warnings, verbal



## City of Stevenson Personnel Policy

and/or written reprimands, a letter to the employee's file or an employee transfer, demotion, suspension or termination.

### 2.7 EMPLOYEE RECORDS

A personnel file is maintained for each employee. An employee's personnel file(s) contains the employee's name, title and/or position held, job description, department to which the employee is assigned, changes in employment status, training received, performance evaluations, personnel actions affecting the employee, including discipline, and other pertinent information.

It is the City Administrator's responsibility to ensure complete personnel files are maintained for each employee to demonstrate legal requirements have been satisfied; to provide a basis for personnel actions; and to document the attainments of each employee.

Employees have the right to review their file. An employee may request removal of irrelevant or erroneous information in his/her personnel file. If the City denies the employee's request to remove the information, employees may file a written rebuttal statement to be placed in their file.

Personnel files are kept confidential to the maximum extent permitted by law. Except for routine verifications of employment, no information from an employee's personnel file will be released to the public, including the press, without a written request for specific information as regulated by the Washington State Public Disclosure Act.

### 2.8 EMPLOYMENT REFERENCES

Only the Mayor, the City Administrator or the supervisor will provide employment references on current or former City employees. Other employees shall refer request for references to the appropriate person. References will be limited to verification of employment and salary unless the employee has completed a written waiver and release.





# City of Stevenson Personnel Policy

## CHAPTER 3: RECRUITING & HIRING

### 3.1 RECRUITING

Recruiting practices are conducted solely on the basis of ability, merit, qualifications and competence, without regard to race, color, religion, national origin, sex, marital status, pregnancy, physical handicap, disability or age.

Each applicant shall complete and sign an application form prior to being considered for any position. Resumes may supplement, but not replace, the City's official application.

Any applicant supplying false or misleading information is subject to immediate termination, if hired. All statements submitted on the employment application shall be subject to investigation and verification prior to appointment.

### 3.2 HIRING

When a position becomes vacant or is newly created and prior to any posting or advertisement of the vacancy, the supervisor shall review the position, its job description and the need for such a position. The supervisor will prepare and submit a written request to fill the position to the City Administrator or the Mayor. The position will be posted in house and/or advertised only after the request is approved. All candidates for employment must file an employment application form with the City.

The City may administer pre-employment examinations to test the qualifications and ability of applicants, as determined necessary by the City, pre-employment drug tests and certain background checks as needed. Examples of such procedures include: requiring applicants/employees to show proof they are authorized to work in the United States, requiring applicants/employees who have unsupervised access to children or developmentally disabled adults to complete a disclosure statement and background check, or requiring applicants/employees who handle money to pass a background check.

Residency within the City shall not be a condition of initial appointment or continued employment; provided, however, that an employee's selection of residence shall not interfere with the daily performance of his/her duties and responsibilities.

Applicants for positions in which the applicant is expected to operate a motor vehicle must be at least 18 years old and will be required to present a valid driver's license with any necessary endorsements. Driving records of applicants may be checked. Applicants with poor driving records, as determined by the City, may be disqualified for employment with the City in positions requiring driving.

After an offer of employment has been made and prior to commencement of employment, the City may require persons selected for employment to successfully pass a medical examination which will include testing for alcohol and controlled substances.



## City of Stevenson Personnel Policy

The purpose of the examination is to determine if the individual is physically able to perform the job and to ensure his/her physical condition will not endanger the health, safety or well-being of other employees or the public. The offer of employment may be conditioned on the results of the examination.

A candidate may be disqualified from consideration if: (1) found physically unable to perform the duties of the position (and the individual's condition cannot reasonably be accommodated in the workplace); (2) the candidate refuses to submit to a medical examination or complete medical history form; or (3) if the exam reveals use of alcohol and/or controlled substances.

### 3.3 TEMPORARY EMPLOYEES

Supervisors may use temporary employees to temporarily replace regular employees who are on vacation or other leave, to meet peak work load or emergency needs, or to temporarily fill a vacancy until a regular employee is hired. Temporary employees may be hired without competitive recruitment or examination, although all hiring processes must comply with state and federal laws.

Compensation/Benefits: Temporary employees are eligible for overtime pay as required by law. Temporary employees do not receive vacation, health insurance, holidays or any other benefits during their employment.

Temporary employees pay contributions to the Social Security system, as does the City on their behalf. Temporary employees will not normally be placed on the state PERS retirement system, although there are a few exceptions depending on PERS eligibility criteria.

### 3.4 TRIAL PERIOD

Upon hire or appointment, all employees enter a trial period that is considered an integral part of the selection and evaluation process. The trial period is designed to give the employee time to learn the job and to give the supervisor time to evaluate whether the match between the employee and the job is appropriate. An employee on probation may be terminated by their supervisor without cause and is notified of such action in writing.

The normal trial period is six months from the employee's date of hire, rehire or promotion. The Mayor and/or the City Administrator may authorize the supervisor to extend the trial period for up to an additional six (6) months. An extension may be granted due to circumstances such as an extended illness, a continued need to evaluate an employee's performance, or the need to meet specific trainings and certifications.

There will be a performance review at mid-point and prior to the end of the probationary period to ensure that the employee is performing up to City standards.



## City of Stevenson Personnel Policy

Once the trial period is successfully completed, the employee may be certified to regular employment status. Satisfactory completion of the trial period does not create an employment contract or guarantee employment with the City for a specified duration.

**Use of Sick Leave/Vacation During Trial Period:** Trial employees may use their accrued sick leave from the beginning of their employment but may not use vacation until they have successfully completed their trial period, at which time they will be credited for six days of vacation. Certain employees may have training and certifications to get that are required over an extended period of time. These employees will have access to their vacation at the 6-month period.

### 3.5 EMPLOYMENT OF RELATIVES (NEPOTISM)

No parent, child, grandparent, grandchild, spouse, significant other or sibling shall be employed in the City's service in the same department as a current employee with exception of temporary emergency employment.

### 3.6 PROMOTIONS

The City encourages promotion from within the organization whenever possible. All openings will be posted so that employees may become aware of opportunities and apply for positions in which they are interested and qualified.

Before advertising a position to the general public, the Mayor or the City Administrator may choose to circulate a promotional opportunity within the City. This will not apply for temporary employees.

The City reserves the right to seek qualified applicants outside of the organization at its discretion.

To be considered for promotion, an employee must be employed in their position for at least six (6) months and meet the qualifications for the vacant position.

New Trial Period: After promotion to a new position, a new trial period of six (6) months must be completed, unless waived or reduced by the supervisor. In the case of unsatisfactory performance in a promotional situation, the employee may be considered for transfer back to the previous position held by the employee.



# City of Stevenson Personnel Policy

## CHAPTER 4: HOURS & ATTENDANCE

### 4.1 WORKING HOURS

The City's standard work week consists of 40 hours with an unpaid lunch period. Due to the nature of the City's operation, longer hours may be necessary in some instances.

A normal working schedule for regular, full-time employees consists of forty (40) hours each work week. Different work schedules may be established by the City to meet job assignments and provide necessary City services. Each employee's department head will advise the employee regarding his/her specific working hours.

Flexible scheduling will be considered with the approval of the appropriate department head and City Administrator. All requests will be evaluated against the need for continuity in access by and service to the citizens and the facilitation of staff teamwork.

Part-time and temporary employees will work hours as specified by their department heads.

### 4.2 HOURS OF WORK AND OVERTIME

All City positions are designated as either "exempt" or "non-exempt" according to the Fair Labor Standards Act ("FLSA") and Washington Minimum Wage Act regulations. You will be informed of your status by the City.

For most City employees, the established work period is forty (40) hours within a seven (7) day work week. In some instances, under the City's flexible scheduling, the department head may define a work week/work period as something other than the standard Monday through Sunday. All personnel are responsible for accurately reporting all hours worked on forms supplied by the City. Employees failing to accurately record time worked are subject to discipline.

Non-exempt employees are entitled to additional compensation, either in cash or compensatory time off, when they work more than the maximum numbers of hours during a work period. All overtime must be authorized in advance by the employee's department head. Overtime pay is calculated at one and one-half times the employee's regular rate of pay for all time worked beyond the established work period. When computing overtime, *time taken as compensatory time off*, is not counted as hours worked.

Neither the federal FLSA nor the state Minimum Wage Act (Ch 49.46) requires payment of overtime for work on a holiday. It is the City's practice to allow on call field staff to charge a minimum of two (2) hours of overtime for any call outs when on call. When that call out is on a holiday the rate of pay will be double time and a half (2 ½) rather than overtime for all call outs on a holiday.



## City of Stevenson Personnel Policy

Exempt employees are not covered by the FLSA or Washington Minimum Wage Act overtime provisions and do not receive either overtime pay or compensatory time in lieu of overtime pay except as otherwise approved by City Council.

### 4.3 COMPENSATORY TIME

Non-exempt employees entitled to overtime pay may request compensatory time off instead of cash payment. This is approved on a case-by-case basis by the employee's department head. The City is not required to grant comp time instead of overtime pay. If the compensatory time option is exercised, the employee is credited with one and one-half times the hours worked as overtime. Maximum accrual of compensatory time shall be limited to two hundred forty (240) hours when combined with vacation (ex: vacation + comp time = 240 max). All compensatory time will be paid out in the year it is earned.

Employees may use compensatory time after getting approval from his/her department head. The use of comp time may be denied if such time used would disrupt City operations.

### 4.4 ATTENDANCE

Punctual and consistent attendance is a condition of employment. Each department head is responsible for maintaining an accurate attendance record of his/her employees.

Employees unable to work or unable to report to work on time should notify their supervisor as soon as possible, ordinarily before the work day begins or within thirty (30) minutes of the employee's usual starting time. If an absence continues beyond one day, the employee is responsible for reporting in each day. If the supervisor is unavailable, the employee may leave a message on the answering machine stating the reason for being late or unable to report for work.

An employee who is absent without authorization or notification is subject to disciplinary action, including possible termination.

### 4.5 UNUSUAL CONDITIONS

WEATHER During times of inclement weather or natural disaster, it is essential that the City continue to provide vital public services. Therefore, it is expected that employees make every reasonable effort to report to work without endangering their personal safety.

PANDEMIC During pandemic flu or other community health emergencies the City Administrator shall identify a set of procedures to be approved by Council to maintain essential city functions while protecting the health of the staff. Those procedures shall be tailored to the specific health emergency and could include but are not limited to staggered work schedules, working from home (remote computer connections), allowing



## City of Stevenson Personnel Policy

employees to use accrued leave or comp time, furloughing certain employees, and other appropriate actions.

### 4.6 BREAKS AND MEAL PERIODS

Employees may take one (1) fifteen-minute break for every four hours worked. All breaks shall be arranged so that they do not interfere with City business or service to the public. Meal periods shall be scheduled by the employee's supervisor. The scheduling of meal periods may vary depending on department workload. Meal periods are unpaid.

### 4.7 CALL BACK

All employees are subject to call back in emergencies or as needed by the City to provide necessary services to the public. A refusal to respond to a call back is grounds for immediate disciplinary action, including possible termination. An employee who is not fit to respond shall not accept a call back. Employees called back to duty will be paid their appropriate rate of pay for hours worked (the overtime rate for hours worked over the applicable overtime threshold).

### 4.8 PAYROLL RECORDS

The official payroll records are kept by the City Administrator. Each department head shall turn in, on a monthly basis, a signed work record for each employee within their department, noting hours worked, and leave taken and overtime worked. The Mayor shall sign work records for the City Administrator.



# City of Stevenson Personnel Policy

## CHAPTER 5: COMPENSATION

### 5.1 SALARY CLASSIFICATION AND GRADES

The City Administrator, Mayor and City Council shall be responsible for the preparation and maintenance of the City's position classifications for salary purposes. Each position classification is designated a particular salary or salary range as shown on the City's salary and wage schedule, which is approved annually by the City Council. The City Administrator shall, every five years, conduct comparative studies to ensure the salaries are competitive and justified and to ensure that the City's position classifications and compensation plan are properly connected. The most current salary schedule and job classifications will be filed in Appendix A-8.

The City's salary and wage schedule (the compensation plan) consists of a series of salary ranges. Within each range there are a series of steps graduated by standard percentage increments.

### 5.2 EMPLOYEE PAY RATES

Employees shall be paid within the limits of the wage range to which their positions are assigned. Usually, new employees will start their employment at the minimum wage rate for their classification. However, a new employee may be employed at a higher rate than the minimum when the employee's experience, training or proven capability warrant, or when prevailing market conditions require a starting rate greater than the minimum.

Pay increases are contingent on satisfactory performance. If an employee's performance is consistently unsatisfactory, the supervisor may defer a scheduled pay increase for a stipulated period of time or until the employee's job performance is satisfactory.

The Mayor may propose and the City Council may grant an across-the-board pay adjustment (COLA) from time to time, raising the salaries of all positions by a specified amount within a defined group of classifications. Such adjustments, if any, will not change an employee's pay anniversary date.

Any employee promoted to a position in a higher classification and salary range shall receive the next highest available pay step in the new range.

### 5.3 CERTIFICATION PAY

An incentive plan is established to provide a means for rewarding employees who assume additional certification beyond what is considered a normal part of their position. The plan shall further provide a means for rewarding such exemplary professional development of direct value to the city. Such reward shall be granted through a salary adjustment of 2% (two percent) for each certification, up to a maximum of 6% (six





## City of Stevenson Personnel Policy

percent). The adjustment shall be awarded after receipt of certification and is conditioned on the following:

- The employee must be at the top step of pay for at least one year.
- Only one certification can be added per year up to a max of three.
- Certifications will be reviewed on an annual basis.
- It is the responsibility of the employee to maintain and renew their certification.
- Any employee receiving a less than satisfactory Performance Review will not receive certification pay.

Examples of certifications include:

- Wastewater Treatment Plant Operator Group II
- American Institute of Certified Planner Certification
- American Public Works Association Certified Public Works Professional-Supervision
- American Public Works Association Certified Public Works Professional-Management
- Permit Technician Certification
- Certified Public Records Officer
- Certified Public Finance Officer
- Master Municipal Clerk
- International City/County Management Association Credentialed Manager
- Any other certification program approved by the Department Head and Mayor in alignment with city's goals and objectives.

An additional certification pay of 15% will be provided for a Professional Engineer and is not subject to the employee being at the top of their pay scale.

### 5.4 OUT OF CLASS PAY

“Out-of-class pay” means the temporary adjustment of an employee to perform most of the normal ongoing duties and responsibilities associated with a higher-paying job classification. The Director or City Administrator may temporarily assign the duties of higher-paying classification to an employee in order to continue or complete essential public services and compensate the employee for that performance. The threshold for granting an out-of-class assignment is when the employee who normally performs the duties will be away for 4 consecutive weeks or more. The temporary pay adjustment will increase the employee's regular base rate of pay to the greater of: 1) the Classification salary beginning rate of pay for the higher-level position or 2) ten percent above the Employee's regular base of pay.

### 5.5 ON CALL PAY

The City requires some employees to be “on-call” when needed to protect the health, safety and property of the City and its residents. To meet the needs of the City's utilities, employees with Water Plant Operator I and Wastewater Treatment Plant Operator I





## City of Stevenson Personnel Policy

certifications will be required to be “on call” on a rotating basis with other employees with these certifications. “On Call” requires that the employee will be available for all emergencies by an effective means, to be determined by each employee (telephone, cell phone, pager, radio, etc.). The employee must be able to respond to a call within 30 minutes and shall not be impaired at any time while on call. If the scheduled employee cannot fulfill their standby obligation, it is their responsibility to find an employee to take their place.

As compensation for “on call” coverage, “on call” pay will be paid to these employees on an hourly basis according to the Salary Key approved by City Council annually. It will be the responsibility of the Department Head to ensure that the stand-by days are equally shared among the responsible personnel.

### 5.4 PAYDAYS AND PAY PERIODS

City employees are paid monthly on the last business day of each month. If a regularly scheduled payday falls on Saturday or Sunday, pay will be distributed on Friday.

New monthly employees working less than a calendar month will be paid at a rate per hour determined by dividing the annual salary by 2080 hours for the actual day or hours worked. Permanent monthly employees after the probationary period is completed, who have used all accumulated sick leave and vacation leave will lose pay at a rate determined by dividing the annual salary by 2080 hours on the basis of eight hours for each day lost.

Part time employees shall be paid on an hourly basis. The hourly wage will be determined by dividing the annual salary by 2080 or will be set by contract in the case of contracted employees.

### 5.5 DEDUCTIONS

Some regular deductions from the employee’s earnings are required by law; other deductions are specifically authorized by the employee. The city will withhold from the employee’s paycheck those deductions required by law and any voluntary deductions authorized by the employee or by statute.

### 5.6 TRAVEL AND TRANSPORTATION REGULATIONS

Responsibilities: The Mayor, City Administrator or Director of Public Works are primarily responsible for ensuring that any cost incurred pursuant to this chapter are directly work related, ***obtained within the state rate***, and are both critical and necessary for city business. Prudent judgment is to be exercised in approving these costs. Receipts showing proof of payment will be required for all expense except for per diem meal reimbursements.



## City of Stevenson Personnel Policy

**Travelers:** A traveler on official city business is expected to exercise the same care in incurring expenses and accomplishing the purposes of the travel that a prudent person would exercise if traveling on personal business. Excess costs, circuitous routes, delays or luxury accommodations unnecessary or unjustified in the performance of official city business travel are not considered acceptable as exercising prudence. Travelers are responsible for excess cost and additional expenses incurred for personal preference or convenience.

**General:**

Travelers are to receive prior approval by the Mayor, City Administrator or Director of Public Works before embarking on any out of city travel for city business. Local travel within the Gorge and to the metropolitan area of Portland/Vancouver requires verbal permission of the appropriate Department Head. The City has established a set of guidelines for the handling of expenses while on city business:

**Mileage:** City owned vehicles should be used when traveling by automobile whenever possible for City business. If, however, there is reason to use a privately-owned automobile and the employee expects to be compensated for expenses (i.e., mileage allotment), prior approval must be obtained. In this case the rate of mileage reimbursement will be based on the standard mileage rate approved by the US Internal Revenue Service. The City Administrator will update the City's Travel Guide Sheet with the most current reimbursement rate on file with this policy. Each employee who drives a private vehicle on City business must have liability insurance on said vehicle. Carpooling is encouraged. Either state mileage charts or odometer readings can be used for calculating mileage reimbursement.

If public transportation is used, reimbursement shall not exceed the dollar amount of a round trip air fare at the coach rate on a licensed common carrier, plus auto rental or taxi fare at point of destination, and any associated parking fees.

**Lodging:** The reimbursement for lodging and associated travel expenses (such as parking fees) incurred on official city business in all areas of the Continental USA is to be on an actual expense basis for lodging and other travel expenses, as evidenced by a receipt, up to a specified maximum. Generally, the maximum for reimbursement for lodging expenses (before tax) shall not exceed the maximum allowable as stated in Schedule A or Schedule B of the State of Washington Policies, Travel and Transportation Regulations and Procedures Issued by the Office of Financial Management (as updated). The single rate should be clearly indicated on all receipts. If the employee is accompanied by another, it will be the employee's responsibility to pay the additional charges for the second person.

It is recognized that on certain occasions it will be necessary to exceed the adopted guidelines when an alternate reasonable accommodation is not available. This will require council approval with full documentation of the situation.



## City of Stevenson Personnel Policy

**Meals:** Meal reimbursements for all overnight trips incurred on official city business will be set on a per meal entitlement basis for subsistence (per diem). When the travel includes a partial day, the reimbursement will be prorated based on the time of travel. For example, a training in Vancouver requiring travel from 7am-5pm would include lunch whereas travel to a location from 3pm-8pm would include dinner, etc. The reimbursement amounts in both non-high cost and high cost areas of the USA shall not exceed the maximum allowable per diem rates stated in Schedule A or Schedule B, except as authorized by Subsection 4.2.7.2.2 of State of Washington Policies, Travel and Transportation Regulations and Procedures Issued by the Office of Financial Management. Annually, the City Administrator will update the City's Travel Guide Sheet with the most current reimbursement rate on file with this policy. It is recognized that it may be necessary on certain occasions (banquets at a conference) to exceed the above guidelines. Prior permission will be needed and receipts will be required. If a meal is included in the tuition or registration during a conference, training or other form of official city business, no meal reimbursement will be made if the employee opts to eat elsewhere. Breakfast compensation does not need to be reduced if continental breakfasts are provided with the lodging rate.

On occasion employees of the City must attend a seminar or conference as a City representative in the local area that will include a meal. A request for reimbursement for these meals must include date, place, meeting attended, and the specific reason for attendance. Receipts will be required.

### 5.7 COMPENSATION UPON TERMINATION

When an employee's employment with the City is terminated, the employee will receive the following compensation on the next regularly scheduled payday:

- (1) Regular wages for all hours worked up to the time of termination which has not already been paid.
- (2) Any overtime or holiday pay due.
- (3) A lump sum payment of any accrued but unused vacation and compensatory time.
- (4) Unused accumulated sick time will be compensated at the rate of 25% of the total remaining balance on retirement or separation after twenty-five years.



## City of Stevenson Personnel Policy

### CHAPTER 6: TRAINING & PERFORMANCE EVALUATIONS

#### 6.1 TRAINING

The City seeks, within the limits of available resources, to offer training to increase an employee's skill, knowledge and abilities directly related to City employment to obtain or maintain required licenses and certifications, and to develop staff resources. Opportunities may include, but are not limited to: on-the-job training, in-house workshops, and seminars sponsored by other agencies or organizations.

#### 6.2 PERFORMANCE EVALUATIONS

To achieve the City's goal to train, promote and retain the best qualified employee for every job, the City conducts periodic performance evaluations for all positions. The City Administrator is responsible for developing and maintaining the City's performance evaluation program. Employees are to be evaluated by their supervisor prior to completion of their trial period and usually once every year thereafter.



# City of Stevenson Personnel Policy

## CHAPTER 7: BENEFITS POLICY

### 7.1 RETIREMENT BENEFITS

The City makes contributions on behalf of all eligible employees to the Social Security System in addition to those contributions made by the employee through FICA payroll deductions.

All regular and part-time employees are covered under the Public Employees Retirement System (PERS). Benefit levels, membership qualifications and contribution rates are set by the State of Washington.

Employees intending to retire should notify their supervisor of their intent to retire at least three months prior to the date of retirement.

The City is a member of a deferred compensation plan which allows employees to make deferred deposits up to certain dollar limits defined by the IRS.

### 7.2 DISABILITY BENEFITS (WORKERS COMPENSATION)

When an employee is absent for one or more days due to an on-the-job accident, he/she is required to file a claim for Workers' Compensation. If the employee files a claim, the City will continue to pay (by use of the employee's unused sick leave) the employee's regular salary pending receipt of Workers' Compensation benefits.

Coordination of Benefits: When the employee receives Workers Compensation benefits, he/she is required to repay to the City the amount covered by Workers' Compensation and previously advanced by the City. This policy is to ensure that employees will receive prompt and regular payment during periods of injury or disability so long as accrued sick leave is available, while ensuring that no employee receives more than he/she would have received had the injury not occurred. Upon the repayment of funds advanced, the appropriate amount of sick leave shall be restored to the employee's account.

The City may require an examination at its expense, performed by a physician of its choice to determine when the employee can return to work and if he/she will be capable of performing the duties of the position.

### 7.3 HEALTH INSURANCE BENEFITS

Regular full-time employees, their spouses (including Domestic Partners as defined by City policy) and their dependents are eligible to participate in the City's various insurance programs on the first day of the month following employment. The programs and criteria for eligibility will be explained upon hire. The City contributes toward the cost of premiums in the amounts authorized by the City Council. The remainder of the premiums, if any, shall be paid by the employee through payroll deduction. For the purposes of medical insurance, the term dependent child includes children below the age



## City of Stevenson Personnel Policy

of 23; for children 23 to 26 the employee may choose to pay for coverage through the City's medical program. The City reserves the right to make changes in the carriers and provisions of these programs when deemed necessary or advisable, with prior notice to affected employees.

Part time employees may participate in the City's various insurance programs. Part time employees will contribute toward the cost of premiums based on a pro rata system established by the City Council for each position.

Employees may opt for pay in lieu of their medical benefits provided they have medical coverage through other means (spouse, domestic partner, Veteran's benefits, etc).

Temporary employees will normally not be eligible for insurance coverage.

Both retired and disabled employees shall have access to health insurance after leaving employment with the City. Eligible participants wanting to continue participation in the health plan will be responsible to pay the full cost of the medical coverage.

The City offers a Health Reimbursement Arrangement (HRA) benefit. The terms of the HRA are governed by the HRA VEBA policy as adopted by council.

### 7.4 CONTINUATION OF INSURANCE COVERAGE

Workers Compensation Leave: An employee receiving Workers Compensation benefits continues to accrue vacation leave and sick leave for up to six (6) months. The City also continues to pay for the employer's portion of health insurance premiums, provided that the employee continues to pay their share of premiums, if any. After six (6) months, the employee's benefits shall cease unless the Mayor or City Administrator makes an exception in individual situations pursuant to Section 1.4 criteria of these policies. The employee may continue health care benefits by self-paying insurance premiums for the remainder of the time he/she receives Workers Compensation benefits.

COBRA Rights: Upon an employee's termination from City employment or upon an unpaid leave of absence, at the employer's option and expense, the employee may be eligible to continue City health insurance benefits to the extent provided under the federal COBRA regulations. An administrative handling fee over and above the cost of the insurance premium may be charged to the employee or his/her dependents who elect to exercise their COBRA continuation rights.

Termination, Retirement, Leave of Absence: For eligible employees who terminate, retire or are on an approved leave of absence, the City will pay the premium for the month the employee is leaving if the employee works less than 80 hours in the month. If the employee works more than 80 hours in the month of termination, the City will pay the premium for the month following their departure.



## City of Stevenson Personnel Policy

### 7.5 UNEMPLOYMENT COMPENSATION

City employees may qualify for State Unemployment Compensation after termination from City employment depending on the reason for termination and if certain qualifications are met.

### 7.6 FIRE/EMERGENCY CALLS

Regular full-time city employees that also serve as Volunteer Firefighters may need to respond to emergency calls during working hours. It is the policy of the city to pay the employee for the entire day worked as if the emergency call had not occurred. If an employee needs to work additional hours to complete their job outside of their regular schedule due to an emergency call, the city will not pay overtime unless the total hours worked exclusive of the emergency would trigger overtime pay. For example, if an employee responded to a call that lasted one hour and worked three hours over their scheduled shift, they would be compensated for two hours of overtime.

Temporary city employees may respond to the emergency call but will not be compensated for the time away from their position.

### 7.7 BOOT ALLOWANCE

Regular full-time, non-probationary city employees working in the Public Works department will receive an annual \$200 boot reimbursement allowance. The city will comply with all IRS regulations regarding taxable fringe benefits and reimbursements.



# City of Stevenson Personnel Policy

## CHAPTER 8: LEAVES

### 8.1 VACATION LEAVE

Each regular full-time employee is entitled to vacation leave as follows:

<u>Years of Employment</u>	<u>Vacation Hours Earned</u>
0- 5 years	8 hours/month
6 years +	add 8 hours per year but not to exceed 240 hours per year.

All new employees must satisfactorily complete their 6-month trial period to be entitled to the accrual and use of vacation leave. (After satisfactorily completing the probation period, the 48 hours will be accrued.) Regular part-time employees will receive vacation on a pro-rata basis. Temporary employees are not eligible for any vacation benefits. Employees do not accrue vacation benefits during a leave without pay.

Each department is responsible for scheduling its employees' vacations without undue disruption of department operations. All requests for vacation must be approved by the department head and leave requests should be submitted at least two weeks prior to taking vacation leave. In the event of a conflict, the department head's decision will be guided by "first in" and seniority.

240 is the maximum number of vacation hours which may be accumulated. In cases where City operations have made it impractical for an employee to use vacation time, the department head with the approval of the Mayor may authorize additional carryover and/or a buyout. Minimally the employee must use or have a plan to use 80 hours of vacation within a full year of employment and the employee must have a minimum of eighty (80) hours remaining in the leave bank. Cash out will be at the rate of pay in effect on the date of the cash out payment. Vacation leave compensation may be part of the negotiations for employment for exempt employees. Employees will be paid for unused vacation time upon termination of employment.

### 8.2 SICK LEAVE

All full-time regular employees accrue sick leave benefits at the rate of 8 hours for each calendar month of continuous employment. Regular part-time employees may accrue sick leave benefits on a pro-rata basis according to hours worked, with a minimum rate of 1 hour for every 40 hours worked. Sick leave compensation may be part of the negotiations for employment for exempt employees. Temporary employees will accrue sick leave benefits at the rate of 1 hour for every 40 hours worked. Employees do not accrue sick leave benefits during a leave without pay. Such leave shall be accumulated up to a maximum of 1,440 hours.





## City of Stevenson Personnel Policy

Allowable uses of Sick Leave: Sick leave covers those situations in which an employee is absent from work due to:

1. Employee's own health condition (illness, injury, physical or mental disability, including disability due to pregnancy or childbirth);
2. The need to care for the employee's dependent children under the age of 18 who are ill.
3. To care for a spouse, child, parent, parent-in-law, or grandparent with a health condition requiring treatment or supervision, or for emergency purposes.
4. Medical or dental appointments for the employee or dependent child, provided that the employee must make a reasonable effort to schedule such appointments at times which have the least interference with the work day.
5. Exposure to a contagious disease where on the job presence of the employee would jeopardize the health of others;
6. Use of a prescription drug which impairs job performance or safety;
7. Additional leave beyond bereavement leave for a death in the immediate family, to be authorized by the Mayor.
8. When the employees' workplace or their child's school or place of care has been closed by a public official for any health-related reason.
9. For absences that qualify for leave under the state's Domestic Violence Leave Act.

A doctor's certificate may be required when an employee is absent for a period in excess of 3 days. The City may also request the opinion of a second doctor at the City's expense to determine whether the employee suffers from a chronic physical or mental condition which impairs his/her ability to perform the job. Employees who are habitually absent due to illness or disability may be terminated if their disability cannot be reasonably accommodated and/or when the employee's absenteeism prevents the orderly and efficient provision of services to the citizens of the City.

Employees who use all their accumulated sick leave and require more time off work due to illness or injury may, with their department head's approval, request a leave without pay. (See Leave Without Pay Policy.)

Employees will be paid for unused sick leave as stipulated in section 5.7 Compensation upon termination.

### 8.3 LEAVE WITHOUT PAY

The Mayor or City Administrator may grant leaves of absence without pay for absence from work not covered by any other type of leave or if other leave balances are exhausted. Examples of situations for which leave without pay may be granted include time off work for personal reason, such as a prolonged illness, parenting, caring for an ill relative, or pursuing an education.



## City of Stevenson Personnel Policy

### 8.4 JURY AND WITNESS LEAVE

It is the civic obligation of each employee to serve on a jury if he is called. While on jury duty or while appearing as a legally required witness, an employee will receive full pay from the city but the city shall deduct or the employee shall sign over the amount equal to jury fees actually received by the employee.

### 8.5 ADMINISTRATIVE LEAVE

On a case-by-case basis, the City may place an employee on administrative leave with or without pay for an indefinite period of time. Administrative leave may be used in the best interests of the City (as determined by the Mayor) during the pendency of an investigation or other administrative proceeding.

### 8.6 MILITARY LEAVE

The City provides all employees leave while performing military service in accordance with federal and state law. Regular full-time and part-time employees receive paid military leave of up to 15 working days per year for military service. In general, if military service extends beyond 15 working days, the additional leave will be unpaid. Exempt salaried employees who serve longer than two weeks should contact the City Administrator to discuss whether further paid leave will be provided. All employees who are not eligible for paid military leave are provided unpaid leave for a period of their military service. Military service includes active military duty and Reserve or National Guard training. You are required to provide your supervisor with copies of your military orders as soon as possible after they are received. Reinstatement upon return from military service will be determined in accordance the applicable federal and state law. Health insurance will be paid for the first 30 days of active duty and Cobra-like benefit will be available to continue insurance coverage beyond the 30-day period.

During a period of military conflict as defined by SB 6447 an employee who is the spouse of a member of the armed forces of the United States, national guard, or reserves who has been notified of an impending call or order to active duty is entitled to a total of fifteen days of unpaid leave per deployment as described in SB 6447.

### 8.7 FAMILY LEAVE

The City complies with the federal Family and medical Leave Act of 1993 (the FMLA) and all applicable state laws related to family and medical leave. This means that, in cases where the law grants you more leave than our leave policies provide, we will give you the leave required by law.

**Family Leave Eligibility:** The FMLA provides up to 12 weeks of unpaid, job-protected leave every 12 months to eligible male and female employees for certain family and



## City of Stevenson Personnel Policy

medical reasons. To be eligible you must have worked for us for at least one year, and for 1,250 hours over the previous 12 months.

Reasons for Taking Leave: Unpaid FMLA leave is granted for any of the following reasons:

- To care for your child after birth or placement for adoption or foster case.
- To care for your spouse, son, daughter or parent who has a serious health condition.
- For a serious health condition that makes you unable to perform the essential functions of your job.
- To care for a spouse, child, parent, or next of kin injured in the line of duty as a member of the Armed Forces and who is undergoing medical treatment, recuperation, or therapy for serious injury or illness incurred in the line of active duty for up to a total of 26 weeks (12 weeks as outlined above plus an additional 14 weeks) of protected leave within a 12-month period.
- To address a “qualifying exigency” arising out of the employee’s spouse, child, or parent in the Armed Forces serving on active duty.

Leave to care for a child after birth or placement for adoption or foster care must be concluded within 12 months of the birth or placement.

Under some circumstances, FMLA leave may be taken intermittently – which means taking leave in blocks of time, or by reducing your normal weekly or daily work schedule. FMLA leave may be taken intermittently if medically necessary because of a serious health condition. FMLA leave may be taken by victims of domestic violence, sexual assault or stalking to take “reasonable” or intermittent leave from work to obtain legal or law enforcement assistance, medical treatment or counseling. If FMLA leave is for birth or placement for adoption or foster care, use of intermittent leave is subject to our approval.

Substitution of Paid Leave: At your request or ours, certain kinds of paid leave may be substituted for unpaid FMLA leave. Accrued vacation may be substituted for any type of FMLA leave. Accrued sick leave may be substituted only in the circumstances where our policies or state law allow you to use that paid leave. This means, in general, that sick leave may be used only for leave taken because of your own health condition or a spouse, child, parent, parent-in-law, or grandparent with a health condition requiring treatment or supervision, or for emergency purposes.

If you have any sick leave available that may be used for the kind of FMLA leave you are taking, it is our policy that you must use that paid sick leave as part of your FMLA leave. Use of vacation time for FMLA leave, however, is at your option.

If you use paid leave for a purpose for which FMLA leave would be available, it is our policy to designate your paid leave as counting against your FMLA leave allowance.



## City of Stevenson Personnel Policy

You are required to notify us if you use paid leave for a reason covered by the FMLA so that we may properly account for the leave.

Advance Notice and Medical Certifications: We require that you provide us with advance leave notice, with medical certification, of the need for a leave related to a health condition, and with medical certification of your fitness to return to duty after medical leave. Taking leave, or reinstatement after leave, may be denied if these requirements are not met.

You must give us at least 30 days' advance notice of your request for leave if the reason for the leave is foreseeable based on an expected birth, placement for adoption or foster care, or planned medical treatment. If 30 days' notice is not practicable, you must give us notice as soon as practicable, usually within one or two business days of when the need for leave becomes known to you. If you do not give us 30 days' advance notice, and if the need for the leave and the approximate date of the leave were clearly foreseeable by you, we may deny your request for leave until at least 30 days after the date you give us notice.

We require that you provide a medical certification to support a request for leave because of a serious health condition (your own or your child's, spouse's or parent's) whenever the leave is expected to extend beyond five consecutive working days or will involve intermittent or part-time leave. We may require second or third opinions, at our option, at our expense.

We require that you provide a medical certification of your fitness for duty to return to work after a medical leave that extends beyond 10 consecutive working days, that involves a mental disability or substance abuse, or where the medical condition and your job are such that we believe you may present a serious risk of injury to yourself or others if you are not fit to return to work.

Periodic Reporting: If you take leave for more than two weeks, we require that you report to us at least every two weeks on your status and intent to return to work.

Health Insurance: If you are covered by our group health plan (medical, dental or vision), we will continue to provide paid health insurance during FMLA leave on the same basis as during regular employment. But if you don't return to work after the leave, you will be required to pay us back for our portion of the insurance premiums unless your failure to return was beyond your control.

Other Insurance: If you are covered by other insurance plans through us, such as life or disability insurance, those coverages will continue during paid leave on the same basis as during regular employment. If you take unpaid FMLA leave, you will be responsible during the leave for the premiums you normally pay plus the premiums we normally pay for you. If you don't pay these premiums, we may choose to pay them for you, to keep your coverage from lapsing, but you will be responsible for repaying us whether or not you return to work.



## City of Stevenson Personnel Policy

Couples Employed by Us: If both you and your spouse work for us and you request leave for the birth, adoption or foster care placement of a child, to care for a new child, or to care for a sick parent, the total annual FMLA leave available to you as a couple for those purposes is 12 weeks.

Determining Leave Availability: FMLA leave is available for up to 12 weeks during a 12-month period. For purposes of calculating leave availability, the “12-month” period is a rolling 12-month period measured backwards from the date you use any FMLA leave.

Leave Related to Pregnancy: If you take leave for the disability phase of pregnancy or childbirth while you are physically unable to work, this time is counted against your annual 12-week FMLA leave allowance. For example, if you take six weeks of FMLA leave for childbirth to recover from childbirth, you are entitled to only six weeks of FMLA leave after that to care for your new child.

You are entitled to unpaid leave for the full period of your physical disability resulting from pregnancy and childbirth, even if you are disabled for more than 12 weeks, and even if you don’t qualify for leave under the federal law.

### 8.8 BEREAVEMENT LEAVE

We provide regular, full-time and part-time employees with paid leave for up to three (3) days in the event of the death of an immediate family member. An immediate family member is defined as parent, child, grandparent, grandchild, sibling, spouse or significant other.

### 8.9 SHARED LEAVE PROGRAM

The Mayor or Administrator may authorize employees to donate their accrued vacation or sick leave to another City employee who is suffering from or who has an immediate family member suffering from an extraordinary or severe illness, injury, or physical or mental condition which has caused or is likely to cause the employee to take leave without pay or to terminate his/her employment. The following conditions apply:

- To be eligible to donate vacation or sick leave, the employee who donates leave must have at least ten days of accrued leave. In no event shall a leave transfer result in the donor employee reducing his/her vacation or sick leave balance to less than ten days. Transfer of leave will be in increments of one day of leave. All donations of leave are strictly voluntary.
- The employee receiving donated leave shall have exhausted all his/her accumulated vacation and sick leave.
- While an employee is using shared leave, he or she will continue to receive the same treatment, in respect to salary and benefits, as the employee would otherwise receive if using vacation or sick leave.



# City of Stevenson Personnel Policy

## 8.10 HOLIDAYS

The following are recognized as paid holidays for all regular full-time and part-time employees:

New Year’s Day	January 1
MLK Day	3 <sup>rd</sup> Monday in January
President’s Day	3 <sup>rd</sup> Monday in February
Memorial Day	Last Monday in May
Juneteenth	June 19
Independence Day	July 4
Labor Day	1 <sup>st</sup> Monday in September
Veteran’s Day	November 11
Thanksgiving	4 <sup>th</sup> Thursday in November
Day after Thanksgiving	Day after Thanksgiving
Christmas Day	December 25
Personal Day (16 hrs)	Optional

Any holiday falling on Saturday will be celebrated on the preceding Friday. Any holiday falling on Sunday will be celebrated on the following Monday.

In their first year of employment, newly hired employees with a start date prior to July 1<sup>st</sup> will receive 2 Personal Days, while those with a start date of July 1<sup>st</sup> or later will receive 1 Personal Day.

Non-exempt regular full-time or part-time employees will be paid for the holiday plus 2½ times their regular rate of pay for any time worked on the holiday. Such time must be pre-authorized by the department head. An employee substituting paid sick/vacation for unpaid FMLA leave is entitled to any holiday pay that would be normally paid.

Temporary employees will be paid at their regular straight-time rate for hours worked on a holiday.

## 8.11 RELIGIOUS HOLIDAYS

If an employee’s religious beliefs require observance of a holiday not included in the basic holiday schedule, the employee may, with his/her departments head’s approval, take the day off using vacation, compensatory time, floating holiday or leave without pay.

## 8.12 BENEFITS FOR PART-TIME AND TEMPORARY EMPLOYEES

Unless noted otherwise in these policies, benefits for regular part-time and temporary employees are as follows:



## City of Stevenson Personnel Policy

Regular Part-Time Employees: All leaves, including holidays, and insurance premiums are pro-rated. Pro-rated means the ratio between the number of hours in the employee's normal work schedule and 40 hours per week.

Temporary Employees: Temporary employees are not eligible to receive benefits, including leaves other than Sick Leave, holidays and insurance.



# City of Stevenson Personnel Policy

## CHAPTER 9: EMPLOYEE RESPONSIBILITIES & CONDUCT

### 9.1 GENERAL CODE OF CONDUCT

It shall be the responsibility of all employees to represent the City to the public in a manner which shall be courteous, efficient, and helpful.

The City is a relatively small organization. To function as efficiently as possible, we may ask you to perform seemingly “menial” duties outside your regular assignments. It is no reflection on your worth to the City but a necessary arrangement for most small organizations.

To make the most efficient use of personnel, the City also reserves the right to change your work conditions and the duties originally assigned. If these arrangements become necessary, we expect your best cooperation.

### 9.2 OUTSIDE EMPLOYMENT AND CONFLICTS OF INTEREST

The City of Stevenson allows its employees to engage in outside work subject to certain restriction. Employees are required to disclose outside work, other jobs, contractual commitments or self-employment to their department head and obtain prior approval to perform outside work or hold another job.

Employees shall not, directly or indirectly, engage in any outside employment or financial interest which may conflict, in the City’s opinion, with the best interests of the City or interfere with the employee’s ability to perform his/her assigned City job. Outside work will not be considered an excuse for poor job performance, absenteeism, tardiness, leaving early, refusal to travel, or refusal to work overtime or different hours.

### 9.3 CODE OF CONDUCT

From time to time employees will be asked to participate in the selection, award or administration of a contract supported by federal and/or state grant funds. The employee shall NOT participate in the selection, award or administration of the contract if there is a conflict of interest, real or apparent, such as:

- The employee, elected official, or agent;
- Any member of his/her immediate family;
- His/her partner; or
- An organization that employs, or is about to employ any of the above, has a financial or other interest in the firm selected for award.

Furthermore, the employee shall not solicit nor accept gratuities, favors, or anything of monetary value from contractors, potential contractors, or subcontractors.





## City of Stevenson Personnel Policy

### 9.4 REPORTING IMPROPER GOVERNMENTAL ACTION

In compliance with the Local Government Employee Whistleblower Protection Act, RCW 42.41.050, this policy is created to encourage employees to disclose any improper governmental action taken by City Officials or employees without fear of retaliation. This policy also safeguards legitimate employer interests by encouraging complaints to be made first to the City, with a process provided for speedy dispute resolution. (See Appendix #A-5, A-6)

### 9.5 POLITICAL ACTIVITIES

City employees may participate in political or partisan activities of their choosing provided that City resources and property are not utilized, and the activity does not adversely affect the responsibilities of the employees in their positions. Employees may not campaign on City time or in a City uniform or while representing the City in any way. Employees may not allow others to use City facilities or funds for political activities. No person may solicit on City property for contributions to be used for political subdivisions.

Any City employee who meets with or may be observed by the public or otherwise represents the City to the public, while performing his/her regular duties, may not wear or display any button, badge or sticker relevant to any candidate or ballot issue during working hours. Employees shall not solicit, on City property or City time, for a contribution for a partisan political cause. Except as noted in this policy, City employees are otherwise free to fully exercise their constitutional First Amendment rights.

For persons employed by the City in positions which are financed primarily by federal grant-in-aid funds, political activity will be regulated by the rules and regulations of the United States Civil Service Commission.

### 9.6 NO SMOKING POLICY

For health and safety considerations, the City prohibits smoking by employees in all City facilities, including City owned buildings, vehicles, and offices or other facilities rented or leased by the City, including individual employee offices.

### 9.7 PERSONAL POSSESSIONS AND ELECTRONIC COMMUNICATIONS

The City furnishes desks, closets, and/or lockers for security of employee coats, purses, and other personal possessions. We do not, however, assume responsibility for any theft or damage to the personal belongings of employees, and we reserve the right to search employee desks, lockers, and personal belongings brought onto City premises, if necessary.



## City of Stevenson Personnel Policy

The City also furnishes computers for use in conducting City business. Because the computers are for City business, the City reserves the right to review the contents of any files or documents on the computer including contents of any electronic mail. City Department heads may and will intermittently monitor internet usage. Receipt of a public records request for public employees' internet usage places all internet usage subject of public disclosure without prior consent or notice. City computers are not for personal use. See appendix A-4 for policy, procedures and agreements regarding Cell Phones and A-9 for policy, procedures and agreement regarding Internet.

### 9.8 USE OF CITY VEHICLES AND EQUIPMENT

Use of City phones for personal phone calls should be kept to a minimum. Other City equipment, including vehicles, should be used by employees for City business only. An employees' misuse of City services, telephones, vehicles, equipment or supplies can result in disciplinary action including termination.

It is important to clarify the use of City vehicles to better interpret City policy and maintain community confidence in the wise use of city resources. City vehicles may not be used for personal use including personal errands such as banking, shopping and etc. City-owned vehicles/equipment are restricted to City business and are for employee use only. Children or individuals not engaged in a direct City business activity are not permitted. Any driver of a City vehicle will not consume alcohol or illegal drugs while conducting City business.

City vehicles may be used to attend business functions, for out of town travel, and to travel between the job site and lunch or break sites when working in the field. There is a group of employees who are required to drive motorized vehicles in the performance of their jobs and who have been assigned first responder responsibilities. These activities require emergency duties. For those City staff that are assigned stand-by duty, City vehicle use may be authorized for commuting between the place of residence and place of work both for regular work hours and after work hour periods.

### 9.9 USE OF CITY CREDIT CARDS (Ref. Resolution No. 132)

Gas Credit Cards – An employee whose job responsibilities would be facilitated by the use of a credit card will be assigned a gas credit card to be used in the day to day operations of his/her department. Cash Advances, purchases of food or other non-automotive related items are not authorized.

Other Credit Cards – Other credit cards may be used by City employees for advanced payment of expenses associated with authorized travel such as registration and tuition fees, lodging expenses and transportation expenses. The credit cards may also be used for official government purchases and acquisitions, including supplies, small tools and equipment. Credit cards shall not be used for cash advances. The employee is expected to submit a fully itemized expense voucher for the charges. The employee will be responsible for repayment for disallowed charges.



## City of Stevenson Personnel Policy

### 9.10 CONTACT WITH THE NEWS MEDIA

The City Administrator shall designate the person to be responsible for official contacts with the news media during working hours, including answering of questions from the media. The City Administrator may designate specific employees to give out procedural, factual or historical information on particular subjects.

### 9.11 DRIVER'S LICENSE REQUIREMENTS

As part of the requirements for certain specific City positions, an employee may be required to hold a valid driver's license with the appropriate endorsements. If an employee's license is revoked, suspended or lost, or is in any other way not current, valid, and in the employee's possession, the employee shall promptly notify his/her supervisor and will be immediately suspended from driving duties. The employee may not resume driving until proof of a valid, current license is provided to his/her supervisor. Depending on the duration and the employee's duties, the license suspension, revocation or other inability to drive, an employee may be subject to disciplinary action, including termination. The City may review the driving record of any employee whose job requires them to drive City vehicles at least annually. The driving record will be evaluated according to the matrix in appendix A-14 and a determination Borderline or Poor may lead to a loss of driving duties and consequences as outlined above. It is the responsibility of the employee to inform his/her supervisor if a physical condition or medical treatment might impair their driving ability.

### 9.12 SOLICITATIONS

Most forms of selling and solicitations are inappropriate in the workplace. They can be an intrusion on employees and citizens and may present a risk to employee safety or to the security of City or employee property. The following limitations apply:

1. Persons not employed by us may not solicit, survey, petition, or distribute literature on our premises at any time. This includes persons soliciting for charities, salespersons, questionnaire surveyors, labor union organizers, or any other solicitor or distributor.
2. Employees may not solicit for any purpose during work time. Reasonable forms of solicitation are permitted during non-work time, such as before or after work or during meal or break periods. Soliciting employees who are on non-work time may not solicit other employees who are on work time. Employees may not distribute literature for any purpose during work time or in work areas. The employee lunchroom is considered a non-work area under this policy.



## City of Stevenson Personnel Policy

### 9.13 SAFETY

The City Administrator recognizes the need for the development of safe working conditions and practices for every employee and desires to promote on-the-job safety by encouraging the proper design and use of buildings, equipment, tools, and other design and use of buildings, equipment, tools, and other devices. Responsibility for development, promotion and coordination of the safety program throughout the various City departments shall be a primary function of the supervisors of each department.

Administration of the adopted safety program is the responsibility of supervisors. Supervisors and employees should be constantly on the alert to observe and report unsafe working practices or existing hazardous working conditions with the aim of immediate correction. Each supervisor shall insure that the employees under his supervision are well acquainted with existing safety rules and shall make certain that the rules are uniformly enforced. Each employee will be personally responsible for keeping informed and being constantly aware of all the latest State Industrial Safety guidelines and Safety Policies as they are presented and/or approved by the City. Safety education of all employees shall be promoted by supervisors adhering to all safety rules. Any employee who habitually or purposely ignores or fails to comply with established safety rules, as outlined by the State Industrial agency or the City, will be subject to suspension, without pay, or dismissal as deemed necessary by the supervisor.

### 9.14 DRUG-FREE WORKPLACE

The City will strive to educate and increase employee awareness of the dangers of drug abuse in the workplace, the City's commitment to maintaining a drug-free workplace, the penalties that may be imposed upon employees for drug violations in the workplace, and the City's commitment of support for employees undergoing treatment and rehabilitation for chemical dependencies.

The City recognizes maintenance of a drug-free workplace as essential to the safety and welfare of its employees and the public. This policy establishes programs and practices that promote and support a drug-free working environment and brings the City into compliance with the Drug-Free Workplace Act of 1988.

- The manufacture, distribution, dispensation, possession and use of unlawful drugs or alcohol on City premises or during work hours by City employees are strictly prohibited.
- The use of prescription and over-the-counter drugs which compromise safety in the workplace or the quality of the employee's work product is prohibited. It is the employee's responsibility to check with his/her physician as to whether or not a prescription or over-the-counter drug will impair performance and to notify his/her supervisor of the physician's opinion.



## City of Stevenson Personnel Policy

- As a condition of employment, all employees must notify their supervisor of any criminal drug statute conviction for a violation occurring in the workplace no later than five days after such a conviction.

Violation of this policy can result in immediate disciplinary action, up to and including termination. The employee may be required to participate satisfactorily in an alcohol or drug abuse assistance or rehabilitation program.

The City will utilize available City resources, including drug education programs to educate employees about the dangers of drug abuse.

All complaints and reported violations for these policy provisions will be strictly confidential, except as required by public disclosure laws or court order.

### 9.15 DRUG & ALCOHOL TESTING POLICY & PROCEDURES

The City of Stevenson provides vital public services to our community. In an effort to ensure that services are delivered safely and efficiently, we are intent on providing and maintaining a drug and alcohol-free working environment. It is the City of Stevenson's policy to:

- Create a workplace free from the adverse effects of drugs and alcohol abuse or misuse;
- Assure that all employees have the ability to perform assigned duties in a safe, healthy and productive manner.
- Comply with all regulations applicable to City employees under the federal Omnibus Transportation Employee Testing Act of 1991, 49 CFR Part 40, as amended, 49 CFR Part 382, as amended, RCW 46.25, as amended and the Drug Free Workplace Act of 1988. Copies of 49 CFR Parts 382 and 40 can be found on the Internet at the Department of Transportation (DOT) Office of Drug and Alcohol Policy and Compliance website <http://www.transportation.gov/odapc>. A copy of RCW 46.25 may be found on the Internet at the Washington State Legislature Uniform Commercial Driver's License Act Website <https://app.leg.wa.gov/RCW/default.aspx?cite=46.25>.

### DEFINITIONS

Covered Employee: An employee that performs safety-sensitive functions.

Safety-sensitive functions:

- Driving a commercial motor vehicle which requires the driver to have a CDL:
  - (1) Has a gross combination weight rating or gross combination weight of 11,794 kilograms or more (26,001 pounds or more), whichever is greater, inclusive of a towed unit(s) with a gross vehicle weight rating or gross vehicle weight of more than 4,536 kilograms (10,000 pounds), whichever is greater; or



## City of Stevenson Personnel Policy

- (2) Has a gross vehicle weight rating or gross vehicle weight of 11,794 or more kilograms (26,001 or more pounds), whichever is greater; or
- (3) Is designed to transport 16 or more passengers, including the driver; or
- (4) Is of any size and is used in the transportation of materials found to be hazardous for the purposes of the Hazardous Materials Transportation Act (49 U.S.C. 5103(b)) and which require the motor vehicle to be placarded under the Hazardous Materials Regulations (49 CFR part 172, subpart F).

- Waiting to be dispatched to operate a commercial motor vehicle
- Inspecting, servicing, or conditioning any commercial motor vehicle
- Performing all other functions in or upon a commercial motor vehicle (except resting in a sleeper berth)
- Loading or unloading a commercial motor vehicle, supervising or assisting in the loading or unloading, attending a vehicle being loaded or unloading, remaining in readiness to operate the vehicle, or giving or receiving receipts for shipments being loaded or unloaded
- Repairing, obtaining assistance, or remaining in attendance upon a disabled vehicle

### SCOPE

This policy outlines the City's position relative to alcohol and drug control in the workplace and applies to all employees at all levels of the City of Stevenson. The City will not tolerate use of this policy to harass or intimidate employees.

- The following policy has been adopted not only to protect the health and safety of all employees, but to encourage any employee with a drug or alcohol dependence problem to help him/herself by voluntarily seeking professional assistance. The City is committed to helping employees deal with any drug or alcohol abuse problem they may have.
- The City recognizes that each employee has a desire to maintain a degree of privacy and that this desire should be respected. The City believes that the provision of this policy, in conjunction with its general commitment to helping individuals with a drug or alcohol dependency problem, creates a balance between the interest of the City and the rights and needs of its employees.
- The City will assist any employee, who voluntarily seeks help for a drug or alcohol abuse problem, in initial intervention and referral. Employees who voluntarily seek assistance for an alcohol or drug related problem before it becomes a subject of formal discipline will not be subject to disciplinary action. Rehabilitation, however, is the responsibility of the employee.
- Employees shall be subject to random testing for the purpose of discovering possible drug or alcohol abuse and as mandated by state or federal law.

### PROHIBITED BEHAVIOR

All employees are prohibited from behavior which is outlined in the City of Stevenson's Drug Free Workplace Policies and Procedures. Federal regulation (Title 49, CFR subtitle





## City of Stevenson Personnel Policy

B, Chapter III, part 382 subpart B) prescribes prohibited behavior for employees subject to those regulations. Prohibited behavior includes:

- Alcohol concentration: Reporting for duty or remaining on duty while having a blood alcohol concentration of 0.04 or greater
- Alcohol Possession: Possession of alcohol while on duty or operating a commercial motor vehicle.
- On Duty Use of Alcohol: Use of alcohol while on duty. (This includes alcohol that may be in medications.)
- Pre-duty Use of Alcohol: Performance by an on-call employee of safety sensitive functions within four hours after using alcohol. If called out, pre-duty use of alcohol must be discussed with supervisor. If the on-call employee claims the ability to perform his or her safety-sensitive function, he or she must take an alcohol test with a result of less than 0.02 prior to performance. All employees are prohibited from consuming alcohol within four (4) hours prior to the performance of safety-sensitive job functions.
- Use Following Accident: Use of alcohol within eight hours following an accident or before undergoing a post-accident alcohol test, whichever occurs first.
- Use of Controlled Substances (Drugs): Reporting for duty or remaining on duty after having used any controlled substance, except when the use is pursuant to the instructions of a physician who has advised that the substance does not adversely affect the employee's ability to safely perform their duties.
- Use of Illegal Drugs: Use of illegal drugs is prohibited at all times. All employees are prohibited from reporting for duty or remaining on duty any time there is a quantifiable presence of a prohibited drug in the body at or above the minimum thresholds defined in 49 CFR Par 40. Prohibited drugs include:
  - Marijuana
  - Cocaine
  - Phencyclidine (PCP)
  - Opioids
  - Amphetamines
- Refusal to Submit to a Required Test: Refusing to submit to a post-accident, random, reasonable suspicion, or follow-up alcohol or controlled substances test as directed pursuant to this policy.
- Positive Drug Test: Reporting for duty, or remaining on duty, after having tested positive for a controlled substance.

City supervisors and managers shall not permit employees to remain on duty when they engage in any of the above prohibited behavior.

### PRESCRIPTION DRUG USE

The appropriate use of legally prescribed drugs and non-prescription medications is not prohibited. However, the use of any substance which carries a warning label that indicates that mental functioning, motor skills, or judgment may be adversely affected



## City of Stevenson Personnel Policy

must be reported to the immediate supervisor. Medical advice should be sought, as appropriate, while taking such medication and before performing safety-sensitive duties.

Regardless of State Laws on recreational and medical marijuana use, marijuana (THC) is a schedule I prohibited substance as defined by the United States Drug Enforcement Agency and is a banned substance under this policy. A positive marijuana test is a violation of this policy. A violation of this policy shall result in disciplinary action that may include termination.

### PROCEDURES

- All employees who are required to have a valid Commercial Driver's License (CDL) must be tested for the presence of controlled substances and alcohol as a condition of employment in accordance with these regulations and randomly on an ongoing basis.
- All employees may be subject to testing prior to employment in permanent full-time positions, for reasonable suspicion, and prior to return after failing a test or upon the completion of substance abuse treatment.
- All City employees who have a permanent, full-time status may be subject to testing following an on-duty incident or accident if there is reasonable suspicion of impairment.
- City employees may be requested to undergo a drug screen test if the City has reasonable suspicion that an employee is under the influence of alcohol or a controlled substance. "Reasonable suspicion" shall mean that articulable facts or information exists which appears reliable and discloses facts or circumstances which, when taken together, would convince an ordinary, reasonable person that the suspected person is under the influence of a controlled substance. Test results gathered under this policy will not be used in a criminal investigation or prosecution.
- Following an accident in a City owned vehicle the employee(s) involved must immediately submit to an alcohol or drug screen test if such test is required by the supervisor. The test must be taken within 8 hours following the accident or incident, if the employee's performance either contributed to the accident, or cannot be discounted as a contributing factor. The term "accident" is defined as an incident involving City owned vehicles which resulted in damages amounting to at least \$1,000.00.
- No alcohol or drug test shall be conducted without the consent of the employee, but refusal by the employee to submit to a drug screen test will be deemed an admission of violation of this policy, thus subjecting the employee to the risk of discipline, including termination.
- Any employee who tests positive for drugs or alcohol (BAC at or above 0.04) or refuses to test (as defined by 49 CFR Part 40) will be immediately removed from safety-sensitive duty and referred to a Substance Abuse Professional (SAP) in accordance with 49 CFR Part 40, Part 382 and RCW 46.25, et.al. **A violation of**





## City of Stevenson Personnel Policy

**this policy will result in disciplinary action, up to and including termination of employment, at the company's discretion.**

- Following a BAC of 0.02 or greater, but less than 0.04, the employee will be immediately removed from safety-sensitive duties until the start of the employee's next regularly scheduled duty period, but not less than 24 hours following administration of the test.
- The City may request that a specific employee submit to a search of his/her person or possessions if the City has probable cause that the employee has any drugs and/or alcohol concealed in a particular place on City property.
- A medical Review Officer (MRO) shall be utilized to review and interpret positive test results. The MRO must examine alternate medical explanations for any confirmed positive test result. This action may include conducting a medical interview with the addicted employee, review of the employee's medical history and review of any other relevant biomedical factors. The MRO must review all medical records made available by the tested employee when a confirmed positive test could have resulted from legally prescribed medication.
- The City recognizes that a flexible approach will be necessary in handling violations of this policy. As a result, the measures taken in response to a particular violation will depend on a number of factors including the nature of the violation, the risks to health and safety created by the violation, the employee's willingness to take steps toward rehabilitation and the employee's length of service and employment record. **All employees should be aware that any violation, by any employee, may result in termination of employment.**
- Employees who violate this policy may be subject to progressive discipline. Normally, a first offense will result in requirement that the employee successfully complete a course of rehabilitation if such course is suggested by a counselor. An employee may be suspended during such rehabilitation depending on the facts of each case. Upon completion of a course of rehabilitation following a first offense, the employee will sign an agreement (form attached), agreeing to submit to random testing at the City's expense and on City time during the six calendar months following the employees return to work. During this period, failure to submit to the appropriate drug screen test will result in immediate termination. However, if there are mitigating circumstances and the employee has 2 yrs. of service with the City and a work record which is otherwise good, a second rehabilitation may be attempted. A third violation will result in immediate termination. See [Appendix A-1](#) for agreement.
- Related records will be maintained by the employer as prescribed in the City's Records Retention Guidelines and file.

### CIRCUMSTANCES FOR TESTING

#### *Pre-Employment Testing*

A negative pre-employment drug test result is required before an employee can first perform safety-sensitive functions (as defined by 49 CFR Part 40). If a pre-employment test is cancelled, the individual will be required to undergo another test and successfully pass with a verified negative result before performing safety-sensitive functions.



## City of Stevenson Personnel Policy

If a covered employee has not performed a safety-sensitive function for 30 or more consecutive calendar days and has not been in the random testing pool during that time, the employee must take and pass a pre-employment test before he or she can return to a safety-sensitive function.

A covered employee or applicant who has previously failed or refused a DOT pre-employment drug and/or alcohol test must provide proof of having successfully completed a referral, evaluation, and treatment plan meeting DOT requirements. **If the employee has a Washington State issued Driver's License, they must provide proof of reinstatement of that CDL endorsement.**

### *FMCSA Drug Testing Exceptions*

A driver is not required to undergo a pre-employment test if:

- (1) The driver has participated in a DOT testing program within the previous 30 days; and
- (2) While participating in that program, either:
  - (i) Was drug tested within the past six months (from the date of application with the City), or
  - (ii) Participated in the random drug testing program for the previous 12 months (from the date of application with the City); and
- (3) The City can ensure that no prior employer of the driver of whom the City has knowledge has records of a violation of this part or the controlled substances use rule of another DOT agency within the previous six months.

### *Reasonable Suspicion Testing*

All employees shall be subject to a drug and/or alcohol test when the City has reasonable suspicion to believe that the employee has used a prohibited drug and/or engaged in alcohol misuse. A reasonable suspicion referral for testing will be made by a trained supervisor or other trained company official on the basis of specific, contemporaneous, articulable observations concerning the appearance, behavior, speech, or body odors of the employee (See Appendix A-11).

Employees may be subject to reasonable suspicion drug testing any time while on duty. Employees may be subject to reasonable suspicion alcohol testing while the employee is performing safety-sensitive functions, just before the employee is to perform safety-sensitive functions, or just after the employee has ceased performing such functions.

### *Post-Accident Testing*

#### DOT FMCSA Procedures

Covered employees shall be subject to FMCSA post-accident drug and alcohol testing under the following circumstances (Also, see Appendix A-12):

#### Fatal Accidents



## City of Stevenson Personnel Policy

As soon as practicable following an occurrence involving a commercial motor vehicle operating on a public road in commerce, and involving the loss of a human life, drug and alcohol tests will be conducted on each surviving covered employee who was performing safety-sensitive functions with respect to the vehicle.

### Non-fatal Accidents

As soon as practicable following an occurrence involving a commercial motor vehicle operating on a public road in commerce, and not involving the loss of a human life, an alcohol test will be conducted on each driver who receives a citation within eight (8) hours of the occurrence under State or local law for a moving traffic violation arising from the accident, if:

- (1) The accident results in injuries requiring immediate medical treatment away from the scene; or
- (2) One or more motor vehicles incur disabling damage and must be transported away from the scene by a tow truck or other motor vehicle.

As soon as practicable following an occurrence involving a commercial motor vehicle operating on a public road in commerce, and not involving the loss of a human life, a drug test will be conducted on each driver who receives a citation within thirty-two (32) hours of the occurrence under State or local law for a moving traffic violation arising from the accident, if:

- (1) The accident results in injuries requiring immediate medical treatment away from the scene; or
- (2) One or more motor vehicles incur disabling damage and must be transported away from the scene by a tow truck or other motor vehicle.

A covered employee subject to post-accident testing must remain readily available, or it is considered a refusal to test. Nothing in this section shall be construed to require the delay of necessary medical attention for the injured following an accident or to prohibit a covered employee from leaving the scene of an accident for the period necessary to obtain assistance in responding to the accident or to obtain necessary emergency medical care.

### *Random Testing*

Random drug and alcohol tests are unannounced and unpredictable, and the dates for administering random tests are spread reasonably throughout the calendar year. Random testing will be conducted at all times of the day when safety-sensitive functions are performed.

Testing rates will meet or exceed the minimum annual percentage rate set each year by DOT FMCSA. The current year testing rates can be viewed online at <http://www.transportation.gov/odapc/random-testing-rates>. If a given driver is subject to random testing under the rules of more than one DOT agency, the driver will be subject



## City of Stevenson Personnel Policy

to random drug and alcohol testing at the annual percentage rate established by the DOT agency regulating more than 50% of the driver's function.

The selection of employees for random drug and alcohol testing will be made by a scientifically valid method, such as a random number table or a computer-based random number generator. Under the selection process used, each covered employee will have an equal chance of being tested each time selections are made.

A covered employee may only be randomly tested for alcohol misuse while the employee is performing safety-sensitive functions, just before the employee is to perform safety-sensitive functions, or just after the employee has ceased performing such functions. A covered employee may be randomly tested for prohibited drug use anytime while on duty.

Each covered employee who is notified of selection for random drug or random alcohol testing must immediately proceed to the designated testing site.

### *Return to Duty Testing*

Any employee who is allowed to return to safety-sensitive duty after failing or refusing to submit to a drug and/or alcohol test must first be evaluated by a substance abuse professional (SAP), complete a SAP-required program of education and/or treatment, and provide a negative return-to-duty drug and/or alcohol test result. All tests will be conducted in accordance with 49 CFR Part 40, Subpart O.

### *Follow-up Testing*

Employees returning to safety-sensitive duty following leave for substance abuse rehabilitation will be required to undergo unannounced follow-up alcohol and/or drug testing for a period of one (1) to five (5) years, as directed by the SAP. The duration of testing will be extended to account for any subsequent leaves of absence, as necessary. The type (drug and/or alcohol), number, and frequency of such follow-up testing shall be directed by the SAP. All testing will be conducted in accordance with 49 CFR Part 40, Subpart O.

### *Testing Procedures*

All DOT FMCSA drug and alcohol testing will be conducted in accordance with 49 CFR Part 40, as amended.

### *Dilute Urine Specimen*

**If there is a negative dilute test result, the City will conduct one additional retest.** The result of the second test will be the test of record.

Dilute negative results with a creatinine level greater than or equal to 2 mg/dL but less than or equal to 5 mg/dL will require an immediate recollection (as indicated on the MRO result letter). The re-collection will be conducted under direct observation as required under 49 CFR Part 40.



## City of Stevenson Personnel Policy

### *Split Specimen Test*

In the event of a verified positive test result, or a verified adulterated or substituted result, the employee (and only the employee) can request to the MRO that the split specimen be tested at a second laboratory. The City guarantees that the split specimen test will be conducted in a timely fashion.

### *Test Refusals*

As a covered employee, you have refused to test if you:

- (1) Fail to appear for any test (except a pre-employment test) within a reasonable time, as determined by the City.
- (2) Fail to remain at the testing site until the testing process is complete. An employee who leaves the testing site before the testing process commences for a pre-employment test has not refused to test.
- (3) Fail to attempt to provide a breath or urine specimen. An employee who does not provide a urine or breath specimen because he or she has left the testing site before the testing process commenced for a pre-employment test has not refused to test.
- (4) In the case of a directly-observed or monitored urine drug collection, fail to permit monitoring or observation of your provision of a specimen.
- (5) Fail to provide a sufficient quantity of urine or breath without a valid medical explanation.
- (6) Fail or decline to take a second test as directed by the collector or the City for drug testing.
- (7) Fail to undergo a medical evaluation as required by the MRO or the City's Designated Employer Representative (DER).
- (8) Fail to cooperate with any part of the testing process.
- (9) Fail to follow an observer's instructions to raise and lower clothing and turn around during a directly-observed test.
- (10) Possess or wear a prosthetic or other device used to tamper with the collection process.
- (11) Admit to the adulteration or substitution of a specimen to the collector or MRO.
- (12) Refuse to sign the certification at Step 2 of the Alcohol Testing Form (ATF).
- (13) Fail to remain readily available following an accident.

As a covered employee, if the MRO reports that you have a verified adulterated or substituted test result, you have refused to take a drug test.

As a covered employee, if you refuse to take a drug and/or alcohol test, you incur the same consequences as testing positive and will be immediately removed from performing safety-sensitive functions, and referred to a SAP. **A violation of this policy shall result in disciplinary action that may include termination.**

### DOT-FMCSA CLEARINGHOUSE

The Clearinghouse is a centralized database that employers will use to report drug and alcohol program violations and to check that current or prospective employees are not



## City of Stevenson Personnel Policy

prohibited from performing safety-sensitive functions, such as operating a commercial motor vehicle (CMV), due to an unresolved drug and alcohol program violation—that is, a violation for which the driver has not completed the return-to-duty (RTD) process. This query must be conducted as part of a pre-employment driver investigation, and at least annually for current employees. The driver’s commercial driver’s license (CDL) number and issuing State will be used when reporting a drug and alcohol program violation in the Clearinghouse.

The Clearinghouse will contain records of violations of drug and alcohol prohibitions in 49 CFR Part 382, Subpart B, including positive drug or alcohol test results and test refusals. When a driver completes the return-to-duty (RTD) process and follow-up testing plan, this information will also be recorded in the Clearinghouse.

Drivers are not required to register for the Clearinghouse. However, a driver will need to be registered to provide electronic consent in the Clearinghouse if a prospective or current employer needs to conduct a full query of the driver’s record. A driver must also be registered to electronically view the information in his or her own Clearinghouse record. Any covered employee refusing to provide consent (See Appendix A-13) for the company to conduct a limited query of the Clearinghouse will be prohibited from performing safety-sensitive functions, including driving a commercial motor vehicle (CMV), as required by FMCSA drug and alcohol program regulations.

### TRAINING

- The City will ensure that all employees will receive material explaining the City’s policy on alcohol and drug use and misuse.
- All supervisors must receive training on alcohol misuse and drug abuse within the first year of employment with the City. Training must address skills needed to determine “reasonable suspicion”.

### CONFIDENTIALITY

Confidentiality is to be maintained throughout the drug/alcohol testing process. All positive test results shall be first forwarded to a Medical Review officer (MRO) for review. The MRO shall review the individual medical history and afford the employee an opportunity to offer any clarifying information that would explain the positive test. The City will maintain results in the strictest of confidence in a medical file separate from the official personnel file. In cases where disciplinary action results from a positive test, such information shall be shared only with those in a supervisory capacity involved in that action. The City of Stevenson will carry out this policy in a manner which respects the dignity and confidentiality of those involved.

### VOLUNTARY SELF-REFERRAL

Any employee who has a drug and/or alcohol abuse problem and has not been selected for reasonable suspicion, random or post-accident testing or has not refused a drug or



## City of Stevenson Personnel Policy

alcohol test may voluntarily refer her or himself to the City Administrator, who will refer the individual to a substance abuse counselor for evaluation and treatment. **A self-referral is not a violation of this policy and will not, in itself, be grounds for termination.**

The substance abuse counselor will evaluate the employee and make a specific recommendation regarding the appropriate treatment. Employees are encouraged to voluntarily seek professional substance abuse assistance before any substance use or dependence affects job performance.

Any safety-sensitive employee who admits to a drug and/or alcohol problem will immediately be removed from his/her safety-sensitive function until successful completion of a prescribed rehabilitation program. Prior to participating in a safety-sensitive function, the employee must also undergo a DOT return-to-duty drug test with a verified negative result and/or a return-to-duty alcohol test with a result indicating an alcohol concentration of less than 0.02.





## City of Stevenson Personnel Policy

### CHAPTER 10: DISCIPLINE & TERMINATIONS

#### 10.1 ACTIONS SUBJECT TO DISCIPLINARY ACTION

Our success in providing excellent service to our citizens and maintaining good relationships with the community depends on our employees. We have therefore provided for your guidance certain conduct which, if engaged in, would be detrimental to our objective and could lead to disciplinary action including discharge. The following specified conduct is illustrative and not comprehensive.

1. Misrepresentation or withholding of pertinent facts in securing employment.
2. Unauthorized use or possession of the City facilities/property.
3. Unauthorized use of position with the City for personal gain or advantage.
4. Accepting unlawful gratuities or bribes.
5. Lying.
6. Smoking in any unauthorized posted area or creating fire hazards in any area.
7. Violation of the City's telephone use policy.
8. Failure to report an occurrence causing damage to City, customer, or public property.
9. Failure to properly secure the City facilities or property.
10. Loitering after completing day's work which results in the disruption of the City's business or the work effort of other employees.
11. Vending, soliciting, or collecting contributions for any purpose whatsoever during working time on the premises without the permission of the supervisor.
12. Unauthorized operation or using machines, tools, or equipment to which the employee has not been specifically assigned.
13. Unauthorized recording of another employee's time record. Both employees can be subject to disciplinary action.
14. Habitual lateness for work.
15. Absence without prior notification to immediate supervisor, excessive absenteeism, or insufficient reasons for absenteeism.
16. Loitering, goofing off, failing to assist others in a work situation.
17. Making malicious, false, or derogatory statements that are intended or could reasonably be expected to damage the integrity or reputation of the city or our employees, on or off premises.
18. Disorderly conduct, including fighting on the premises.
19. Rudeness, discrimination, intimidation, coercion, use of obscene language, gesture or lack of courtesy to the public or fellow employees.
20. Immoral conduct while on duty.
21. Intentional falsification of records/paperwork required in the transaction of the City business.
22. Inability, inefficiency, negligence, or insubordination, including a refusal or failure to perform assigned work.
23. Concealing defective work.
24. Failure to observe safety practices, rules, regulations, and instructions.





## City of Stevenson Personnel Policy

25. Negligence that results in injury to others.
26. Failure to wear required safety clothing and equipment.
27. Failure to promptly report to your immediate supervisor an on-the-job injury or accident involving an employee, equipment, property, or visitor.
28. Failure to obtain necessary certifications.
29. Dishonesty or theft, including deliberate destruction, damage, or removal of the city's or other's property from the premises, or any job site.
30. Possession, use, sale, or being under the influence of alcohol and controlled substances while on the city business (including standby duty). The only exception to this rule shall be for an employee using or possessing a controlled substance prescribed by a doctor if such employee has given his/her supervisor prior notice of such use and/or efficient work performance.
31. Possession of explosives or weapons on the premises or at any job site.
32. Conviction of a gross misdemeanor or felony.

### 10.2 POSSIBLE DISCIPLINARY ACTIONS

In the event that discipline is necessary, the following types of disciplinary actions may be used, depending on the particular situation:

1. Oral Warning.
2. Written Reprimand.
3. Suspension
4. Demotion.
5. Termination.

Progressive discipline is the preferred alternative when appropriate. This system gives the employee an opportunity to correct problems. The choice of what discipline to apply in any particular case is solely the City's. Employees who are exempt from overtime laws will not be suspended without pay for disciplinary purposes for periods less than a full workweek, unless the infraction involves violation of safety rules of major significance. Serious misconduct may result in immediate discharge of any employee.

Employees shall comply with all existing rules that are not in conflict with the express terms of this policy, provided that reasonable notice has been given of the existence of the rule. Any unresolved complaint as to the reasonableness of any new or existing rule, or any complaint involving discrimination in the application of new or existing rules shall be resolved through the complaint procedure. The City will make a good faith effort to enforce rules uniformly. (Supervisors reference [Appendix A-2](#) for guidelines.)

### 10.3 PRE-TERMINATION HEARING

In the case of termination or demotion of an employee (other than trial employees), the city will conduct a pre-termination or pre-demotion hearing. The pre-termination or pre-demotion hearing serves as a check against mistaken decisions and as an opportunity for an employee to furnish additional facts before a termination or demotion decision is



## City of Stevenson Personnel Policy

finalized. Thorough investigation is critical to comply with all constitutional safeguards and rules of just cause.

In the event a supervisor desires to terminate an employee, the employee shall be provided with a written notice of the recommendation for termination. The notice shall include an explanation for the charges on which the recommendation is based, and the time, place and date for a pre-termination hearing. If the employee fails or refuses to appear, the termination may proceed.

Pre-termination hearings will be presided over by the Mayor or a designated representative. The hearings are intended to be informal. The employee may show cause why he/she should not be terminated. The employee may bring one person to the hearing as a representative.

Usually within two (2) working days after the pre-termination hearing, the Mayor will issue a decision on whether there are reasonable grounds to believe the charges against the employee are true and support termination. A longer review period may be required in more complex situations.

### 10.4 LAYOFF

The Mayor may lay off employees for lack of work, budgetary restrictions, reorganization or other changes that have taken place.

Temporary employees or employees who have not completed their trial period will be laid off before regular employees are affected. In determining who is to be laid off, consideration will usually be given to individual performance and the qualifications required for remaining jobs. Seniority will be considered when performance and qualifications are equal, as determined by the City. Employees who are laid off may be eligible to be re-employed, if a vacancy occurs in a position for which they are qualified.

### 10.5 RESIGNATION OR RETIREMENT

An employee should provide at least 2 weeks written notice of resignation or retirement. This time limit may be waived by the employee's supervisor or the Mayor. A Separation Agreement will be signed upon departure from City employment ([Appendix A-3](#)).



## City of Stevenson Personnel Policy

# CHAPTER 11: COMPLAINT PROCEDURES

## 11.1 COMPLAINT PROCEDURES

The City recognizes that sometimes situations arise in which employees feel that they have not been treated fairly or in accordance with City policies. The complaint could be a dispute or misunderstanding between the employee and his/her direct supervisor concerning the application or interpretation of specific provisions of this policy. For this reason, the City provides its employees with procedures for resolving complaints. Use of this procedure will not reflect unfavorably on the employee or the employee's immediate supervisor.

Step 1: Employees should first try to resolve any problem or complaint with their supervisor.

Step 2: If the employee is not satisfied with the response from the supervisor, the employee may submit the problem, in writing, to the Mayor or City Administrator. The written complaint must contain, at a minimum:

1. A description of the problem, identifying the facts and identity of involved parties;
2. A specific policy or procedure which the employee believes has been violated or misapplied;
3. The date of the circumstances leading to the complaint or the date when the employee first became aware of those circumstances;
4. The remedy sought by the employee to resolve the complaint.
5. The date the written complaint was submitted.

The written complaint must be filed within 10 working days of the occurrence leading to the complaint, or 10 working days after the employee becomes aware of the circumstances.

As a part of the inquiry or investigation, the Mayor or City Administrator may meet with the parties, either individually or together to compile the facts necessary to reach a decision. The Mayor or City Administrator will usually respond in writing to the aggrieved employee within ten working days of the meeting. The Mayor's or City Administrator's response and decision shall be final and binding.

Under no circumstances shall an employee have the right to utilize both this process and any other complaint or appeal procedure that may be available to an employee.



# City of Stevenson Personnel Policy

## Appendix # A-1

**CONFIDENTIAL \*\*\*\*\*CONFIDENTIAL\*\*\*\*\*CONFIDENTIAL**

### MEMORANDUM OF AGREEMENT

This agreement is between the CITY OF STEVENSON and (employee) \_\_\_\_\_.

As a result of access to the City’s Employee Assistance Program Services, and upon the recommendation of the assistance provider, the employee in this agreement is being returned to work on (date) \_\_\_\_\_.

Return to work and continued employment with the City is based upon the following voluntary agreement between the City and \_\_\_\_\_ (hereafter referred to as the Employee).

During the six calendar months immediately following the employee’s return to work date, the employee agrees to submit to random testing at the City’s expense.

Failure or refusal of the employee to comply with a City request to submit to a drug test as agreed to in this document will be grounds for immediate termination from employment.

Any positive test of the employee during the period outlined above will be grounds for immediate termination from employment or as outlined in Section 9 of the Policy.

I have read and understand this document and voluntarily agree to comply and abide with its provisions.

Signed: \_\_\_\_\_ Date: \_\_\_\_\_



# City of Stevenson Personnel Policy

## Appendix # A-2

### SUPERVISOR GUIDES

To ensure consistency, supervisors should be familiar with the City's workplace expectations before issuing any discipline. If there are any questions, consult with the City Administrator and/or Mayor. Suspensions, demotions and terminations can only be determined by the City Administrator and/or Mayor.

#### Oral Warnings

- Talk to the employee in private.
- Oral warnings are appropriate for relatively minor infractions where the employee will have an opportunity to correct the condition.
- Supervisor should file a written, dated notation that an oral warning was given with a reference to subject matter.

#### Written Reprimand

- Supervisor should issue a written reprimand when an employee has disregarded an oral warning or if the infraction severity warrants a written reprimand.
- The supervisor should describe in writing the nature of the infraction in detail and the supervisor should sign and date the reprimand.
- Prior to meeting with the employee, the supervisor should discuss the warning notice with his/her supervisor.
- The supervisor should then meet with the employee to be certain the employee understands the nature of the reprimand. The employee should receive a copy.
- The written reprimand should be filed with the employee's personnel file.

#### Suspension

- This form of discipline is administered as a result of a severe infraction or for excessive violations after a written reprimand. Suspension should not be considered without first discussing the issues with the Administrator and /or Mayor.
- The supervisor shall set forth in writing all facts for the reason for the Notice of Suspension and the duration of the suspension. A copy will be filed with the employee's personnel file and given to the employee.
- The supervisor should demonstrate that a thorough investigation is completed with both sides of the facts being objectively investigated.
- The supervisor shall meet with the employee and give the employee an opportunity to respond. If major issues are raised, the City may investigate further before confirming intent.

#### Demotion

- This form of discipline is rare – used in instances when an employee has been promoted to a position to which they are unable to perform the responsibility or in instances when a City is reducing its force and laying staff off.
- See terminations.

#### Terminations

- Prior to a supervisor taking any actions on discharge of an employee, the supervisor must discuss his/her recommendation for discharge with the Administrator and/or Mayor.
- A thorough investigation is critical. All facts should be reviewed objectively. Review the personnel file to determine if there is a pattern of behavior. Get witness statements.
- Review the issues for justification of the discharge. Follow rules of just cause. Were all procedural protections applied?
- If paid suspension is needed to complete an investigation, use it.
- Document.
- Provide the employee a hearing where the employee will have an opportunity to explain before final action.
- Follow Loudermill guidelines.



# City of Stevenson Personnel Policy

## Appendix # A-3

### SEPARATION AGREEMENT (a)

This separation agreement (hereinafter referred to as "Agreement") is made effective \_\_\_\_\_, 20\_\_, by and between the City of Stevenson and \_\_\_\_\_ (hereinafter referred to as the "Employee").

For and in consideration of the mutual covenants herein contained, the City of Stevenson and Employee agree as follows:

1. EMPLOYEE will separate active employment with the City of Stevenson effective \_\_\_\_\_, 20\_\_.
2. The City of Stevenson will pay EMPLOYEE a total severance benefit of \$ \_\_\_\_\_, less required deductions upon the signing of this Agreement, equal to \_\_\_\_\_ month(s) of salary continuation. This severance payment will be payable over the three-month period, on the City of Stevenson's regularly scheduled pay periods. This payment is in lieu of all accrued salary, and benefits and continuation of EMPLOYEE'S salary, benefits, and any other matters to which EMPLOYEE might otherwise be entitled. EMPLOYER further agrees to provide EMPLOYEE with continued medical, dental and vision benefits under its current policies so long as EMPLOYEE is eligible under federal COBRA laws. If EMPLOYEE makes timely application for these COBRA benefits, EMPLOYER will pay the premium for these benefits, less any deduction for dependent coverage, for the period of salary continuation. After this period, for the remaining portion of the CORA benefits, EMPLOYEE will pay the premiums.
3. EMPLOYEE agrees that this severance benefit is not a benefit that he/she would otherwise be entitled to under existing employee benefit plans provided by the City of Stevenson. The severance payment will be made irrespective of whether EMPLOYEE accepts other employment or dies, and is subject to the usual federal income tax, social security, and any other applicable withholdings.
4. EMPLOYEE accepts the benefits specified herein in full payment and satisfaction of all his/her rights and interest relating to his/her employment with the City of Stevenson its affiliates, owners, directors, stockholders, agents, employees, and successors and assigns, from any and all claims, demands, and causes of action, which he/she now has or any manner arise out of his/her employment with, or separation from, the City of Stevenson. This release specifically covers, but is not limited to, any and all claims EMPLOYEE may have under federal, state, and local laws that prohibit discrimination in employment, any contract or tort claims arising under federal, state, or local law, and any claims under any express or implied contract or legal restriction on the City of Stevenson's rights to deal with employees. EMPLOYEE hereby covenants not to assert any such claims or causes of action.
5. EMPLOYEE represents that he/she has not filed any complaints, charges or lawsuits against the City of Stevenson with any governmental agency or any court, and that he/she will not do so at any time hereafter.
6. EMPLOYEE represents that he/she has read, considered, and fully understands this Agreement, and all its terms, and executes it freely and voluntarily.
7. EMPLOYEE acknowledges that he/she has had the opportunity to consult with his/her attorney prior to accepting this Agreement, and has had an adequate opportunity to do so.
8. EMPLOYEE agrees to maintain the confidentiality of this Agreement. EMPLOYEE agrees not to divulge the terms of this Agreement to, or discuss the events leading up to his/her separation from the City of Stevenson with, any person other than his/her attorney and members of his/her immediate family.
9. EMPLOYEE represents that in entering into this Agreement, he/she does not rely and has not relied upon any representation or statement made by the City of Stevenson or any of its employees or agents concerning this Agreement or Employee's separation from employment with the City of Stevenson.
10. It is understood and agreed that by entering into this Agreement, the City of Stevenson expressly denies that it has any legal liability in this matter. This Agreement is solely intended as the resolution of a disputed claim and may not be used by anyone as an admission of any kind by the City of Stevenson.
11. This Agreement is intended to constitute a full and final resolution of this matter. Interpretation of this Agreement shall be under Washington law. If any such action is necessary to enforce the terms of this Agreement, the substantially prevailing party shall be entitled to receive reasonable attorney's fees and costs.

\_\_\_\_\_  
EMPLOYEE

\_\_\_\_\_  
Date

\_\_\_\_\_  
THE CITY OF STEVENSON

\_\_\_\_\_  
Mayor

\_\_\_\_\_  
Date





# City of Stevenson Personnel Policy

## SEPARATION AGREEMENT (b)

This separation agreement (“Separation Agreement”) by and between the City of Stevenson and \_\_\_\_\_ (“Employee”).

For good and valuable consideration, the parties agree as follows:

1. Separation of Employment. EMPLOYEE’S last date of employment with the City of Stevenson shall be \_\_\_\_\_, 20\_\_\_\_.
2. Severance Pay. The City of Stevenson agrees to pay EMPLOYEE \_\_\_\_\_ weeks of severance pay at his/her current regular rate of pay. Such severance pay shall be paid by check in a lump sum payment; provided, however, that the severance payment shall not be made until after EMPLOYEE has returned the executed Separation Agreement to the City of Stevenson, and the Revocation Period specified in Paragraph 8 below has expired. The severance payment made under this Separation Agreement shall be subject to all withholdings required by state and federal law. The parties agree that the separation pay described in this Paragraph 2 is designed to aid EMPLOYEE’s transition to alternative employment, and that the specified benefits do not constitute benefits to which she would otherwise be entitled upon separation under existing employee benefit plans provided by the City of Stevenson or under any pre-existing benefit plans provided by the EMPLOYEE and the City of Stevenson.
3. Health Insurance. If EMPLOYEE makes timely application and remains eligible for such benefits, the City of Stevenson will provide EMPLOYEE and his/her dependents with continued medical, dental and vision benefits under its current health insurance policies for 18 months following the Separation Date (“COBRA” benefits). It is the intent of the parties that EMPLOYEE’s COBRA rights begin to run on the Separation Date.
4. Accrued Vacation and Floating Holidays. The City of Stevenson agrees to pay EMPLOYEE for vacation and floating holidays that he/she has accrued but not used, if any, as of the Separation Date.
5. Release. EMPLOYEE accepts the benefits contained in this Separation Agreement in full satisfaction of all his/her rights and interests relating to his/her employment with and separation from the City of Stevenson and, in consideration therefore, EMPLOYEE hereby releases the City of Stevenson, its affiliates, successors, predecessors, past and present officers, directors agents, and employees from all claims (other than claims for the payments provided for under this Separation Agreement), causes of action or liabilities, suspected or unsuspected and irrespective of any present lack of knowledge of any possible claim or of any fact or circumstance pertaining thereto, which EMPLOYEE may have or claim to have against the City of Stevenson arising from or during his/her employment or as a result of his/her separation from employment. This release specifically covers, but is not limited to, any workers’ compensation or disability claims under state law; any claims of discrimination based on race, color, national origin, sex, marital status, age (including claims under the Age Discrimination in Employment Act) or physical or mental disability under any federal, state, or local law, rule, or regulation; any contract or tort claims arising under federal, state, or local law; any claims arising under federal, state or local law based on promises made or allegedly made by the City of Stevenson to EMPLOYEE; and any claims under any express or implied contract or legal restrictions on the City of Stevenson’s right to terminate its employee. EMPLOYEE hereby covenants not to assert any such claims or causes of action.
6. Other Claims or Lawsuits. EMPLOYEE represents that as of the date she executes this Separation Agreement, she has not filed any complaints, charges or lawsuits against the City of Stevenson with any governmental agency or any court.
7. No Admission. Nothing in this Separation Agreement shall be construed as any indication that the City of Stevenson has acted wrongfully towards EMPLOYEE or any other person.
8. Review and Revocation. EMPLOYEE acknowledges that:
  - a. Pursuant to applicable law, she has been offered the opportunity to review a copy of this Separation Agreement for a period of twenty-one (21) days (the “Review Period”).
  - b. The City of Stevenson advised EMPLOYEE at the beginning of the Review Period to consult with an attorney concerning the terms and conditions of this Separation Agreement, including without limitation the release set forth in this Separation Agreement; and
  - c. The terms and conditions of this Separation Agreement have not been amended, modified, or revoked during the Review Period. The City of Stevenson and EMPLOYEE agree that EMPLOYEE shall have seven (7) calendar days (the “Revocation Period”) following the date on which EMPLOYEE signs this Separation Agreement to revoke his acceptance of the Separation Agreement and the release set forth in this Separation Agreement, and this Separation Agreement shall not become effective until the Revocation Period has expired.



# City of Stevenson Personnel Policy

9. Confidential Information. EMPLOYEE acknowledges that while employed by the City of Stevenson and its predecessor, she had access to certain confidential information relating to the business of the City of Stevenson and its predecessor which constitute trade secrets of the City of Stevenson under the Uniform Trade Secrets Act, RCW 19.108. EMPLOYEE acknowledges that under the Uniform Trade Secrets Act, she has an obligation to maintain the confidentiality of such trade secrets of the City of Stevenson.
10. Voluntary Execution. EMPLOYEE represents that she has read, considered, and fully understands this Separation Agreement and all its terms, and executes it freely and voluntarily.
11. Construction of Agreement; Governing Law. Each party has had a full and complete opportunity to review this Separation Agreement, and has been given the opportunity to have counsel review it. Accordingly, the parties agree that the common law principles of construing ambiguities against the drafter shall have no application to this Separation Agreement. Interpretation of this Separation Agreement shall be under Washington law. If any such action is necessary to enforce the terms of this Separation Agreement, the substantially prevailing party shall be entitled to receive reasonable attorneys' fees and costs.
12. No Representations. EMPLOYEE represents that in entering into this Separation Agreement, she does not relay and has not relied upon any representation or statement made by the City of Stevenson or any of its employees or agents concerning this Separation Agreement.
13. Confidentiality. EMPLOYEE Agrees to keep the terms of this Separation Agreement confidential, except for communications about it with his/her immediate family, attorney or accountants or other professional financial advisors.
14. Remedies for Breach of Covenants. In the event of a breach or threatened breach by EMPLOYEE of any covenants herein, EMPLOYEE agrees that the City of Stevenson shall be entitled to a temporary restraining order or a preliminary injunction (without the necessity of the City of Stevenson posting any bond in connection therewith) restraining EMPLOYEE from such breach or threatened breach. Nothing herein shall be construed as prohibiting the City of Stevenson from pursuing any other remedies available to it for such breach or threatened breach, including the recovery of damages from EMPLOYEE.
15. Complete Agreement. This Separation Agreement constitutes a full and final resolution of all matters in any way related to EMPLOYEE's employment with and separation from the City of Stevenson. This Separation Agreement supersedes any and all other agreements between the parties.
16. Amendment. The parties agree that no modification, change or amendment of this Separation Agreement or any of its provisions shall be valid, unless in writing and signed by the party against whom such claimed modification, change or amendment is sought to be enforced.
17. Severability. If any provision of this Separation Agreement, or portion thereof, shall be held invalid or unenforceable by a court of competent jurisdiction or in any arbitration proceeding, such invalidity or unenforceability shall attach only to such provision or portion thereof, and shall not in any way affect or render invalid or unenforceable any other provision of this Separation Agreement or portion thereof, and this Separation Agreement shall be carried out as if any such invalid or unenforceable provision or portion thereof were not contained herein. In addition, any such invalid or unenforceable provision shall be deemed, without further action on the part of the parties, modified, amended or limited to the extent necessary to render the same valid and enforceable.
18. Titles. The titles of the paragraphs of this Separation Agreement are inserted merely for convenience and ease of reference and shall not affect or modify the meaning of any of their terms, covenants or conditions of the Separation Agreement.

IN WITNESS WHEREOF, the parties have executed this Separation Agreement as their free and voluntary act on the dates set forth below.

\_\_\_\_\_  
EMPLOYEE

\_\_\_\_\_  
Date

THE CITY OF STEVENSON

\_\_\_\_\_  
Mayor

\_\_\_\_\_  
Date



# City of Stevenson Personnel Policy

## Appendix # A-4:

### CELL PHONE POLICY

#### PURPOSE

The purpose of this policy is to provide cell phone use guidelines. This policy enables the City of Stevenson to meet its fiduciary responsibility to the taxpayers. It is recognized that the day-to-day operations of the workforce require voice and data communications and there is often a need to communicate when access to a regular telephone or computer is unavailable. Cell phones are a valuable resource for certain personnel in order to conduct City business in an effective and timely manner.

#### DEFINITIONS

**Employee**—A person employed by the City, does not include an independent contractor.

**City Business**—Official City business is business that relates directly to a person's work function and benefits the City.

**Cell Phone**—Cellular telephones including smart phones: any device that is used, by any measure, to send or receive wireless voice or data transmissions including text messaging.

#### POLICY

This policy shall apply to all City employees.

1. The City recognizes that cell phones are an important and necessary tool for certain employees to perform their job duties. For this purpose, the City will provide a cell phone.
2. The City Administrator will determine which employees require a cell phone by considering the individual job duties and related wireless communications needs. The Purchasing Officer will procure the most cost-effective cell phone and plan. State contracts, pooling of minutes, and free phone offers are examples of the methods that will be used to establish the most cost-effective alternative for cell phones and plans.
3. The use of a cell phone, whether owned by the employee or the City, creates data that is stored on the devices, including, without limitation, e-mails, text messages, communication logs (such as records of the numbers called and received). When the cell phone is used for City business that record is, in nearly every case, a public record, subject to possible disclosure under the Public Records Act. It is the employee's responsibility to ensure that all cell phone data related to City business is retained consistent with this policy and all City rules, regulations, policies and procedures.
4. All communications created or received using a City cell phone and all data stored on the devices is the property of the City. Employees have no personal or property right



## City of Stevenson Personnel Policy

in these communications and data and no expectation of privacy with regard to their use of City communication devices. Furthermore, the City reserves the right to access and monitor any and all communications created or received using a City-owned cell phone, any record of such communications and all data stored on City cell phones, including, without limitation, e-mails, text messages, communication logs (such as records of the numbers called and received) to ensure that all use of a City cell phone is consistent with this policy and all City rules, regulations, policies and procedures.

### PROCEDURE

#### 1. Determination of Cell Phone Eligibility

- a. Eligibility is based on the need for frequent use of a cell phone, such as an employee who needs to be frequently available for emergency contact, and whose duties require him/her to be quickly contacted, anywhere, anytime as determined by the City Administrator.
- b. Employees leaving City employment must turn in City-owned cell phones as part of their termination process. Employees transferring or promoting within the City must re-establish their eligibility in their new position.

#### 2. Determination of Phone or Plan

- a. The City Administrator is responsible for projecting business use, and for communicating this estimate to the Purchasing Officer. The Purchasing Officer is responsible for purchasing City-owned cell phones and establishing plans with providers that best meet the City's business needs at the lowest cost.

#### 3. Use of Cell Phone

- a. Except for incidental personal use, City-owned cell phones shall be used for business purposes only. Incidental personal use is defined as use that is infrequent and insubstantial. Incidental personal use phone calls shall be made at times that do not adversely affect the performance of official duties and are brief in duration and frequency. Whenever possible, incidental personal calls shall be made during breaks. Use of a City-owned cell phone for non-City business, or more than incidental personal use, will result in the entire cost of the phone and plan to be added to the employee's taxable wages as a taxable fringe benefit.
- b. Employees are prohibited from Speaking or listening or sending, reading, or writing text message to a cell phone while driving except as authorized by applicable laws



## City of Stevenson Personnel Policy

- c. Employees who are charged with traffic violations resulting from the use of their cell phone while driving will be solely responsible for all associated liabilities.
- d. In many cases, cell phones operate as a camera or as a way to access the internet or email. Employees operating a City-owned cell phone in these capacities must comply with the City's policy regarding "Internet Access," and "Email."
- e. There are certain cell phone uses that are prohibited and can result in disciplinary action at the discretion of the City Administrator. They include:
  - Commercial use other than City business.
  - Harassment of any member of the public, any governmental employee or any vendor.
  - Making or receiving any calls of a sexually explicit nature.
  - Inappropriate language including obscenity, vulgarity, profanity or expressions of ill will.
  - Subjects of political nature.
  - Misrepresentations or release of information of a confidential nature.
  - Speaking or listening or sending, reading, or writing text message to a cell phone while driving except as authorized by applicable laws.

#### 4. City Paid Monthly Stipend for Use of Personal Mobile Phones

- a. At the department director's discretion employees who would otherwise be provided with a City issued mobile phone can request to receive a monthly stipend for using their personal mobile phone for City business. The monthly stipend is paid through the payroll system as a taxable benefit, and the amount of the monthly stipend is based on one of two plan options as determined appropriate by the employee's director, or designee:

- A. Phone only
- B. Phone with data

The amount of the monthly stipend will equal the rate of the plan paid by the city, inclusive of taxes. Employees who receive a monthly stipend agree to purchase a device that meets the City's technical standards and use their personal phone for City business. In addition, employees must execute a Monthly Mobile Phone Stipend Agreement to be submitted to the employee's manager/supervisor for approval. The monthly stipend process is administered and overseen by the Payroll Officer.



## City of Stevenson Personnel Policy

### **Special Responsibilities for Managerial Staff**

As with any policy, management staff is expected to serve as role models for proper compliance with the provisions above and are encouraged to regularly remind employees of their responsibilities in complying with this policy.

Public Records Act – Employees should be aware that work-related texts and voice messages on cell phones are public records subject to the Public Records Act. Employees have a duty to maintain such records in accordance with the Washington Local Government Record Retention Schedules.





## City of Stevenson Personnel Policy

### RECEIPT OF THE CITY OF STEVENSON'S CELL PHONE USE POLICY

*Please read the policy carefully to ensure that you understand the policy before signing this document.*

I certify that I have received a copy of the City of Stevenson's Cell Phone Use Policy. I understand that it is my responsibility to read and comprehend this policy. I read and understand the content, requirements, and expectations of the Policy and I agree to abide by the Policy guidelines. I understand that if at any time I have questions regarding the Policy, I will consult with my immediate supervisor or the Personnel Office.

**I agree to observe and follow the Cell Phone Use Policy. I understand that failure to abide by the policy could result in the loss of cell phone privileges and/or other disciplinary actions.**

---

Employee Name (Signature)

---

Employee Name (Please Print)

---

Department

---

Date



# City of Stevenson Personnel Policy

## Appendix # A-5

City of Stevenson  
Ordinance No. 879

**An ordinance of the City of Stevenson adopting policies and procedures for reporting improper governmental action and protecting employees against retaliatory action.**

### Recitals

1. Chapter 44, Laws of 1992, entitled “The Local Government Employee whistleblower Act,” became effective for local governments on January 1, 1993.
2. Under the Local Government Employee Whistle blower Act it is unlawful for a local government to take retaliatory action because an employee, in good faith and in conformance with the local government’s procedures, provides information that improper government action may have occurred; and
3. Under the Local Government Employee Whistleblower Act local governments must enact specific policies for reporting improper government actions.

Now, Therefore, the City Council of the City of Stevenson do ordain as follows:

1. Policy statement. It is the policy of the City of Stevenson to:
  - 1.1 Encourage reporting by its employees of improper governmental action taken by City of Stevenson officers or employees; and
  - 1.2 Protect City of Stevenson employees who have reported improper governmental actions in accordance with the City of Stevenson’s policies and procedures from retaliatory action.
2. Definitions. As used in this policy, the following terms shall have the meanings indicated:
  - 2.1 “Improper governmental action”: means any action by a City of Stevenson Officer or employee
    - a. That is undertaken in the performance of the officer’s or employee’s official duties, whether or not the action is within the scope of the employee’s employment; and
    - b. That (i) is in violation of any federal, state, or local law or rule, (ii) is an abuse of authority, (iii) is of substantial and specific danger to the public health or safety or (iv) is a gross waste of public funds.
  - 2.2 “Improper governmental action” does not include personnel actions, including employee grievances, complaints, appointments, promotions, transfers, assignments, reassignments, reinstatements, restorations, reemployments, performance evaluations, reductions in pay, dismissals, suspension, demotions, violations of collective bargaining or civil service laws, alleged violations of labor agreements or reprimands.
  - 2.3 “Retaliatory Action” means any adverse change in the terms and conditions of a City of Stevenson employee’s employment.
  - 2.4 “Emergency” means a circumstance that if not immediately changed may cause damage to persons or property.
3. Procedures for Reporting.
  - 3.1 City of Stevenson employees who become aware of improper governmental actions should raise the issue first with their supervisor. Except in the event of an emergency, the employee shall also submit a written report to the supervisor, or to the City of Stevenson, stating in detail the basis for the employee’s belief that an improper governmental action has occurred. Where the employee reasonably believes the improper governmental action involves his or her supervisor, the employee may raise the issue directly with the City of Stevenson administrator, mayor or such other person as may be designated by the City of Stevenson administrator to receive reports of improper governmental action.
  - 3.2 In the case of an emergency, where the employee believes that damage to persons or property may result if action is not taken immediately, the employee may report the improper governmental action directly to the appropriate government agency with responsibility for investigation of the improper action.



## City of Stevenson Personnel Policy

- 3.3 The supervisor, the City of Stevenson administrator, mayor or the City of Stevenson administrator's designee, as the case may be, shall take prompt action to assist the City of Stevenson in properly investigating the report of improper governmental action. City of Stevenson officers and employees involved in the investigation shall keep the identity of reporting employees confidential to the extent possible under law, unless the employee authorizes the disclosure of his or her identity in writing. After an investigation has been completed, the employee reporting the improper governmental action shall be advised of a summary of the results of the investigations, except that personnel actions taken as a result of the investigation may be kept confidential.
- 3.4 City of Stevenson employees may report information about improper governmental action directly to the appropriate government agency with responsibility for investigating the improper action if the City of Stevenson employee reasonably believes that an adequate investigation was not undertaken by the City of Stevenson to determine whether an improper governmental action occurred, or that insufficient action has been taken by the City of Stevenson to address the improper governmental action or that for other reasons the improper governmental action is likely to recur.
- 3.5 CITY OF STEVENSON EMPLOYEES WHO FAIL TO MAKE A GOOD-FAITH ATTEMPT TO FOLLOW THE CITY OF STEVENSON'S PROCEDURES IN REPORTING IMPROPER GOVERNMENTAL ACTION SHALL NOT RECEIVE THE PROTECTION PROVIDED BY THE CITY OF STEVENSON IN THESE PROCEDURES
4. Protection Against Retaliatory Actions.
- 4.1 City of Stevenson officials and employees are prohibited from taking retaliatory action against a City of Stevenson employee because he or she has in good faith reported an improper governmental action in accordance with these policies and procedures.
- 4.2 Employees who believe that they have been retaliated against for reporting an improper governmental action should advise their supervisor, the City of Stevenson administrator, mayor or the City of Stevenson administrator's designee. City of Stevenson officials and supervisors shall take appropriate action to investigate and address complaints or retaliation.
- 4.3 If the employee's supervisor, the City of Stevenson administrator, or the City of Stevenson administrator's designee, as the case may be, does not satisfactorily resolve a City of Stevenson employee's complaint that he or she has been retaliated against in violation of this policy, the City of Stevenson employee may obtain protection under this policy and pursuant to state law by providing a WRITTEN notice to the City of Stevenson council that:
- Specifies the alleged retaliatory action; and
  - Specifies the relief requested.
- 4.4 City of Stevenson employees shall provide a copy of their written charge to the City of Stevenson mayor no later than thirty (30) days after the occurrence of the alleged retaliatory action. The city of Stevenson shall respond within thirty (30) days to the charge of retaliatory action.
- 4.5 After receiving either the response to the City of Stevenson or thirty (30) days after the delivery of the charge to the City of Stevenson, The City of Stevenson employee may request a hearing before a state administrative law judge to establish that a retaliatory action occurred and to obtain appropriate relief provided by law. An employee seeking a hearing should deliver the request for hearing to the City of Stevenson administrator within the earlier of either fifteen (15) days of delivery of the City of Stevenson's response to the charge of retaliatory action, or forty-five days of delivery of the charge for retaliation to the City of Stevenson for response.
- 4.6 Upon receipt of request for hearing, the City of Stevenson shall apply within five (5) working days to the Sate Office of Administrative Hearings for an adjudicative proceeding before an administrative law judge:
- Office of Administrative Hearings  
PO Box 42488, 4224 Sixth SE  
Row Six, Bldg. 1  
Lacey, WA 98504-2488  
206-459-6353
- 4.7 The City of Stevenson will consider any recommendation provided by the administrative law judge that the retaliator be suspended with or without pay, or dismissed.



# City of Stevenson Personnel Policy

- 5. Responsibilities. The city Administrator is responsible for implementing the City of Stevenson’s policies and procedures for reporting improper governmental action and for protecting employees against retaliatory action. This includes ensuring that this policy and these procedures are permanently posted where all employees will have reasonable access to them are made available to any employee upon request and are provided to all newly-hired employs. Officers, manager and supervisors are responsible for ensuring the procedures are fully implemented within their areas of responsibility. Violations of this policy and these procedures may result in appropriate disciplinary action, up to and including dismissal.
- 6. List of Agencies. The City Administrator will maintain a list of agencies responsible for enforcing federal, state and local laws and investigating other issues involving improper governmental action. Said list will be updated not less frequently than annually and copies thereof shall be made available to all employees. Employees having questions about these agencies or the procedures for reporting improper governmental action are encouraged to contact agencies shown on the list.

PASSED by the Council of the City of Stevenson and approved by the Mayor this 18<sup>th</sup> day of February, 1993.

\_\_\_\_\_  
Mayor of the City of Stevenson

ATTEST:

APPROVED AS TO FORM:

\_\_\_\_\_  
Clerk of the City of Stevenson

\_\_\_\_\_  
Attorney for the City of Stevenson



# City of Stevenson Personnel Policy

## Appendix # A-6

### LIST OF AGENCIES RESPONSIBLE FOR ENFORCING FEDERAL, STATE and LOCAL LAWS and INVESTIGATING OTHER ISSUES INVOLVING IMPROPER GOVERNMENTAL ACTION

#### LOCAL

City of North Bonneville  
Mayor  
North Bonneville City Hall  
PO Box 7  
North Bonneville, WA 98639  
509-427-8182  
City Attorney 509-427-5665

City of Stevenson  
Mayor  
Stevenson City Hall  
PO Box 371  
Stevenson, WA 98648  
509-427-5970  
City Attorney 509-427-5665

#### SKAMANIA COUNTY

Commissioners  
Skamania County Courthouse  
PO Box 790  
240 NW Vancouver Avenue  
Stevenson, WA 98648  
509-427-9447

Prosecuting Attorney  
Skamania County Courthouse  
PO Box 790  
240 NW Vancouver Avenue  
Stevenson, WA 98648  
509-427-9405

Sheriff  
Skamania County Sheriff's Office  
PO Box 790  
200 NW Vancouver Ave  
Stevenson, WA 98648  
509-427-9490

Port of Skamania County  
Chairman Board of Port Commissioners  
PO Box 1099  
130 SE Cascade Avenue  
Stevenson, WA 98648  
509-427-5484

Public Utility District No. 1  
of Skamania County  
Chair, Board of PUD Commissioners  
PO Box 500 Wind River Highway  
Carson, WA 98610  
509-427-5126

#### STATE OR REGIONAL AGENCIES

Washington State Attorney General  
111 NE Olympia Avenue  
Olympia, WA 98501  
360-753-6210

Washington State Department of Ecology  
PO Box 47600  
Olympia, WA 98504  
360-459-6000

Washington State Department of Natural Resources  
PO Box 47000  
Olympia, WA 98504  
360-902-1000

Washington State Department of Transportation  
Transportation Building  
KF-01  
Olympia, WA 98504  
360-705-7000

Washington State Department of  
Community Development  
9<sup>th</sup> & Columbia  
MSGH-51  
Olympia, WA 98504  
360-725-2800

Southwest Washington Air Pollution  
Control Authority  
1308 NE 134<sup>th</sup>, Suite D  
Vancouver, WA 98685  
800-633-0709



# City of Stevenson Personnel Policy

Southwest Washington Health District  
PO Box 5000  
Vancouver, WA 98663  
360-695-9215

Washington State Department of Fisheries  
115 General Administration Bldg.  
MS AX-11  
Olympia, WA 98504  
360-753-6600

Washington State Auditor's Office  
Legislative Building  
PO Box 40021  
Olympia, WA 98504-0021

Washington State Department of Health  
Health Consumer Assistance  
PO Box 4789  
Olympia, WA 98504  
800-525-127

Washington State Liquor Control Board  
Enforcement Division  
1514 E. Street  
Vancouver, WA 98666

## FEDERAL AGENCIES

Department of Agriculture  
Office of Inspector General  
915 Second Avenue  
Seattle, WA  
Supervisor Auditor  
360-553-8290  
Supervisor Special Agent  
360-553-8286

Alcohol Tobacco & Firearms  
Criminal Enforcement  
915 Second Avenue  
Seattle, WA  
360-553-4485

Department of Commerce Commission  
Office of the Inspector General  
Office of Audits  
915 Second Avenue  
Seattle, WA  
360-553-0801  
Fraud Hotline 800-424-5454

US Department of Education  
Office of Inspector General  
915 Second Avenue  
Seattle, WA  
Audits 360-553-0657  
Investigations 360-553-1482

Washington State Employment Security  
Bingen Job Service Center  
PO Box 847  
Bingen, WA 98605  
509-493-1210

Washington State Utilities Transportation  
Chandler Building, MS FY-11  
13005 Evergreen Park Dr. SW  
Olympia, WA 98504  
360-753-6423

Washington State Human Rights Commission  
402 Evergreen Plaza Bldg.  
Olympia, WA 98504-2490  
360-753-6770

Washington State Dept. of Labor & Industries  
General Administration  
Building, MS, HC-101  
Olympia, WA 98505  
360-753-6341

Washington State Department of Social & Health  
Services; Special Investigation Office  
11900 NE 95th  
PO Box 4485  
Vancouver, WA 98662  
360-696-6707

Department of Army  
Corp of Engineers  
PO Box 2946  
319 Pine  
Portland, OR 97225  
503-326-6000

US Attorney  
800 Fifth Avenue  
Seattle, WA  
360-553-7970

Consumer Product Safety  
Hotline 800-638-2772  
US Customs Service  
Office of Enforcement  
909 First Avenue  
Seattle, WA  
360-653-7531

Environmental Protection Agency  
Criminal Investigations  
1200 Sixth Avenue  
Seattle, WA





# City of Stevenson Personnel Policy

Equal Employment Opportunity Agency  
2815 Second, Suite 500  
Seattle, WA  
360-553-0968

US Department of Energy  
Bonneville Power Administration  
PO Box 3621  
Portland, OR 97208  
360-230-3000

General Accounting Office (GAO)  
1500 NE Irving Street  
Portland, OR 97232  
503-235-8500

Department of Health & Human Services  
Food & Drug Administration  
22201 23<sup>rd</sup> Drive SE  
Bothell, WA  
Trade Complaints 206-483-4949  
Audits: 360-553-0452

US Bureau of Indian Affairs  
PO Box 3785  
Portland, OR 97208  
503-231-6702

Department of Interior US Fish & Wildlife Services  
Division of Law Enforcement  
121 107<sup>th</sup> NE  
Bellevue, WA

Department of Justice  
Drug Enforcement Administration  
220 West Mercer, Suite 300  
Seattle, WA  
360-553-5443

Mine Safety & Health Administration  
117 107<sup>th</sup> NE  
Bellevue, WA  
360-553-7037

National Transportation Safety Board of Directors  
19518 Pacific Highway South  
Seattle, WA  
360-764-3782

Department of Transportation  
Office of Inspector General  
915 Second Avenue  
Seattle, WA 98178  
360-553-5720

Federal Emergency Management Agency  
130 – 228<sup>th</sup> Street SW  
Bothell, WA  
360-487-4600

General Services Administration  
915 Second Avenue  
Seattle, WA  
Investigations: 360-931-7654  
Law Enforcement: 360-553-0290  
Audits: 360-931-7650

Department of Housing and Urban Development  
Office of Counsel  
1321 Second Avenue  
Seattle, WA  
Audits 360-553-0270  
Investigations: 360-553-0272

Interstate Commerce Commission  
915 Second Avenue-Room 1894  
Seattle, WA 98154  
360-553-5421

Federal Bureau of Investigation (FBI)  
1500 SW 1<sup>st</sup> Avenue  
Portland, OR 97201  
503-224-4181

Department of labor  
Occupational Safety & Health (OSHA)  
1111 Third Avenue, Suite 715  
Seattle, WA 98101-3212  
360-553-5930  
Audits  
1111 Third Avenue, Suite 780  
Seattle, WA 98101-3212  
360-553-4880  
Investigations  
1111 Third Avenue, Suite 785  
Seattle, WA 98101-3212

Nuclear Regulatory Commission  
510-975-0200  
Federal Trade Commission  
915 Second Avenue  
Seattle, WA  
360-553-4656

Department of Treasury  
Bureau of Alcohol, Tobacco & Firearms  
Law Enforcement Division  
915 Second Avenue – room 806  
Seattle, WA 98174



# City of Stevenson Personnel Policy

Department of Veterans Affairs  
Office of Inspector General  
915 Second Avenue  
Seattle, WA 98674  
Fraud/Waste/Abuse Hotline  
800-488-8244

Securities & Exchange Commission  
Seattle, WA 98174  
360-553-7990



# City of Stevenson Personnel Policy

## Appendix # A-7

### Travel Reimbursement Request

*(To be turned in to Accounts Payable after travel is complete to request reimbursement)*

**Name:** \_\_\_\_\_

**Event:** \_\_\_\_\_

**Location:** \_\_\_\_\_

**Dates:** \_\_\_\_\_

	<b>Paid by City</b>	<b>Reimbursement</b>
<b>Tuition, Registration, Etc.</b> \$ _____	_____	-
Back up Documentation Required		
<b><u>Lodging: Receipts Required</u></b>		
# of nights ____ @ _____ per night	_____	-
Less charges for non official companions:	-	-
State Lodging Per Diem Rate: \$ _____	Higher Rate of: \$ _____	
	Approved by City Council: _____	
<b><u>Travel: Receipts required for all except vehicles.</u></b>		
Personal Vehicle: # of Miles: _____ per mile	-	-
City Vehicle: _____	-	-
Public Transportation: _____	-	-
Round Trip Airfare: _____	-	-
Parking Fees: _____	-	-
<b><u>Per Diem Meals ... No Receipts Required</u></b>		
___ Breakfasts at \$ _____ each	-	\$0.00
___ Lunches at \$ _____ each	-	\$0.00
___ Dinners at \$ _____ each	-	\$0.00
Meals included in Tuition: _____		
<b><u>Total Expenses:</u></b>	<u>\$0.00</u>	<u>\$0.00</u>

Please note where you are required to return receipts. Reimbursements will not be made if the expenses requested exceed the amount approved by City Council. City Council must approve rates higher than the State Per Diem.

Supervisor Approval: \_\_\_\_\_  
 Date of City Council Approval (if req'd): \_\_\_\_\_

Final Reimbursement Requested: (After travel is complete) \* \$ \_\_\_\_\_  
 Requested by: \_\_\_\_\_ (signature)  
 \* Limited to amount approved above by Supervisor or City Council



# City of Stevenson Personnel Policy

## Appendix # A-8

### CITY ADMINISTRATOR

**POSITION:** City Administrator  
**REPORTS TO:** Mayor  
**EFFECTIVE DATE:** June 21, 2018  
**FLSA STATUS:** Exempt

#### SUMMARY:

This is a professional administrative/management level position requiring experience and training in government management, fiscal/accounting systems operations, contract management, program design and development, grant writing and administration, personnel administration and general policy research for the City Council. Oversees all City operations and reports directly to the Mayor and Council.

#### ESSENTIAL JOB DUTIES:

The specific statements shown for each task are not intended to be all inclusive. They represent minimal essential elements and criteria considered necessary to successfully perform the job. Other related duties and responsibilities may be required, or assigned, as needed.

- Responsible for general governmental accounting, accounting systems, records, purchasing and payroll.
- Assist the Mayor in conducting all the city's business and performs such other duties and assumes such other responsibilities as the Mayor shall direct and as may be required by ordinances and resolutions passed by the City Council.
- Serve as the City's Clerk/Treasurer.
- Responsible for the preparation of monthly, quarterly, and annual fiscal reports.
- Monitor budgets.
- Generate information for other federal, state and local reports.
- Oversee issuance of debt, maintaining debt payments and debt ceilings.
- Oversee budget preparation and prepare final budget documents including preparation of financial forecasts for short- and long-term fiscal goals and conditions.
- Audit all City expenditures.
- Supervise all overall operations of the City.
- Interpret rules, policies, procedures of city functions and research data, laws, codes, regulations, and polices for the City Council in their policy making decisions.
- Serve as an advisor to the City council and its various boards and commissions.
- Responsible for maintaining consistency among the City's various boards and departments.
- Supervise the various department heads and acts as a technical resource.
- Manage City's contracts for compliance and performance.
- Negotiate contracts.
- Administrative responsibility for all contract management.
- Develop programs as directed by Council.



## City of Stevenson Personnel Policy

- Prepare program proposals, budgets, implementation schedules, and evaluations.
- Perform special projects as assigned by council or insure implementation by appropriate city departments.
- Monitor performance and activities of department heads to ensure goals are met.
- Provide grant management for all city functions including research of grant opportunities, preparation of grant applications, and the administration of grants.
- Responsible for oversight of the city personnel and personnel system including supervision of department heads including scheduling, evaluations, staff training, and general strategic planning.
- Oversee the development and maintenance of general personnel policy and management issues.
- Oversee compliance with local, state and federal regulations and manages recruitment/dismissal issues.
- Administer contracts for liability, health, and other benefit programs.
- Maintain City compliance with Federal and State mandates.
- Prepare City Ordinances and Resolutions.
- Act as risk manager and maintain accident files.
- Oversee City coordination of land use reviews, subdivisions, short plats, comprehensive plan issues, various environmental permits, and Columbia River Gorge National Scenic Area regulations within the various city departments and with external parties.
- Attend all City Council meetings.
- Represent City on various boards and committees as directed by the City Council.
- Act as a liaison with other governmental organizations.
- Respond to citizen complaints and inquiries and coordinates council responses to these complaints.
- Serve with the Community Development Director and Public Works Director to coordinate emergency management and hazard mitigation planning/implementation.

### ABILITY TO:

- Maintain confidentiality
- Work independently
- Appropriately and efficiently delegate responsibility
- Gauge project progress and make adjustments to meet deadlines
- Communicate clearly and effectively both orally and in writing
- Establish and maintain effective working relationships
- Work courteously and tactfully with customers and employees.
- Exercise discretion in confidential or sensitive situations
- Adapt to new technologies and policy changes.
- Maintain records and prepare reports.
- Demonstrate excellent problem solving and follow through skills.
- Prioritize work, mesh numerous assignments, cope with interruptions, last minute changes and deadlines.



# City of Stevenson Personnel Policy

- Exhibit proficient computer skills.

### SUPERVISORY RESPONSIBILITIES:

Responsible for directly supervising Directors, Department Heads and office staff; provide daily direction and guidance, make approvals and recommendations as needed. Indirectly supervise all remaining city staff; maintain and promote team-centered participatory management practices, delegating maximum responsibility to those in supervisory positions.

### JOB CONDITIONS:

This position takes place in a typical office environment. The position may require long periods of sitting, standing, stooping, and/or reaching. This position may also require lifting objects weighing more than twenty-five (25) pounds.

Evening meetings and substantial overtime may be required.

### MINIMUM QUALIFICATIONS:

- College Graduate, previous government experience
- Must have good accounting knowledge, management experience,
- Communication skills
- Leadership and analytical skills
- Experience with standard office equipment including computers

### PREFERRED QUALIFICATIONS:

- Grant Writing Experience
- Master's degree in a related field

### POSSESSION OR ABILITY TO ACQUIRE WITHIN 18 MONTHS OF EMPLOYMENT:

- First Aid & CPR Certification

This job description does not constitute an agreement between the employer and the employee and in no way implies that these are the only duties to be performed. Employees occupying the position will be required to follow any other job-related instructions and to perform any other job-related duties requested by their supervisor.

**I have read and understood the functions, responsibilities and requirements of this position.**

\_\_\_\_\_  
Signature

\_\_\_\_\_  
Date





# City of Stevenson Personnel Policy

## PUBLIC WORKS DIRECTOR

**POSITION:** Public Works Director  
**REPORTS TO:** City Administrator  
**EFFECTIVE DATE:** June 21, 2018  
**FLSA STATUS:** Exempt

### SUMMARY:

The position is responsible for planning, directing and coordinating the Public Works Department activities including the construction, maintenance, operation and repair of city streets, storm water system, vehicle fleet, parks and buildings, water and sewer systems and serving as the liaison with the emergency management services. The position needs management and supervisory experience.

### ESSENTIAL JOB DUTIES:

The specific statements shown for each task are not intended to be all inclusive. They represent minimal essential elements and criteria considered necessary to successfully perform the job. Other related duties and responsibilities may be required or assigned, as needed.

- Plan, organize, direct and control the activities, operations, and personnel of the City Public Works Department, in cooperation with City leadership.
- Develop and implement long term planning for the City's public works facilities including execution of both short and long-range construction programs.
- Serve as a key member of the City's management team.
- Supervise the operation of the Street, Equipment Services, Water, Sewer and Storm Water departments.
- Oversee the selection, training, professional development and certification programs for all department personnel and provide guidance to the Public Works Field Supervisor and system managers.
- Ensure that appropriate policies and procedures are in place and ensure employee compliance to department policies and procedures.
- Work closely with Public Works Field Supervisor and system managers to develop and implement appropriate policies and procedures for each respective division of the department.
- Serve as the technical advisor to the Mayor, City Council, City Administrator and departments on public works activities.
- Perform cost control activities and monitor the efficiency/effectiveness of the above departments including assisting the finance department with budgeting for the public works departments.
- Attend all City Council meetings and represent the City on other committees as assigned.
- Direct the research and compilation of all required reports relative to the operation of the public works programs.
- Ensure that the City's water and sewer utilities meet all regulatory requirements.



## City of Stevenson Personnel Policy

- Supervise public works construction projects.
- Direct the preparation of public notices and information programs to ensure that citizens, contractors, businesses and interested parties are apprised of major projects.
- Prepare written reviews of all subdivision and short plat applications for the planning advisor.
- Review and approve building permit applications for public works compliance.
- Serve with the Community Development Director and City Administrator to coordinate emergency management and hazard mitigation planning/implementation.
- Serve as the enforcement officer for the protection of public facilities.
- Assist with the control of public nuisances.
- Respond to public inquires related to public works issues.
- Assist with grant writing.
- Perform field work in all public works departments as needed. (i.e. streets, water/sewer, equipment service).

### ABILITY TO:

- Analyze and problem solve problems relating to Public Works functions
- Efficiently coordinate resources and personnel to accomplish projects
- Assign, schedule, direct, coordinate, and evaluate workers performing various maintenance and repair activities at various skill levels
- Appropriately and efficiently delegate responsibility
- Gauge project progress and make adjustments to meet deadlines
- Communicate effectively both orally and in writing
- Establish and maintain effective working relationships
- Work courteously and tactfully with customers and employees.
- Confidently make informed decisions and/or recommendations regarding all Public Works functions
- Speak, understand, read, and write English
- Perform basic math (add, subtract, multiply, and divide)
- Exercise discretion in confidential or sensitive situations
- Exercise independent judgment and/or independent action
- Maintain various health and safety standards and regulations
- Perform moderately, strenuous physical tasks.
- Read, analyze and interpret financial reports, legal documents, engineering reports, and blue prints.
- Secure compliance with construction specifications in an effective manner.

### SUPERVISORY RESPONSIBILITIES:

Responsible for directly supervising the Public Works Field Supervisor, system managers and subcontractors; provide daily direction and guidance, make approvals and recommendations as needed. Indirectly supervise all maintenance worker positions in the department; maintain and promote team-centered participatory management practices, delegating maximum responsibility to those in supervisory positions.



# City of Stevenson Personnel Policy

## JOB CONDITIONS

On call status, evening meetings, and substantial overtime may be required. The incumbent may experience exposure to high noise levels, extreme temperatures, work around machinery and high traffic, harmful gasses and fumes, confined spaces, and exposure to blood-borne pathogens. Extensive computer work is required, including eight or more hours per week being devoted to clerical work such as typing, filing, data entry, and report writing. Although work will be performed in an office setting, due to the small size of the City, “on-site” supervisory and inspection duties will need to be performed and may lead to considerable time spent out-of-doors. During the occasional emergency the director may be exposed to extreme weather and work conditions.

This position may also require pushing, pulling, lifting and carrying objects weighing up to fifty (50) pounds.

## MINIMUM QUALIFICATIONS:

- High School graduate or GED equivalent.
- 3 or more years progressively responsible experience in a public works-related position and demonstrated management responsibilities.
- Good knowledge of civil engineering procedures and practices relating to design, construction and operation of public works facilities; and, good knowledge of state and federal laws and procedures relating to public works.
- Computer literate with general knowledge of public works software applications.
- Familiarity with government budgeting, regulatory environment and report preparation.
- Supervisory skills, including evaluation, discipline and discharge.
- Must have a valid a valid state issued Driver’s License.

## PREFERRED QUALIFICATIONS:

- Bachelor degree from accredited college or University in Business Management, Civil Engineering, Planning or related field or demonstrated equivalent in formal education and experience.

## POSSESSION OR ABILITY TO ACQUIRE WITHIN 18 MONTHS OF EMPLOYMENT:

- First Aid & CPR Certification
- Flagger Certification
- Water Plant Operator I (WTPO I)
- Wastewater Treatment Plant Operator I (WWTPO I)
- Water Distribution Manager I (WDM I)

## POSSESSION OR ABILITY TO ACQUIRE WITHIN 5 YEARS OF EMPLOYMENT

- Water Plant Operator II (WTPO II)
- Wastewater Treatment Plant Operator II (WWTPO II)



## City of Stevenson Personnel Policy

This job description does not constitute an agreement between the employer and the employee and in no way implies that these are the only duties to be performed. Employees occupying the position will be required to follow any other job-related instructions and to perform any other job-related duties requested by their supervisor.

**I have read and understood the functions, responsibilities and requirements of this position.**

\_\_\_\_\_  
Signature

\_\_\_\_\_  
Date



# City of Stevenson Personnel Policy

## COMMUNITY DEVELOPMENT DIRECTOR

**POSITION:** Community Development Director  
**REPORTS TO:** City Administrator  
**EFFECTIVE DATE:** June 21, 2018  
**FLSA STATUS:** Exempt

### SUMMARY:

Performs current and long-range planning functions related to the City's growth, development and change. Creates and facilitates programs and systems to improve the physical environment (public infrastructure, environmental protection, private investments), human/social capacity (public dialogue, civic involvement), and economic vitality of the community. Engages community stakeholders on emerging issues and relates community needs to City elected and appointed officials.

### ESSENTIAL JOB DUTIES:

The specific statements shown for each task are not intended to be all inclusive. They represent minimal essential elements and criteria considered necessary to successfully perform the job. Other related duties and responsibilities may be required, or assigned, as needed.

- Current Planning:
  - Act as ordinance administrator and ensuring compliance under SMC Title 16, Title 17, Title 18, and other/future ordinances as assigned.
  - Advise the public on City regulatory requirements.
  - Ensure that a comprehensive public record is developed and retained by the City through the carrying out of the required notices, reviews, assessments, and impact statements as authorized by the City.
- Long-Range Planning:
  - Develop programs (e.g. facilitative, informational, regulatory) necessary to implement the City's Comprehensive Plan.
  - Maintain compliance with state-mandated land use and environmental statutes.
  - Develop the community's capacity to engage in informed, shared decision-making.
  - Assist with development of Capital Improvement Programs to align with land use patterns and community need.
- Grant Writing:
  - Lead and assist with grant sourcing, project conceptualization/development, and preparing grant narratives and submittals.
- Testify as expert witness in court if required or assisting with the preparation of City lawsuits involving land use issues.
- Attend all City Council meetings and represent the City on various boards and committees.
- Managing and assisting with special projects and programs as assigned.
- Serve as a key member of the City's management team.
- Assist with the control of public nuisances.



## City of Stevenson Personnel Policy

- Serve with the Public Works Director and City Administrator to coordinate emergency management and hazard mitigation planning/implementation.

### ABILITY TO:

- Communicate clearly, effectively, and tactfully both verbally and in writing.
- Exhibit proficient computer skills.
- Work independently with little direction.
- Prioritize work, mesh numerous assignments, cope with interruptions, last minute changes and deadlines.
- Obtain training to update present skills or obtain new skills.
- Demonstrate excellent problem solving and follow through skills.
- Determine appropriate action within clearly defined guidelines.
- Observe health and safety regulations.
- Maintain records and prepare reports.
- Work courteously and tactfully with customers and employees.
- Establish and maintain cooperative and effective working relationships with others.
- Adapt to new technologies and policy changes.
- Exercise discretion in confidential or sensitive situations
- Exercise independent judgment and/or independent action
- Read, analyze and interpret financial reports, legal documents, engineering reports, and blue prints.

### SUPERVISORY RESPONSIBILITIES:

Occasionally exercises supervision over consultants, volunteers, interns, temporary and part-time employees.

### JOB CONDITIONS:

Work is performed primarily in an office environment and approximately 15% performing site visits and/or meetings. Attendance at evening meetings is required, occasional attendance at meetings and trainings that occur outside City boundaries and substantial overtime may be required.

The duties of the position require sitting, walking, stooping, crawling, bending, reaching, pulling, twisting, and the ability to lift up to 25 pounds. Must be able to traverse all types of terrain, in all types of weather, when performing site visits/inspections. Requires finger dexterity, sense of touch, gripping with fingers and hands, ability to see, hear voice conversation, and to speak. Will require sitting for prolonged periods of time, extensive use of computer keyboard.

### MINIMUM QUALIFICATIONS:

Graduation from an accredited 4-year college/university with a degree in land use planning, urban planning, geography, environmental studies or a closely related field which would provide the applicant with the desired skills, knowledge and ability required to perform the job.

Three (3) or more years of work in land use planning.

Working knowledge of:





## City of Stevenson Personnel Policy

- Local land use planning principles, practices and techniques.
- Environmental sciences.
- Computer literacy.
- City government functions, policies, rules and regulations.
- State planning statutes and general familiarity with legal foundations of planning.
- Research methods and sufficient technical/analytical skills to interpret and prepare data for planning studies and reports/recommendations pertaining to land use control and EIS.

### PREFERRED QUALIFICATIONS:

Master's degree from an accredited college/university with a degree in land use planning, urban planning, geography, environmental studies or a closely related field  
American Institute of Certified Planners membership.

Working knowledge of:

- GIS, presentation, and infographic software.

### POSSESSION OR ABILITY TO ACQUIRE WITHIN 18 MONTHS OF EMPLOYMENT:

First Aid & CPR Certification

This job description does not constitute an agreement between the employer and the employee and in no way implies that these are the only duties to be performed. Employees occupying the position will be required to follow any other job-related instructions and to perform any other job-related duties requested by their supervisor.

**I have read and understood the functions, responsibilities and requirements of this position.**

\_\_\_\_\_  
Signature

\_\_\_\_\_  
Date



## City of Stevenson Personnel Policy

### DEPUTY CLERK/TREASURER

**POSITION:** Deputy Clerk/Treasurer  
**REPORTS TO:** City Administrator  
**EFFECTIVE DATE:** June 21, 2018  
**FLSA STATUS:** Non-Exempt

#### SUMMARY:

This is an office position that acts as primary assistant to the city administrator and performs a variety of functions to such as assisting with the maintenance of the city accounting system, managing investments, responding to public inquiries, monitoring municipal court activity, assisting with records maintenance, creating and filing general city records. Fills in for the city administrator in his/her absence.

#### ESSENTIAL JOB DUTIES:

The specific statements shown for each task are not intended to be all inclusive. They represent minimal essential elements and criteria considered necessary to successfully perform the job. Other related duties and responsibilities may be required or assigned, as needed.

- Receipt, reconcile and deposit incoming funds and maintain records as required.
- Review and code accounts payable.
- Prepare vouchers and checks
- Maintain daily postings to the general ledger.
- Assist with the preparation of monthly, quarterly and annual reports.
- Assist the Utility Clerk with the preparation and reconciliation of water and sewer billing and receipting, including maintaining all state and city records.
- Monitor reporting of court activity and reconcile against monthly court and jail billings.
- Fill in for the City Administrator when required.
- Assist the Fire Department, Building Inspector, Public Works Director and City Administrator when required.
- Assist in the preparation of the budget, financial reports and annual state audit.
- Purchase office and household supplies.
- Monitor city purchases for compliance with City/State bid laws.
- Provide front counter customer service when needed.
- Evaluate monthly cash flows and interest rates to invest city funds and maintain records.
- Assist City Administrator with the investing of City funds
- Operate office equipment, trouble shoot hardware software problems and operate Microsoft suite, court, financial and utility software programs.
- Assist with project administration, monitor compliance with state/federal prevailing wage laws, RCW's and WAC's.
- Assist City Administrator in grant management.
- Process public records requests.
- Prepare monthly payroll for city staff, maintaining all payroll files.



## City of Stevenson Personnel Policy

- Maintain city website and other city communication outlets.

### ABILITY TO:

- Communicate clearly, effectively, and tactfully both verbally and in writing.
- Exhibit proficient computer skills.
- Work independently with little direction.
- Prioritize work, mesh numerous assignments, cope with interruptions, last minute changes and deadlines.
- Demonstrate conflict-resolution, problem-solving, and interpersonal skills using tact, patience, and courtesy.
- Obtain training to update present skills or obtain new skills.
- Demonstrate attention to detail and an aptitude for numbers.
- Demonstrate excellent problem solving and follow through skills.
- Determine appropriate action within clearly defined guidelines.
- Observe health and safety regulations.
- Maintain records and prepare reports.
- Establish and maintain cooperative and effective working relationships with others.
- Adapt to new technologies and policy changes.

### SUPERVISORY RESPONSIBILITIES:

Works under general supervision. No formal supervisory responsibilities but may oversee or direct the work of support staff, contractors, and/or volunteers.

### JOB CONDITIONS:

This position takes place in a typical office environment. The position may require long periods of sitting, standing, stooping, and/or reaching. This position may also require lifting objects weighing more than twenty-five (25) pounds. Specific vision abilities required by this position include close vision and the ability to adjust focus.

This position may be subject to verbal abuse at times from the public.

### MINIMUM QUALIFICATIONS:

High School Graduate or GED equivalent.  
Office Experience, good writing skills, understanding of Generally Accepted Accounting Principles (GAAP)  
10-key by touch, computer experience (preferably Windows based Excel & Word)  
Good Customer Service

### PREFERRED QUALIFICATIONS:

Prior Government Accounting and Court Experience  
College graduate

### POSSESSION OR ABILITY TO ACQUIRE WITHIN 18 MONTHS OF EMPLOYMENT:



## City of Stevenson Personnel Policy

First Aid & CPR Certification  
Notary Public Designation

This job description does not constitute an agreement between the employer and the employee and in no way implies that these are the only duties to be performed. Employees occupying the position will be required to follow any other job-related instructions and to perform any other job-related duties requested by their supervisor.

**I have read and understood the functions, responsibilities and requirements of this position.**

\_\_\_\_\_  
Signature

\_\_\_\_\_  
Date



# City of Stevenson Personnel Policy

## UTILITIES CLERK

**POSITION:** Utilities Clerk  
**REPORTS TO:** City Administrator  
**EFFECTIVE DATE:** December 15, 2022  
**FLSA STATUS:** Non-Exempt

### SUMMARY:

This is an office position that performs a wide variety of regular and recurring accounting procedures; payroll and utility billing tasks; records management and permit technician duties.

### ESSENTIAL JOB DUTIES:

The specific statements shown for each task are not intended to be all inclusive. They represent minimal essential elements and criteria considered necessary to successfully perform the job. Other related duties and responsibilities may be required, or assigned, as needed.

- Provide outstanding, friendly customer service to all city customers.
- Responsible for utility billing including preparation and reconciliation of water and sewer billing, receipting payments, maintenance of customer service records and compiling reports.
- Maintain records of connections and utility applications with associated costs.
- Receive, account for and safeguard cash, checks and other valuables as required.
- Develop and maintain procedures for utility bills, delinquent billing reminders and service cut-offs.
- Review invoices submitted and determine proper account coding, prepare vouchers and checks for payment.
- Prepare monthly payroll for city staff, maintaining all payroll files.
- Perform confidential secretarial and administrative work of a varied nature including receive and screen telephone calls; establish and maintain files, records and other information sources needed to facilitate, support and document office or department activities.
- Perform secretarial services for various departments when required.
- Secretary to the Board of Adjustment and Board of Appeals committees and fill in for the Planning Commission/City Council when required.
- Assist in the preparation of the budget, financial reports and annual state audit.
- Maintain Business License, Small Works Roster and Outdoor Burn Files.
- Assist with records retention and maintains City Council cross reference indexes.
- Provide zoning information, building permit information, water/sewer information. Provide general public/tourist information and relocation assistance.
- Operate office equipment, trouble shoot hardware software problems and operate Microsoft suite software and utility/financial software programs.
- Assist with project administration, monitor compliance with state/federal prevailing wage laws, RCW's and WAC's.
- Assist City Administrator in grant management.



## City of Stevenson Personnel Policy

- Assist with asset management to include conducting an inventory, and logging information in spreadsheets.
- Calculate annual Volunteer Firefighter pay and Skamania County Fire District II billing.
- Maintain varied accounting office filing systems and records as directed to assure proper follow-through.
- Process and assist in the completion of applications for various city permits.
- Assist with maintaining the permit tracking database.

### ABILITY TO:

- Communicate clearly, effectively, and tactfully both verbally and in writing.
- Exhibit proficient computer skills.
- Work independently with little direction.
- Prioritize work, mesh numerous assignments, cope with interruptions, last minute changes and deadlines.
- Demonstrate conflict-resolution, problem-solving, and interpersonal skills using tact, patience, and courtesy.
- Obtain training to update present skills or obtain new skills.
- Demonstrate attention to detail and an aptitude for numbers.
- Demonstrate excellent problem solving and follow through skills.
- Determine appropriate action within clearly defined guidelines.
- Observe health and safety regulations.
- Maintain records and prepare reports.
- Work courteously and tactfully with customers and employees.
- Establish and maintain cooperative and effective working relationships with others.
- Adapt to new technologies and policy changes.

### SUPERVISORY RESPONSIBILITIES:

Works under general supervision. No formal supervisory responsibilities but may oversee or direct the work of support staff, contractors, and/or volunteers.

### JOB CONDITIONS:

This position takes place in a typical office environment. The position may require long periods of sitting, standing, stooping, and/or reaching. This position may also require lifting objects weighing more than twenty-five (25) pounds. Specific vision abilities required by this position include close vision and the ability to adjust focus.

This position may be subject to verbal abuse at times from the public.

### MINIMUM QUALIFICATIONS:

High School Graduate or GED equivalent.

Office Experience, good writing skills, understanding of basic accounting

10-key by touch, computer experience (preferably Windows based) excel & word

Good Customer Service





## City of Stevenson Personnel Policy

**PREFERRED QUALIFICATIONS:**

Prior Government Accounting Experience  
College graduate

**POSSESSION OR ABILITY TO ACQUIRE WITHIN 18 MONTHS OF EMPLOYMENT:**

First Aid & CPR Certification  
Notary Public Designation

This job description does not constitute an agreement between the employer and the employee and in no way implies that these are the only duties to be performed. Employees occupying the position will be required to follow any other job-related instructions and to perform any other job-related duties requested by their supervisor.

**I have read and understood the functions, responsibilities and requirements of this position.**

\_\_\_\_\_  
Signature

\_\_\_\_\_  
Date



# City of Stevenson Personnel Policy

## PLANNING AND PUBLIC WORKS ASSISTANT

**POSITION:** Planning and Public Works Assistant  
**REPORTS TO:** City Administrator  
**EFFECTIVE DATE:** December 15, 2022  
**FLSA STATUS:** Non-Exempt

### SUMMARY:

This is an office position that performs a wide variety of support for the Community Development Director, Public Works Director and City Administrator through clerical duties, records management, code enforcement and permit technician duties.

### ESSENTIAL JOB DUTIES:

The specific statements shown for each task are not intended to be all inclusive. They represent minimal essential elements and criteria considered necessary to successfully perform the job. Other related duties and responsibilities may be required, or assigned, as needed.

- Provide outstanding, friendly customer service to all city customers.
- Coordinate, track, and process permit applications ensuring that policies and procedures are followed in the receipt, routing, processing and recording of permit applications.
- Review applications for compliance with policies, such as Stevenson Municipal Code and Engineering Standards.
- Monitor application progress for status reports to the applicant and city departments on a regular basis.
- Calculate permit and plan review fees and ensure plans are reviewed by appropriate departments.
- Prepare and provide legal notices for a variety of applications.
- Plan and perform a variety of building and planning research functions, such as review of property ownership, easements and other land use matters.
- May approve and issue minor permits at the discretion of the Department Head, such as right of way and minor land use permits.
- Issue a permit after ensuring that all necessary approvals are obtained, all required documentation is complete, and all regulations are addressed.
- Initiate, create, recommend and document updates to policies and processes for permit applications.
- Prepare agendas and reports, compile and prepare meeting materials for distribution, prepare meeting locations, and update post-meeting documents.
- Attend meetings to take notes and compose clear, accurate and comprehensive minutes for various committees and boards.
- Perform confidential secretarial and administrative work of a varied nature including receive and screen telephone calls; establish and maintain files, records and other information sources needed to facilitate, support and document office or department activities.



## City of Stevenson Personnel Policy

- Secretary to the Board of Adjustment and Board of Appeals committees and fill in for the Planning Commission/City Council when required.
- Assist with records retention and maintain City Council cross reference indexes.
- Provide zoning information, building permit information, water/sewer information. Provide general public/tourist information and relocation assistance.
- Operate office equipment, trouble shoot hardware/software problems and operate Microsoft suite software and building permit and public works software programs.
- Assist with project administration, monitor compliance with state/federal prevailing wage laws, RCW's and WAC's.
- Assist City Administrator in grant management.
- Assist with asset management to include conducting an inventory, and logging information in spreadsheets and/or other asset tracking software.
- Intake, track, manage and coordinate responses to public nuisances.

### ABILITY TO:

- Communicate clearly, effectively, and tactfully both verbally and in writing.
- Exhibit proficient computer skills.
- Work independently with little direction.
- Prioritize work, mesh numerous assignments, cope with interruptions, last minute changes and deadlines.
- Demonstrate conflict-resolution, problem-solving, and interpersonal skills using tact, patience, and courtesy.
- Obtain training to update present skills or obtain new skills.
- Demonstrate attention to detail and an aptitude for numbers.
- Demonstrate excellent problem solving and follow through skills.
- Determine appropriate action within clearly defined guidelines.
- Observe health and safety regulations.
- Maintain records and prepare reports.
- Work courteously and tactfully with customers and employees.
- Establish and maintain cooperative and effective working relationships with others.
- Adapt to new technologies and policy changes.

### SUPERVISORY RESPONSIBILITIES:

Works under general supervision. No formal supervisory responsibilities but may oversee or direct the work of support staff, contractors, and/or volunteers.

### JOB CONDITIONS:

This position takes place in a typical office environment. The position may require long periods of sitting, standing, stooping, and/or reaching. This position may also require lifting objects weighing more than twenty-five (25) pounds. Specific vision abilities required by this position include close vision and the ability to adjust focus.

This position may be subject to verbal abuse at times from the public.



# City of Stevenson Personnel Policy

**MINIMUM QUALIFICATIONS:**

- High School Graduate or GED equivalent.
- Office Experience, good writing skills, understanding of basic accounting
- 10-key by touch, computer experience (preferably Windows based) excel & word
- Good Customer Service

**PREFERRED QUALIFICATIONS:**

- Prior Government Experience with land use permitting, zoning, building and construction permitting
- College graduate (AA degree or above)

**POSSESSION OR ABILITY TO ACQUIRE WITHIN 18 MONTHS OF EMPLOYMENT:**

- First Aid & CPR Certification
- Notary Public Designation
- Building Permit Technician Certification

This job description does not constitute an agreement between the employer and the employee and in no way implies that these are the only duties to be performed. Employees occupying the position will be required to follow any other job-related instructions and to perform any other job-related duties requested by their supervisor.

**I have read and understood the functions, responsibilities and requirements of this position.**

\_\_\_\_\_  
Signature

\_\_\_\_\_  
Date



# City of Stevenson Personnel Policy

## PUBLIC WORKS FIELD SUPERVISOR

**POSITION:** Public Works Field Supervisor  
**REPORTS TO:** Public Works Director  
**EFFECTIVE DATE:** June 21, 2018  
**FLSA STATUS:** Non-Exempt

### SUMMARY:

This is a field position reporting directly to the Public Works Director. The Public Works Field Supervisor supervises and works with the Public Works employees responsible for the City's water and sewer utilities, streets, equipment, parks and general facilities. This position plans, assigns and schedules proper use of personnel and equipment to address the reoccurring public works tasks. The Public Works Field Supervisor must have the ability to troubleshoot and analyze problems related to street obstructions, slides, storm water system failures, sewage problems, equipment failures and water main breaks.

### ESSENTIAL JOB DUTIES:

The specific statements shown for each task are not intended to be all inclusive. They represent minimal essential elements and criteria considered necessary to successfully perform the job. Other related duties and responsibilities may be required or assigned, as needed.

- Schedules and performs the regular and recurring installation, repair and maintenance work in the streets, storm water system, water supply and distribution, sewer collection, parks division and City buildings.
- Proficiently operates and maintains departmental equipment such as back hoes, small bulldozers, street sweepers, dump trucks and loaders, power lawnmowers and concrete cutting equipment.
- Repairs water mains, cleans out and install sewer and water lines, clean curbs, gutters and repair park facilities.
- Operates and maintains the water treatment plant, well and intake stations.
- Prepares and maintains records and performs appropriate tests to meet State requirements and inspects new connections.
- Must be capable of operating the sewer treatment plant and able to conduct weekend testing and emergency back up to the Waste Water Treatment Plant operator.
- Organizes the water and sewer utilities on-call duties shared with other Public Works employees.
- Will assist with the preparation of bid specifications on public works projects.
- Responsible for the construction and maintenance of city parks, city buildings and other structures – carpentry skills will be needed.

### ABILITY TO:

- Oversee, direct and coordinate the work of lower level staff.



## City of Stevenson Personnel Policy

- Train staff in the most current and accepted practices in Public Works.
- Select, supervise, train and evaluate staff.
- Participate in the development and administration of goals, objectives and procedures.
- Protect the health and safety of personnel, the public, and the environment.
- Operate a variety of hand tools, machinery, vehicles and equipment.
- Communicate clearly and concisely both orally and in writing.
- Recognize, prioritize and accomplish needed tasks.
- Perform routine maintenance and housekeeping work.
- Interpret, analyze and apply new technical information.
- Perform moderately, strenuous physical tasks.
- Read utility as-built drawings for water and sewer, use maps, understand basic survey descriptions and work with engineering documents.
- Compose utility as-built drawings for water and sewer.
- Establish and maintain cooperative and effective working relationships with others.
- Work independently with little direction.
- Analyze problems, identify alternative solutions, project consequences of proposed actions and implement recommendations in Public Works.
- Observe health and safety regulations.
- Maintain records and prepare reports.
- Work courteously and tactfully with customers and employees.

### SUPERVISORY RESPONSIBILITIES:

Responsible for supervising Public Works staff, with direction from the Public Works Director.

### JOB CONDITIONS:

Outdoor work environment, subject to adverse and extreme weather conditions.

Climbing ladders; standing for extended periods of time; walking to perform weed control; lifting and carrying heavy object; pulling hoists; kneeling; crouching; bending; dexterity of hands and fingers to operate hand and power tools.

Exposure to chlorine and methane gas, sewage; sewage vapors; working around and with machinery having moving parts; working at heights on ladders and structures.

Operation of the water and sewer utilities will require some weekend duties as part of the on-call rotation shared with the Public Works field crew. These duties may be extended to a full week rotation in emergency situations. Emergencies will require overtime work to repair utilities.

This position may be subject to verbal abuse at times from the public.

### MINIMUM QUALIFICATIONS:





## City of Stevenson Personnel Policy

High School graduate or GED equivalent.  
Must live within a thirty-minute response time of the city.  
Must be able to work independently and have work experience in general maintenance, trade areas.  
Must have a valid state issued Driver's License with CDL validation or ability to acquire within six (6) months. The City will complete a review of the final applicant's driving record.  
Must be highly skilled in heavy equipment operation and maintenance.  
Work is performed out-of-doors requiring average physical agility, dexterity and endurance.

### PREFERRED QUALIFICATIONS:

Experience in Heavy Equipment Operation (backhoes, dump trucks, and snowplows).  
Plumbing and Carpentry Skills.  
Basic electrical skills, telemetry and cable splicing knowledge.  
Experience in Welding.  
Basic mechanical skills and diesel and gas equipment repair.  
Experience in Road Construction and Repair.  
Knowledge of Grounds Maintenance and/or Irrigation Experience.  
Supervisory skills and good oral communication capabilities to work with the public

### POSSESSION OR ABILITY TO ACQUIRE WITHIN 18 MONTHS OF EMPLOYMENT:

Completion of "competent person training" in the areas of trenching, shoring and confined spaces.  
Water Distribution Manager I (WDM I)  
Cross Connection Control Specialist (CCCS)  
Water Plant Operator I (WTPO I)  
Wastewater Treatment Plant Operator I (WTPO I)  
A/C Pipe Certification  
Flagger Certification  
First Aid & CPR Certification

### POSSESSION OR ABILITY TO ACQUIRE WITHIN 5 YEARS OF EMPLOYMENT

Water Plant Operator II (WTPOII)

This job description does not constitute an agreement between the employer and the employee and in no way implies that these are the only duties to be performed. Employees occupying the position will be required to follow any other job-related instructions and to perform any other job-related duties requested by their supervisor.

**I have read and understood the functions, responsibilities and requirements of this position.**



# City of Stevenson Personnel Policy

Signature \_\_\_\_\_

Date \_\_\_\_\_

## UTILITIES/MAINTENANCE WORKER

**POSITION:** Utilities/Maintenance Worker  
**REPORTS TO:** Public Works Field Supervisor  
**EFFECTIVE DATE:** June 21, 2018  
**FLSA STATUS:** Non-Exempt

### SUMMARY:

This is a field position responsible to the Public Works Field Supervisor and the Public Works Director. The position will work in the City’s utility (water and sewer), street, parks, equipment, and general facilities maintenance departments.

### ESSENTIAL JOB DUTIES:

The specific statements shown for each task are not intended to be all inclusive. They represent minimal essential elements and criteria considered necessary to successfully perform the job. Other related duties and responsibilities may be required or assigned, as needed.

- Performs the regular and recurring installation, repair and maintenance work in the streets, water supply and distribution, sewer collection or parks division.
- Proficiently operates departmental equipment such as back hoe’s, small bulldozers, street sweepers, dump trucks and loaders, power lawnmowers and concrete cutting equipment.
- Repairs water mains, cleans out and installs sewer and water lines, cleans curbs, gutters and repairs park facilities.
- Responds to complaints from the public on utility and infrastructure items, such as water leaks, pressure issues, loss of water, potholes, etc. and evaluates the situation to explain to the supervisor for possible direction on a resolution.
- Reads city water meters on a regular basis.
- Assists in or shuts off utility lines and mains to repair broken sections of water or sewer lines and shut-offs for delinquent utility accounts.
- Operates and maintains the water treatment plant, well and intake stations.
- Prepares and maintains records and performs appropriate tests to meet State requirements.
- Responsible for installation, maintenance and repair of city sewer lines and pumping equipment.
- Weekend testing and emergency back up to the Waste Water Treatment Plant operator.
- Maintenance of city streets will include pothole patching, striping, snow plowing, sign repair, litter control, hot mixing, and control of vegetation along right-of-way.
- Operation of street sweeper and brushcutters.
- Street light repair.



## City of Stevenson Personnel Policy

- Culvert replacement, chip seal, painting crosswalks, concrete cutting saw, pouring sidewalks, operating cutting torch, saws, roller, man lift, jumping jack.
- Maintenance of fire hydrants.
- Responsible for the general maintenance and repair of both diesel and gas engines.
- Responsible for the construction and maintenance of city parks, city buildings and other structures.

### ABILITY TO:

- Follow oral and written directions.
- Protect the health and safety of personnel, the public, and the environment.
- Operate a variety of hand tools, machinery, vehicles and equipment.
- Communicate clearly and concisely both orally and in writing.
- Recognize, prioritize and accomplish needed tasks.
- Perform routine maintenance and housekeeping work.
- Interpret, analyze and apply new technical information.
- Perform moderately, strenuous physical tasks.
- Read utility as-built drawings for water and sewer, use maps, understand basic survey descriptions and work with engineering documents.
- Establish and maintain cooperative and effective working relationships with others.
- Work independently with little direction.
- Determine appropriate action within clearly defined guidelines.
- Observe health and safety regulations.
- Maintain records and prepare reports.
- Work courteously and tactfully with customers and employees.

### SUPERVISORY RESPONSIBILITIES:

There are no supervision responsibilities associated with this position.

### JOB CONDITIONS:

Outdoor work environment, subject to adverse and extreme weather conditions.

Climbing ladders; standing for extended periods of time; walking to perform weed control; lifting and carrying heavy object; pulling hoists; kneeling; crouching; bending; dexterity of hands and fingers to operate hand and power tools.

Exposure to chlorine and methane gas, sewage; sewage vapors; working around and with machinery having moving parts; working at heights on ladders and structures.

Operation of the water and sewer utilities will require some weekend duties as part of the on-call rotation shared with the Public Works field crew. These duties may be extended to a full week rotation in emergency situations. Emergencies will require overtime work to repair utilities.



## City of Stevenson Personnel Policy

This position may be subject to verbal abuse at times from the public.

### MINIMUM QUALIFICATIONS:

High School graduate or GED equivalent.

Must live within a thirty-minute response time of the city.

Must be able to work independently.

Must have a valid state issued Driver's License with commercial validation or the ability to acquire within six (6) months. The City will complete a review of the final applicant's driving record.

### PREFERRED QUALIFICATIONS:

Experience in Heavy Equipment Operation (backhoes, dump trucks, and snowplows).

Plumbing Skills.

Basic Electrical Skills including basic Telemetry and cable splicing knowledge.

Carpentry Skills.

Experience in Welding.

Diesel and Gas equipment repair.

Basic Mechanical Skills.

Experience in Road Construction and Repair.

Knowledge of Grounds Maintenance.

### POSSESSION OR ABILITY TO ACQUIRE WITHIN 18 MONTHS OF EMPLOYMENT:

Completion of "competent person training" in the areas of trenching, shoring and confined spaces.

Water Distribution Manager I (WDM I)

Cross Connection Control Specialist (CCCS)

Water Plant Operator I (WTPO I)

Wastewater Treatment Plant Operator I (WWTPO I)

A/C Pipe Certification

Flagger Certification

First Aid & CPR Certification

### POSSESSION OR ABILITY TO ACQUIRE WITHIN 5 YEARS OF EMPLOYMENT

Water Plant Operator II (WTPO II)

This job description does not constitute an agreement between the employer and the employee and in no way implies that these are the only duties to be performed. Employees occupying the position will be required to follow any other job-related instructions and to perform any other job-related duties requested by their supervisor.

**I have read and understood the functions, responsibilities and requirements of this position.**



# City of Stevenson Personnel Policy

---

Signature

---

Date



# City of Stevenson Personnel Policy

## FACILITIES MAINTENANCE WORKER

**POSITION:** Facilities Maintenance Worker  
**REPORTS TO:** Public Works Field Supervisor  
**EFFECTIVE DATE:** January 1, 2020  
**FLSA STATUS:** Non-Exempt

### SUMMARY:

This is a field position responsible to the Public Works Field Supervisor and the Public Works Director. The position will work in the City's utility (water and sewer), street, parks, equipment, and general facilities maintenance departments and other partner agencies as agreed upon by the City.

### ESSENTIAL JOB DUTIES:

The specific statements shown for each task are not intended to be all inclusive. They represent minimal essential elements and criteria considered necessary to successfully perform the job. Other related duties and responsibilities may be required or assigned, as needed.

- Performs the regular and recurring maintenance work in the parks department and with partner agencies to include mowing, edging, fertilizing and spraying.
- Routinely removes brush and debris from fence lines.
- Proficiently operates departmental equipment such as trucks, pressure washers, lawnmowers, weed eaters and other brush cutting equipment.
- Cleans and maintains curbs and gutters..
- Collection and disposal of garbage from City or partner owned waste receptacles.
- Set-up and clean-up of special events.
- Cleans, maintains, and repairs park facilities.
- May assist City or partner personnel on other projects.

### ABILITY TO:

- Follow oral and written directions.
- Protect the health and safety of personnel, the public, and the environment.
- Operate a variety of hand tools, machinery, vehicles and equipment.
- Communicate clearly and concisely both orally and in writing.
- Recognize, prioritize and accomplish needed tasks.
- Perform routine maintenance and housekeeping work.
- Interpret, analyze and apply new technical information.
- Perform moderately, strenuous physical tasks.
- Establish and maintain cooperative and effective working relationships with others.
- Work independently with little direction.
- Determine appropriate action within clearly defined guidelines.
- Observe health and safety regulations.
- Work courteously and tactfully with customers and employees.





# City of Stevenson Personnel Policy

## SUPERVISORY RESPONSIBILITIES:

There are no supervision responsibilities associated with this position.

## JOB CONDITIONS:

Outdoor work environment, subject to adverse and extreme weather conditions.

Climbing ladders; standing for extended periods of time; walking to perform weed control; lifting and carrying heavy objects; pulling hoists; kneeling; crouching; bending; dexterity of hands and fingers to operate hand and power tools.

Exposure to chlorine and methane gas, sewage; sewage vapors; working around and with machinery having moving parts; working at heights on ladders and structures.

This position may be subject to verbal abuse at times from the public.

## MINIMUM QUALIFICATIONS:

High School graduate or GED equivalent.

Must be able to work independently.

Must have a Driver’s License with commercial validation or the ability to acquire within six (6) months. The City will complete a review of the final applicant’s driving record.

## PREFERRED QUALIFICATIONS:

Experience in small power equipment operation (lawn mowers, weed eaters, saws, etc).

Basic Mechanical Skills.

Knowledge of Grounds Maintenance.

Good oral and written communication skills are necessary to work with the public.

## POSSESSION OR ABILITY TO ACQUIRE WITHIN 18 MONTHS OF EMPLOYMENT:

Completion of “competent person training” in the areas of trenching, shoring and confined spaces.

Flagger Certification

First Aid & CPR Certification

This job description does not constitute an agreement between the employer and the employee and in no way implies that these are the only duties to be performed. Employees occupying the position will be required to follow any other job-related instructions and to perform any other job-related duties requested by their supervisor.

**I have read and understood the functions, responsibilities and requirements of this position.**

\_\_\_\_\_  
Signature

\_\_\_\_\_  
Date



## City of Stevenson Personnel Policy

### WASTEWATER TREATMENT PLANT OPERATOR I

**POSITION:** Wastewater Treatment Plant Operator I  
**REPORTS TO:** Public Works Field Supervisor  
**EFFECTIVE DATE:** March 15, 2018  
**FLSA STATUS:** Non-Exempt

#### SUMMARY:

This is a field position working in the City's wastewater department mostly at the treatment plant. Some time may be spent in other departments when assistance is needed during special projects or emergencies.

#### ESSENTIAL JOB DUTIES:

The specific statements shown for each task are not intended to be all inclusive. They represent minimal essential elements and criteria considered necessary to successfully perform the job. Other related duties and responsibilities may be required or assigned, as needed.

- ~~Makes sure that all work is performed~~ Perform all work to safety standards and ensure that no property or person is at risk.
- Perform Operation and Maintenance activities within the general areas of wastewater treatment plant, sewer collection system, sewer lift stations and other public facilities as needed.
- Monitor, test, adjust and maintain the wastewater treatment plant in working order.
- Make periodic rounds to check the general operations of the plant; unplug and clean pumps; remove debris; check operation of pumps.
- Take and record plant operation readings according to prescribed schedules.
- Collect samples for lab analysis; perform lab analysis as required.
- Inspection and data collection from customers for use in the Industrial Permitting process.
- Perform wash down of chambers and clarifiers on a regular schedule.
- Maintain and operate lift stations and wells.
- Maintain daily logs; report unsafe conditions; record plant operating data as required.
- Provide yard maintenance in watering, mowing and weeding grounds.
- Maintain building in clean and sanitary condition; wash floors and walls; perform light maintenance.
- Week end testing and emergency back up to the Waste Water Treatment Plant operator.
- Operates and maintains equipment which may include city trucks, backhoes, jackhammers, mowers, snow plows, compactors, cutting torches and welders. Reports deficiencies for repair to ensure safe and efficient operation.
- Assists with the general maintenance and repair of both diesel and gas engines.



## City of Stevenson Personnel Policy

### ABILITY TO:

- Operate and maintain the Wastewater Treatment Plant and assure Plant processes are in compliance with local, State and federal discharge limits and the NPDES Permit.
- Protect the health and safety of personnel, the public, and the environment.
- Operate a variety of hand tools, machinery, vehicles and equipment.
- Communicate technical information clearly and concisely both orally and in writing.
- Maintain accurate log readings and operating information.
- Recognize and respond quickly to operational information.
- Perform plant maintenance and housekeeping work.
- Interpret, analyze and apply new technical information.
- Perform moderately, strenuous physical tasks.
- Read utility as-built drawings for water and sewer, use maps, understand basic survey descriptions and work with engineering documents.
- Establish and maintain cooperative and effective working relationships with others.
- Work independently with little direction.
- Determine appropriate action within clearly defined guidelines.
- Observe health and safety regulations.
- Maintain records and prepare reports.
- Work courteously and tactfully with customers and employees.

### SUPERVISORY RESPONSIBILITIES:

There are no supervision responsibilities associated with this position.

### JOB CONDITIONS:

Outdoor work environment, subject to adverse and extreme weather conditions.

Climbing ladders; standing for extended periods of time; walking to perform weed control; lifting and carrying heavy object; pulling hoists; kneeling; crouching; bending; dexterity of hands and fingers to operate hand and power tools.

Exposure to chlorine and methane gas, sewage; sewage vapors; working around and with machinery having moving parts; working at heights on ladders and structures.

Operation of the water and sewer utilities will require some weekend duties as part of the on-call rotation shared with the Public Works field crew. These duties may be extended to a full week rotation in emergency situations. Emergencies will require overtime work to repair utilities.

### MINIMUM QUALIFICATIONS:

High School graduate or GED equivalent.

Must live within a thirty-minute response time of the city.

Must be able to work independently.

Must have a valid state issued Driver's License. The City will complete a review of the final applicant's driving record.



# City of Stevenson Personnel Policy

## PREFERRED QUALIFICATIONS:

- Experience in Heavy Equipment Operation (backhoes, dump trucks, and snowplows).
- Plumbing Skills.
- Basic Electrical Skills including basic Telemetry and cable splicing knowledge.
- Carpentry Skills.
- Experience in Welding.
- Diesel and Gas equipment repair.
- Basic Mechanical Skills.
- Knowledge of Grounds Maintenance.
- [Cross Connection Control Specialist](#)

## POSSESSION OR ABILITY TO ACQUIRE WITHIN 18 MONTHS OF EMPLOYMENT:

- Completion of “competent person training” in the areas of trenching, shoring and confined spaces.
- First Aid & CPR Certification
- Flagger Certification
- Water Plant Operator I (WTPO I)
- Water Distribution Manager I (WDM I)
- Wastewater Treatment Plant Operator I (WWTPO I)

This job description does not constitute an agreement between the employer and the employee and in no way implies that these are the only duties to be performed. Employees occupying the position will be required to follow any other job-related instructions and to perform any other job-related duties requested by their supervisor.

**I have read and understood the functions, responsibilities and requirements of this position.**

\_\_\_\_\_  
Signature

\_\_\_\_\_  
Date



## City of Stevenson Personnel Policy

### WASTEWATER TREATMENT PLANT OPERATOR II

**POSITION:** Wastewater Treatment Plant Operator II  
**REPORTS TO:** Public Works Field Supervisor  
**EFFECTIVE DATE:** March 15, 2018  
**FLSA STATUS:** Non-Exempt

#### SUMMARY:

This is a field position working in the City's wastewater department mostly at the treatment plant with some time spent in an office environment. Some time may be spent in other departments when assistance is needed during special projects or emergencies.

#### ESSENTIAL JOB DUTIES:

The specific statements shown for each task are not intended to be all inclusive. They represent minimal essential elements and criteria considered necessary to successfully perform the job. Other related duties and responsibilities may be required or assigned, as needed.

- ~~Makes sure that all work is performed~~ Perform all work to safety standards and ensure that no property or person is at risk.
- Perform Operation and Maintenance activities within the general areas of wastewater treatment plant, sewer collection system, sewer lift stations and other public facilities as needed.
- Monitor, test, adjust and maintain the wastewater treatment plant in working order.
- Make periodic rounds to check the general operations of the plant; unplug and clean pumps; remove debris; check operation of pumps.
- Take and record plant operation readings according to prescribed schedules.
- Collect samples for lab analysis; perform lab analysis as required.
- Manage and enforce ordinances, codes, and engineering standards related to wastewater and sewer management, including but not limited to Title 13. ~~Inspection~~ Inspect and ~~data collection~~ collect data from customers ~~for use in the Industrial Permitting processes~~ as required.
- Develop, implement, manage, and enforce industrial and commercial connection monitoring programs, including but not limited FOG and SIU programs.
- Perform wash down of chambers and clarifiers on a regular schedule.
- Maintain and operate lift stations and wells.
- Maintain daily logs; report unsafe conditions; record plant operating data as required.
- Provide yard maintenance in watering, mowing and weeding grounds.
- Maintain building in clean and sanitary condition; wash floors and walls; perform light maintenance.
- Week end testing and emergency back up to the Waste Water Treatment Plant operator.
- Operates and maintains equipment which may include city trucks, backhoes, jackhammers, mowers, snow plows, compactors, cutting torches and welders. Reports deficiencies for repair to ensure safe and efficient operation.



## City of Stevenson Personnel Policy

- Assists with the general maintenance and repair of both diesel and gas engines.

### ABILITY TO:

- Operate and maintain the Wastewater Treatment Plant and assure Plant processes are in compliance with local, State and federal discharge limits and the NPDES Permit.
- Protect the health and safety of personnel, the public, and the environment.
- Operate a variety of hand tools, machinery, vehicles and equipment.
- Communicate technical information clearly and concisely both orally and in writing.
- Maintain accurate log readings and operating information.
- Recognize and respond quickly to operational information.
- Perform plant maintenance and housekeeping work.
- Interpret, analyze and apply new technical information.
- Perform moderately, strenuous physical tasks.
- Read utility as-built drawings for water and sewer, use maps, understand basic survey descriptions and work with engineering documents.
- Establish and maintain cooperative and effective working relationships with others.
- Work independently with little direction or supervision.
- Determine appropriate action within clearly defined guidelines.
- Observe health and safety regulations.
- Maintain records and prepare reports.
- Work courteously and tactfully with customers and employees.

### SUPERVISORY RESPONSIBILITIES:

There are no supervision responsibilities associated with this position.

### JOB CONDITIONS:

Outdoor work environment, subject to adverse and extreme weather conditions.

Climbing ladders; standing for extended periods of time; walking to perform weed control; lifting and carrying heavy object; pulling hoists; kneeling; crouching; bending; dexterity of hands and fingers to operate hand and power tools.

Exposure to chlorine and methane gas, sewage; sewage vapors; working around and with machinery having moving parts; working at heights on ladders and structures.

Operation of the water and sewer utilities will require some weekend duties as part of the on-call rotation shared with the Public Works field crew. These duties may be extended to a full week rotation in emergency situations. Emergencies will require overtime work to repair utilities.

### MINIMUM QUALIFICATIONS:





## City of Stevenson Personnel Policy

High School graduate or GED equivalent.

Must live within a thirty-minute response time of the city.

Must be able to work independently.

Must have a valid state issued Driver's License. The City will complete a review of the final applicant's driving record.

Wastewater Treatment Plant Operator II (WWTPO II)

~~Water Distribution Manager I (WDM I)~~

### PREFERRED QUALIFICATIONS:

Experience in Heavy Equipment Operation (backhoes, dump trucks, and snowplows).

Plumbing Skills.

Basic Electrical Skills including basic Telemetry and cable splicing knowledge.

Carpentry Skills.

Experience in Welding.

Diesel and Gas equipment repair.

Basic Mechanical Skills.

Knowledge of Grounds Maintenance.

Cross Connection Control Specialist

Wastewater Treatment Plant Operator III (WWTPO III)

### POSSESSION OR ABILITY TO ACQUIRE WITHIN 18 MONTHS OF EMPLOYMENT:

Completion of "competent person training" in the areas of trenching, shoring and confined spaces.

First Aid & CPR Certification

Flagger Certification

Water Plant Operator I (WTPO I)

~~Water Distribution Manager I (WDM I)~~

This job description does not constitute an agreement between the employer and the employee and in no way implies that these are the only duties to be performed. Employees occupying the position will be required to follow any other job-related instructions and to perform any other job-related duties requested by their supervisor.

**I have read and understood the functions, responsibilities and requirements of this position**

\_\_\_\_\_  
Signature

\_\_\_\_\_  
Date



## City of Stevenson Personnel Policy

### WASTEWATER TREATMENT PLANT OPERATOR III

**POSITION:** Wastewater Treatment Plant Operator III  
**REPORTS TO:** Public Works Director  
**EFFECTIVE DATE:** March 15, 2018  
**FLSA STATUS:** Non-Exempt

#### SUMMARY:

This is a field position working in the City's wastewater department mostly at the treatment plant with some time spent in an office environment. Some time may be spent in other departments when assistance is needed during special projects or emergencies.

#### ESSENTIAL JOB DUTIES:

The specific statements shown for each task are not intended to be all inclusive. They represent minimal essential elements and criteria considered necessary to successfully perform the job. Other related duties and responsibilities may be required or assigned, as needed.

- ~~Makes sure that all work is performed~~ Perform all work to safety standards and ensure that no property or person is at risk.
- Perform Operation and Maintenance activities within the general areas of wastewater treatment plant, sewer collection system, sewer lift stations and other public facilities as needed.
- Monitor, test, adjust and maintain the wastewater treatment plant in working order.
- Make periodic rounds to check the general operations of the plant; unplug and clean pumps; remove debris; check operation of pumps.
- Take and record plant operation readings according to prescribed schedules.
- Collect samples for lab analysis; perform lab analysis as required.
- Inspection and data collection from customers for use in the Industrial Permitting process.
- Maintain and operate lift stations and wells.
- Maintain daily logs; report unsafe conditions; record plant operating data as required.
- Identifies and diagnoses operational problems, discusses scope and attributes of problems with staff and management, and recommends alterations, adjustments, and procedural changes to correct problems and maintain system stability.
- Acts as the treatment plant Onsite Operator and coordinates the activities of lower level operations staff; responds to operational incidents, and takes command when appropriate
- Uses a variety of standard testing procedures to determine problems and any adjustments needed in the treatment process.
- Maintain building and grounds in a clean and sanitary condition; wash floors and walls; clear weeds; perform light maintenance.
- Operates and maintains equipment which may include city trucks, backhoes, jackhammers, mowers, snow plows, compactors, cutting torches and welders. Reports deficiencies for repair to ensure safe and efficient operation.



## City of Stevenson Personnel Policy

- Assists with the general maintenance and repair of both diesel and gas engines.

### ABILITY TO:

- Operate and maintain the Wastewater Treatment Plant and assure Plant processes are in compliance with local, State and federal discharge limits and the NPDES Permit.
- Protect the health and safety of personnel, the public, and the environment.
- Operate a variety of hand tools, machinery, vehicles and equipment.
- Communicate technical information clearly and concisely both orally and in writing.
- Maintain accurate log readings and operating information.
- Recognize and respond quickly to operational information.
- Perform plant maintenance and housekeeping work.
- Interpret, analyze and apply new technical information.
- Perform moderately, strenuous physical tasks.
- Read utility as-built drawings for water and sewer, use maps, understand basic survey descriptions and work with engineering documents.
- Establish and maintain cooperative and effective working relationships with others.
- Work independently with little direction or supervision.
- Determine appropriate action within clearly defined guidelines.
- Observe health and safety regulations.
- Maintain records and prepare reports.
- Work courteously and tactfully with customers and employees.

### SUPERVISORY RESPONSIBILITIES:

This is a supervisory position directly overseeing city workers and contractors in the Wastewater department. Supervisory responsibilities include providing daily work direction, approval of absences and overtime, making recommendations regarding hiring, and completing performance evaluations.

### JOB CONDITIONS:

Outdoor work environment, subject to adverse and extreme weather conditions.

Climbing ladders; standing for extended periods of time; walking to perform weed control; lifting and carrying heavy object; pulling hoists; kneeling; crouching; bending; dexterity of hands and fingers to operate hand and power tools.

Exposure to chlorine and methane gas, sewage; sewage vapors; working around and with machinery having moving parts; working at heights on ladders and structures.

Operation of the water and sewer utilities will require some weekend duties as part of the on-call rotation shared with the Public Works field crew. These duties may be extended to a full week rotation in emergency situations. Emergencies will require overtime work to repair utilities.



# City of Stevenson Personnel Policy

## MINIMUM QUALIFICATIONS:

- High School graduate or GED equivalent.
- Must live within a thirty-minute response time of the city.
- Must be able to work independently.
- Must have a valid state issued Driver’s License. The City will complete a review of the final applicant’s driving record.
- Wastewater Treatment Plant Operator III (WWTPO III)
- ~~Water Distribution Manager I (WDM I)~~

## PREFERRED QUALIFICATIONS:

- Experience in Heavy Equipment Operation (backhoes, dump trucks, and snowplows).
- Plumbing Skills.
- Basic Electrical Skills including basic Telemetry and cable splicing knowledge.
- Carpentry Skills.
- Experience in Welding.
- Diesel and Gas equipment repair.
- Basic Mechanical Skills.
- Knowledge of Grounds Maintenance.
- Cross Connection Control Specialist
- Wastewater Treatment Plant Operator IV (WWTPO IV)

## POSSESSION OR ABILITY TO ACQUIRE WITHIN 18 MONTHS OF EMPLOYMENT:

- Completion of “competent person training” in the areas of trenching, shoring and confined spaces.
- First Aid & CPR Certification
- Flagger Certification
- Water Plant Operator I (WTPO I)
- Water Distribution Manager I (WDM I)

This job description does not constitute an agreement between the employer and the employee and in no way implies that these are the only duties to be performed. Employees occupying the position will be required to follow any other job-related instructions and to perform any other job-related duties requested by their supervisor.

**I have read and understood the functions, responsibilities and requirements of this position**

\_\_\_\_\_  
Signature

\_\_\_\_\_  
Date



# City of Stevenson Personnel Policy

## MINUTE TAKER

**POSITION:** Minute Taker  
**REPORTS TO:** City Administrator  
**EFFECTIVE DATE:** June 21, 2018  
**FLSA STATUS:** Non-Exempt

### SUMMARY:

Attends meetings and records minutes. Prepares final drafts of minutes off-site on applicant's personal computer equipment for the City Council, the Planning Commission and the boards of Adjustment and Appeals.

### ESSENTIAL JOB DUTIES:

The specific statements shown for each task are not intended to be all inclusive. They represent minimal essential elements and criteria considered necessary to successfully perform the job. Other related duties and responsibilities may be required or assigned, as needed.

- Attend and take minutes at regular meetings of the City Council and Planning Commission, special meetings as requested, and scheduled meetings of the Board of Adjustment and Board of Appeals and takes minutes of the proceedings.
- Prepare drafts of the minutes and submits those drafts for review by the designated staff member and final adoption by the appropriate elected or appointed board. All drafts are prepared using software compatible with that used by the City.

### ABILITY TO:

- Follow oral and written directions.
- Work independently with little direction.
- Communicate clearly in writing.

### SUPERVISORY RESPONSIBILITIES:

There are no supervision responsibilities associated with this position.

### JOB CONDITIONS:

The position may require long periods of sitting at evening meetings.

### MINIMUM QUALIFICATIONS

High School Graduate or GED equivalent  
Office experience with a minimum 50 wpm keyboard speed  
Familiarity with Windows based software  
Good writing and spelling skills

### PREFERRED QUALIFICATIONS:

Prior experience with boards and/or governing bodies



## City of Stevenson Personnel Policy

This job description does not constitute an agreement between the employer and the employee and in no way implies that these are the only duties to be performed. Employees occupying the position will be required to follow any other job-related instructions and to perform any other job-related duties requested by their supervisor.

**I have read and understood the functions, responsibilities and requirements of this position.**

\_\_\_\_\_  
Signature

\_\_\_\_\_  
Date





# City of Stevenson Personnel Policy

## Appendix # A-9

### CITY OF STEVENSON INTERNET/INTRANET, PERSONAL COMPUTER, VOICE MAIL AND E-MAIL USE POLICY

#### Section 1 - Purpose

This policy shall govern access to and use of City of Stevenson equipment, telecommunications, and services for employees of the City. The intent of this policy is to provide employees the tools to perform their job tasks without infringing on the rights of others, whether they are public or employee users of the personal computers, computer network, voice mail and Internet/Intranet communications systems. This includes minimizing the risk of computer virus infections, avoiding bandwidth congestion, adhering to software license agreements, and controlling private use of government equipment. This policy addresses issues such as acceptable conduct and usage procedures by public employees when using equipment provided by the employer or provider of such services.

Network and Internet access is provided to city employees as a research and communication tool to assist in conducting City business. Employees are trusted to use good judgment in use of City owned equipment, services (both duration and frequency of use), information technology or other resources.

#### Section 2 - Affected Parties

All City employees including appointed and elected officials, quasi-employees and authorized volunteers who use City equipment, services, and information technology must comply with this policy. All users are expected to use equipment and services in a professional manner.

#### Section 3 - References

The intent of this policy is to address the following Federal and State regulations as they relate to the use of telecommunication equipment and services:

:

- The Electronics Communications Privacy Act (ECPA)
- RCW 9.73.030 Privacy Act
- RCW 40.14 Retention, Storage and Destruction of Public Records.
- RCW 42.17 Open Public Records Act
- RCW 42.30 Open Meetings Act

#### Section 4 – Definitions

Terms used for the purposes of this policy --

- 4.1 Discoverable:  
Knowledge that something such as a letter, memo, note or Email or voice mail, may exist and can be requested to be produced as part of an investigation.
- 4.2 Downloading.  
Copying software programs and/or files from a floppy disk, CD ROM disk, or an INTERNET site or from another outside source, on to a City owned computer.
- 4.3 Email:  
Refer to all Electronic Mail software applications, whether INTERNET, LAN or WAN.
- 4.4 Employee:  
Employee means an elected official, officer, employee, quasi-employee, authorized volunteer of the City, who has been elected or appointed, but does not include an independent contractor.



## City of Stevenson Personnel Policy

- 4.5 INTERNET.  
Refers to connectivity with other agencies, networks and/or services.
- 4.6 Official City Business Purposes:  
Those activities performed by an official, employee, or quasi-employee or authorized volunteer of the City, as directed by the City through his/her supervisor in order to accomplish City programs or as required by the duties of his/her position or office.
- 4.7 Posted:  
Refers to World Wide Web (WWW) sites, Email, Voice Mail, news groups or any other network location where information is shared internally or externally.
- 4.8. Public Records:  
Those documents defined in RCW 42.17.020, including the exemptions listed in RCW 42.17.310 and 42.17.315.
- 4.9 Voice Mail:  
Recorded telephone messaging system.
- 4.10 WWW.  
Refers to World Wide Web sites.

### Section 5 - Policies

#### 5.1 City Business Purposes

Use of City computers, network resources (whether LAN, WAN, Internet or Electronic Mail) and voice mail systems, shall be used for City business purposes only, as is the case with all forms of City equipment and resources, except as provided below.

##### 5.1.1 Personal Use of City Computer Equipment

Personal use of City computer equipment may be allowed under the following conditions:

The use is small scale and only done during the employees break time or before or after normal business hours of the employee's department or as an alternate means of contact with family members for scheduling changes and other needs typically allowed under the telephone policy.

The employee has made a detailed and specific request and received prior approval through their supervisor and Department Head/Elected Official for the specific use.

The use will have no impact on other departments, employees, or the public and will not cause network congestion and/or misuse of system resources.

All provisions of this policy regarding inappropriate message content (Section 5.3.4 & 5.4.4), solicitations (Section 5.5), advertising (Section 5.6), campaigning (Section 5.7), public records, and other applicable policies will govern the personal use of City equipment by an employee. Employee shall abide by all policies of appropriate behavior and usage discussed in this policy.

Expenses that would be charged to any member of the public which are incurred due to the use, will be paid to the City. These may include:

Photocopy Machines - same rate charged to the public.

Computers - Reimburse the City for any supplies used (i.e. diskettes, paper for printing) at the rate the department would charge to the public.

Facsimiles Machine - Reimburse for pages sent at same rate charged to public. Employees MAY NOT use FAX machines to send messages to a long distance telephone number unless the call is



# City of Stevenson Personnel Policy

charged to the employee's telephone credit card. Reimburse for pages received to cover cost of supplies.

## 5.2 Computer Viruses

When there is a clear business reason for downloading software and/or files from outside sources, the appropriate anti-virus detection program(s) will be used to prevent infection. Use of the Internet risks exposure to viruses that can cause serious problems if downloaded from the Internet.

## 5.3 Electronic Mail (Email)

### 5.3.1 Disclosure

Electronic Mail (Email is NOT private and may be subject to the Public Disclosure Act, RCW 42.17).

All Email messages, (whether created or received) may be considered "public records" pursuant to the Public Disclosure Act, "if they relate to the conduct of government or the performance of any governmental or proprietary function." Subject to certain exceptions, the public has a right to examine most "public records." If Email is used, the user is responsible to comply with the Public Disclosure Act.

Email shall not be used to send confidential information. Email is not an appropriate form of communication with legal counsel when seeking legal advice or transmitting information concerning matters in litigation or disputes which are likely to result in litigation. Inadvertent disclosure or dissemination of the communication could waive the attorney-client privilege.

5.3.2 Requests for Copies of Electronic Mail (Email) Information Request for Email messages, calendars, or records will be treated like any other "public record" in the possession of the City. Email contents may be subject to subpoena in legal matters. The department and/or user cannot destroy or erase "public records" except as allowed in RCW Chapter 40.14. Deleting Email messages from a computer does not guarantee it has been erased from the system. Employees should use good judgment when creating Email and always assume that it is discoverable. The City reserves the right to retrieve and/or review Email messages to monitor or prevent misuse of the system, to measure employee responsiveness, or during the investigations of improper or illegal activities.

### 5.3.3 Retention of Electronic Mail (Email)

Each user is responsible to maintain "public records" as required by law. Messages that may be needed beyond 30 days or that are considered "public records", shall be copied or moved to another storage location. Email messages that contain information that could be considered "public records" under RCW Chapter 42.17, must be printed and included in the subject file, or be retained as word processing documents, by the employee controlling the message.

### 5.3.4 Inappropriate Electronic Mail (Email) Message Content

City network users will refrain from the posting of any materials, which violate federal or State laws and/or City Personnel Policies and/or resolutions. All issues raised in the city's Personnel Policy are applicable. These shall include, but are not limited to, those that constitute; discrimination, sexual, racial, religious harassment, slander and/or defamation towards any individual, corporation, agency or organization and disparagement of any trade or product. City employees shall refrain from any posting or transmittal of materials containing obscene, pornographic or profane materials of any kind, including jokes, cartoons, photographs or any other text based or digitized images. Generally, the same policies of appropriate behavior apply in network usage, as apply in the workplace.

## 5.4 Voice Mail (If Applicable)

### 5.4.1 Disclosure

Voice Mail messages are NOT private. All voice mail messages, (whether created or received) may be considered to be "public records" pursuant to the Public Disclosure Act, RCW 42.17, "if they relate to the



# City of Stevenson Personnel Policy

conduct of government or the performance of any governmental or proprietary function." Subject to certain exceptions, the public has a right to examine "public records." If Voice Mail is used, the user is responsible to comply with the Public Disclosure Act.

Voice mail shall not be used to send confidential information. Voice mail is not an appropriate form of communication with legal counsel when seeking legal advice or transmitting information concerning matters in litigation or disputes which are likely to result in litigation. Inadvertent disclosure or dissemination of the communication could waive the attorney-client privilege.

## 5.4.2 Requests for Copies of Voice Mail Information

Request for voice mail messages or records will be treated like any other "public record" in the possession of the City. Voice mail contents may be subject to subpoena in legal matters. The department and/or user cannot destroy or erase "public records" except as allowed in RCW Chapter 40.14. Deleting voice mail messages from the telephone system does not guarantee it has been erased. Employees should use good judgment when creating voice mail messages and always assume that it is discoverable. The City reserves the right to retrieve and/or review voice mail messages to monitor or prevent misuse of the system, to measure employee responsiveness, or during the investigations of improper or illegal activities.

## 5.4.3 Retention of Voice Mail Messages

Each user is responsible to maintain "public records" as required by law. Any messages that may be needed shall be copied or moved to another storage location. Voice mail messages that contain information that could be considered "public records" under RCW Chapter 42.17, shall be saved to a computer disk and retained as a word processing document.

## 5.4.4 Inappropriate Voice Mail Message Content

City voice mail users will refrain from leaving messages which violate federal or State laws and/or City Personnel Policies and/or resolutions. These shall include but not be limited to those that constitute; discrimination, sexual, racial, religious harassment, slander and/or defamation towards any individual, corporation, agency or organization and disparagement of any trade or product. City employees shall refrain from leaving any message containing obscene, pornographic or profane information of any kind including jokes. Generally, the same policies of appropriate behavior apply in voice mail usage, as apply in the workplace.

## **5.5 Solicitations**

Employees shall refrain from any type of postings, whether on a Web site, to a news group, via Email, or Voice Mail which constitutes a solicitation of any type (i.e. religious, political, personal gain, or in support of illegal activities.)

## **5.6 Advertising**

Employees shall refrain from any type of postings, whether on a Web site, to a news group, via Email or Voice Mail, which may enter the realm of commercial advertising. When government supplies legislative or other public interest information on the Internet, there is little danger of advertising liability arising from the posting.

## **5.7 Campaigning**

Employees must make certain that information provided about elected officials does not cross the line into campaign advertising. LAN, WAN, Internet and telephone system access are established with taxpayer money and there is a risk of violation of laws when elected officials become the centerpiece of information.

## **5.8 Personal Security**



# City of Stevenson Personnel Policy

Employees should keep personal log-ons and passwords confidential and change passwords on a regular basis as needed. Failure to adhere to this policy jeopardizes network security and puts users at risk of potential misuse of the system by other individuals. Network users may be held responsible for all actions taken using their personal network access permissions.

## **5.9 Limitations on Entry into the City Computer Network**

### 5.9.1 Access to Internet and/or Email Services

Access to Internet and/or Email Services will be coordinated through the City Administrator. This includes the use of independent dial-up Internet Service Providers (ISP's) and dial-up Email services.

### 5.9.2 Access to Information on the City's Computer Network

Access to information contained on the City's computer network shall be based on a need to know and a determination from the appropriate department head.

### 5.9.3 Access to Information on Personal Computer Hard Drives

Information stored on the hard drive of a computer may contain discloseable information, it may contain exempt information, it may contain NON-GOVERNMENTAL information, and it may also contain personal information of the person who is assigned the computer for his or her use (similar to the contents of a desk drawer). Therefore, access to or operation of City computers by persons who are not employees, quasi-employees, authorized volunteers or contractors of the City should not be permitted due to the inability to segregate the information.

### 5.9.4 Data Sharing By and Between Employees

In general City employees may have access into such network-stored data in various departments and servers as are relevant to their jobs. If granted, such access should be coupled with an admonition that the material obtained might be exempt from public inspection and caution should be exercised in order to not violate the rights of privacy of private citizens or create a liability for the disclosure of exempt information and a violation of privacy.

### 5.9.5 Access Levels

Levels of access by executive and management employees should be determined by employment status and the need to know.

All users must submit a completed Internet Usage Agreement to their department head who will assign access levels.

## **5.10 World Wide Web**

### 5.10.1 Internet Access

Permission for employees to access the World Wide Web (WWW) resources will be dependent on approval from elected officials or department heads.

#### 5.10.1.1 Internet Access Audit Logs

The Department Head may revoke permission to access specific sites. Access times may be restricted due to bandwidth congestion and/or misuse of system resources.

### 5.10.2 News Groups

When posting to news groups, City employees will use a disclaimer, such as - "these opinions are mine and not necessarily those of the City". Users shall abide by all other policies of appropriate behavior and usage discussed in this policy.

## **5.11 Copyrights, Trademarks, Patents and Authorship**

### 5.11.1 Conservative and Cautious Approach to Copyrights, etc.



# City of Stevenson Personnel Policy

City employees should take a conservative and cautious approach when dealing with materials that may be copyrighted. In general, if an employee is not sure if materials are copyrighted, they should not be used without permission in writing from the author.

The City will comply with Federal software licensing and copyright law.

Copies are to be made with the copyright holder's permission.

Unauthorized copying of software will be cause for disciplinary action. The City will not defend employees for willful misuse of copyrighted software.

Employee owned software must be accompanied by a valid license as evidence of ownership.

## 5.11.2 Trademarks, Patents and Authorship

Trademark violations can occur when governments publish materials online, and knowingly or unknowingly attach to a publication, or omit from the publication, a registered trademark. Employees publishing materials online will respect trademarks and obtain the appropriate authorizations before publishing the materials.

## **5.12 Public Meetings Regulations Open**

RCW 42.30 addresses regulations concerning public and private meetings. Email or voice mail initiated by a Council person and directed to any other Council person, relating to the conduct of City government, is subject to the Open Public Meetings Act. The City should therefore be cautious in the use of Email and voice mail communication in order to not violate these regulations.

## **5.13 Public Disclosure of Electronic Data and Voice Mail, RCW 42.17**

### 5.13.1 Email (electronic communication from one computer to another or to others) and Voice Mail

Each person and department using Email or voice mail should be familiar with the Public Disclosure Act and the definition of "public records."

When information is initiated by a City employee it is NOT SUBJECT TO DISCLOSURE if

- (i) it is of a private nature (non-governmental); or
- (ii) it is within the exemptions from public inspection.

Otherwise, it is subject to public inspection at reasonable times, but not by computer operation by other than City employees or contractors. Preferably, disclosure should be provided by printed document; if by diskette or visual examination of screen, care must be exercised to delete exempt data from disclosure.

### 5.13.2 Other Data

The same rules of disclosure apply to Email and voice mail as to written or printed information. The public's right to inspect and copy remains the same. Because of financial restraints and to protect public records from destruction, requesters of public records should not have access to electronic information. Instead, a City representative should print out a hard copy of the requested information. The public should not be permitted to operate City computers for three reasons:

- 1) Data could be inadvertently erased or destroyed;
- 2) Certain excepted or exempt documents, including personal or confidential material, could inadvertently be disclosed; and



## City of Stevenson Personnel Policy

- 3) Limited resources do not allow us to provide the equipment necessary to permit citizens' access to this information.

### Section 6 - Procedures:

#### 6.1 Enforcement of This Policy (Right to Administer or Revoke Use).

Failure of City employees to adhere to this policy may result in restriction or revocation of access and/or disciplinary action. The City Administrator, Mayor or their designee may access data under an employee's control without the consent of the individual employee when necessary for normal business functions or when the Administrator becomes aware of possible inappropriate Internet use.

The Administrator will investigate the site(s) and/or system(s) and call upon the user to determine how the site is business related. If the Administrator concludes that the site is inappropriate the offense will be logged in the individual's file and a memo forwarded to the employee detailing the offense and potential consequences.

##### 6.1.1 Access Limitation or Revocation

With concurrence of the Mayor, City Administrator or Department Head, employees who are found to have violated this Policy may be subject to the following:

- 1) Internet and Email access may be revoked.
- 2) Access times may be restricted.
- 3) Disciplinary action.

##### 6.1.2 Disciplinary Action

Substantial or repeated abuse of the provisions outlined in this policy may be deemed sufficient justification for immediate discharge.

### Section 7 - Responsibilities:

#### 7.1 Compliance with City Policies

All Department Supervisors, Department Heads and Elected Officials are responsible for ensuring compliance with federal laws and regulations, RCW'S, WAC'S, City Ordinances, resolutions and policies. Employees (excluding Elected Officials) may be disciplined in accordance to the City Personnel Policy and/or applicable union contract for failure to follow this Policy.





# City of Stevenson Personnel Policy

## Internet Policy Waiver Form & Authorization to Use

I, \_\_\_\_\_,  
have read and understand the City Computer Network, Internet, Intranet, E-mail and Voice Mail Use Policy.

I understand and agree to follow this policy which includes:

Network resources, whether LAN, WAN, Internet, Electronic Mail or Voice Mail systems should be used for official City business purposes only, as is the case with all forms City of equipment and resources. Personal use of the City equipment discussed in this policy is allowed only as described in Section 5. 1. 1.

Electronic Mail (Email) from an internal system and/or the Internet, is NOT private. All Email messages, (whether created or received) may be considered to be public records pursuant to the Public Disclosure Act, RCW Ch. 42.17, and the public has a right to examine most public records.

The City will maintain and monitor Internet access. Permission to access Internet or specific Internet sites may be revoked by a department head and at times internet access may be restricted due to bandwidth congestion and/or misuse of system resources.

I have read and understand this policy and will abide by its provisions.

Signed: \_\_\_\_\_

Date: \_\_\_\_\_



# City of Stevenson Personnel Policy

## Appendix # A-10

### CITY OF STEVENSON AUTHORIZING THE USE OF CREDIT CARDS

#### 1) Retail Gasoline Credit Cards

- A. Credit cards may be used for the purchase of gasoline and other minor automotive supplies for City vehicles. Cash advances, purchases of food or other non-automotive related items are not authorized.
- B. No single transaction will exceed \$500.00 unless authorized by the Mayor or City Administrator.
- C. The City Administrator shall be responsible for establishing all credit arrangements and agreements with applicable vendors and managing the use of credit cards by City employees and elected or appointed officials.
  - I. Except when being used by an employee, elected or appointed official to make an authorized transaction, credit cards shall remain in the possession of the City Administrator or his/her designee.
  - II. Any department head, elected or appointed official, or other authorized employee requesting to use a credit card shall make a request to the City Administrator and shall sign for receipt and return of the card. A copy of the receipt for all purchases shall be submitted to the City Administrator when the card is returned.
    - (i) An employee whose job responsibilities would be facilitated by the use of a credit card will be assigned a gas credit card to be used in the day to day operations of the Public Works Department.
  - III. The vendor which carries the account shall be required to submit a bill for the credit card to the City monthly. All charges will be reviewed by the accountable Department Head before being routed to the Accounts Payable Department.
  - IV. The City Administrator may disallow the use of any City credit card by a City employee or official for a violation or misuse of this policy.

#### 1 All Other Credit Cards

- A. The City of Stevenson shall contract with an appropriate banking facility for one VISA credit card account with a limit of \$5,000.00. The City may establish credit arrangements with other vendors from time to time. The City Administrator shall set individual credit limits on each account as they are established, not to exceed \$5,000.00 per account.
- B. Credit cards may be used by City employees, and by the elected or appointed officials, for advance payment of expenses associated with authorized travel such as registration and tuition fees, lodging expenses and transportation expenses,



## City of Stevenson Personnel Policy

Credit cards may also be used for official government purchases and acquisitions, including supplies, small tools and equipment, capital equipment approved by budget or authorization of the Council, unless the law requires the City to purchase such equipment by bid process.

- C. Credit cards shall not be used for cash advances. If requested, funds for City business travel may be provided to employees and elected or appointed officials from the Travel Advance Account.
- D. The City Administrator shall be responsible for managing the use of credit cards by City employees and city officials
  - I. Except when being used by an employee or elected or appointed official to make an authorized transaction, credit cards shall remain in the possession of the City administrator or designee.
  - II. Any department head, elected or appointed official, or other authorized employee requesting to use a City VISA or other credit card shall make a request to the City Administrator and shall sign for receipt and return of the card.
  - III. The financial institute or vendor that carries the account shall be required to submit a bill for use of credit cards to the City monthly. All charges will be reviewed by the accountable Department Head before being routed to the Accounts Payable Department.
  - IV. Elected or appointed officials and employees of the City of Stevenson who use the credit cards are required to comply in all respects with the provisions of RCW 42.24.115 regarding the submission of a fully itemized travel expense voucher and a repayment of disallowed charges.
  - V. The City Administrator may disallow the use of any City credit card by a City employee or official for violation of this policy.



# City of Stevenson Personnel Policy

## Appendix # A-11

### Reasonable Suspicion Documentation Form

Employee Name: \_\_\_\_\_  
 Observation Date: \_\_\_\_\_ Location: \_\_\_\_\_  
 Start Time: \_\_\_\_\_ am/pm End Time: \_\_\_\_\_ am/pm

**APPEARANCE**

- Normal
- Flushed complexion
- Poor hygiene
- Unkempt clothing
- Bloodshot eyes
- Rapid eye movement
- Blank/glazed eyes
- Inability to focus eyes
- Eyes overly sensitive to light
- Frequent use of eye drops
- Trembling/shaking
- Drowsiness

**BEHAVIOR**

- Normal
- Poor balance
- Stumbling
- Swaying
- Staggering
- Unusual gait
- Using arms for balance
- Grabbing for support
- Flailing

**PERSONAL**

- Normal
- Moody/mood swings
- Depressed
- Overly excitable
- Loss of inhibitions
- Risk taking
- Unwarranted confidence

**SPEECH**

- Normal
- Slurred
- Loud
- Incoherent
- Rapid/excessive talk
- Confused/hard to follow
- Exaggerated pronunciation
- Inappropriate laughter
- Whispering
- Non-responsive/silent

**PERFORMANCE INDICATORS**

- Normal
- Poor manual dexterity
- Work errors
- Excessive time off task
- Absent from work station
- Inability to follow directions
- Inattentive
- Customer complaints
- Co-worker complaints

**PHYSICAL**

- Normal
- Complaints of dizziness
- Flu-like symptoms
- Chills
- Low energy
- Bursts of high/low energy

**INTERPERSONAL**

- Normal
- Arguing
- Fighting
- Defensive
- Hostile
- Overly aggressive

**BODY ODORS**

- Normal
- Odor of alcohol on breath
- Body odor of alcohol
- Smell of marijuana on breath or clothes
- Excessive perspiration
- Frequent use of mouthwash breath mints or spray

**AWARENESS**

- Disoriented
- Sleepy
- Stupor
- Suspicious
- Blaming
- Paranoia

Other observed actions or behavior: \_\_\_\_\_

*To the best of my knowledge and belief, this report represents the appearance, behavior, and/or conduct of the above-named employee, observed by me and upon which I base my decision to require said employee to submit to reasonable suspicion drug and/or alcohol testing.*

\_\_\_\_\_  
Supervisor Signature

\_\_\_\_\_  
Date



# City of Stevenson Personnel Policy

Appendix # A-12

## Post-Accident Checklist

Employee Name: \_\_\_\_\_  
 Date/Time Accident Occurred: \_\_\_\_\_  
 Documenting Personnel: \_\_\_\_\_

### Is the employee required to test under DOT?

➤ Circle YES or NO and follow the chart...

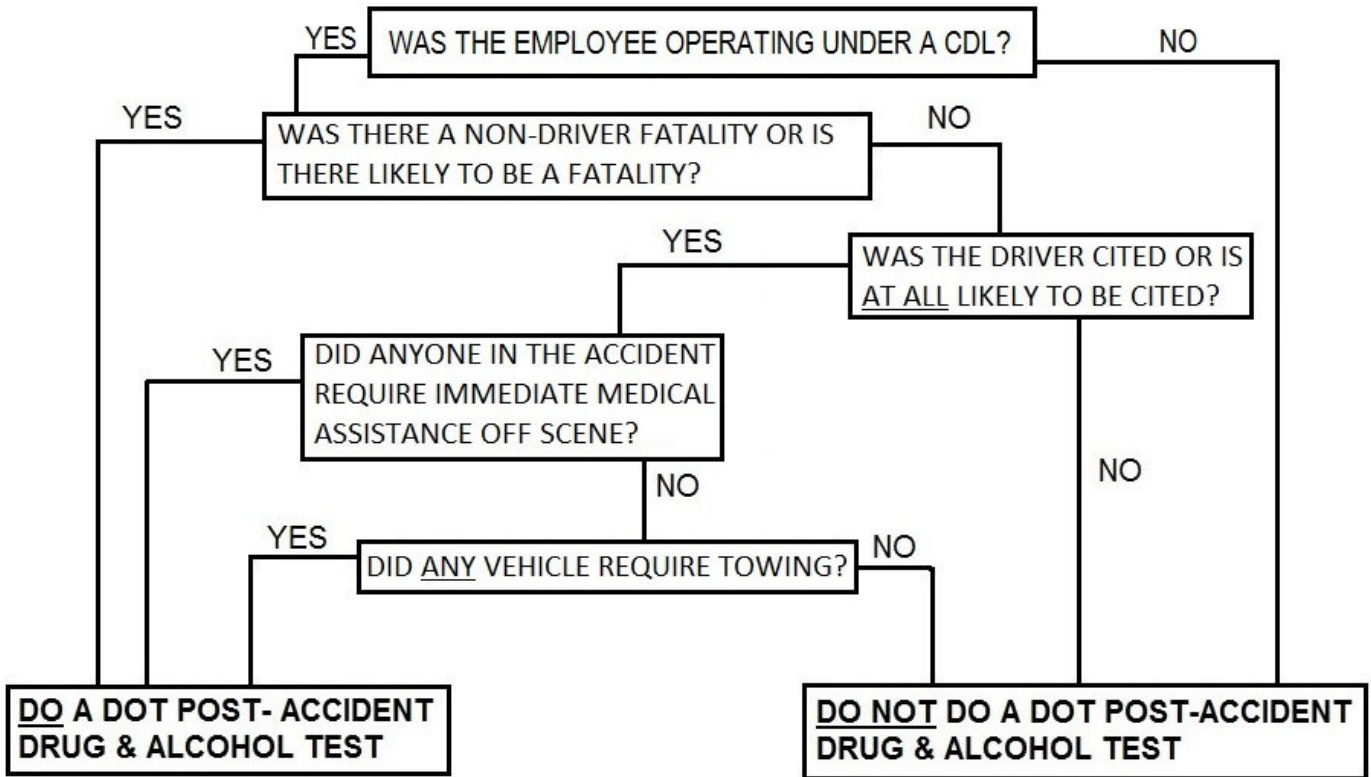

*Additional Comments:*

---



---



---



---

If the employee is NOT required to test under DOT, what does your **company policy** state... *Do they need to test as a NON-DOT?*

★ **DOT REGULATION TIME LIMITS:**  
**CONTROLLED SUBSTANCES:** Employee must test within **32 HOURS** of the accident.  
**ALCOHOL:** Employee must test within **8 HOURS** of the accident.  
 (If the alcohol test is not administered within the first 2 hours, document why.)



# City of Stevenson Personnel Policy

## Appendix # A-13

### Consent for Limited Queries of the FMCSA Drug and Alcohol Clearinghouse

I, \_\_\_\_\_, hereby provide consent to the City of Stevenson,  
 Employee Name  
 hereinafter referred to as the Company and QCL, Inc. as the C/TPA, to conduct a limited query of the FMCSA Commercial Driver’s License Drug and Alcohol Clearinghouse (Clearinghouse) to determine whether drug or alcohol violation information about me exists in the Clearinghouse. I consent to multiple limited queries, to be conducted for the duration of my employment with the Company; and understand that the number of limited queries is unlimited.

I understand that if the limited query conducted by the Company indicates that drug or alcohol violation information about me exists in the Clearinghouse, FMCSA will not disclose that information to the Company without first obtaining additional specific consent from me. The company will obtain the driver’s electronic consent in the Clearinghouse prior to the release of detailed violation information when a full query is warranted.

I further understand that if I refuse to provide consent for the Company to conduct a limited query of the Clearinghouse, the Company must prohibit me from performing safety-sensitive functions, including driving a commercial motor vehicle, as required by FMCSA’s drug and alcohol program regulations.

\_\_\_\_\_  
 Employee Signature

\_\_\_\_\_  
 Date



# City of Stevenson Personnel Policy

## Appendix # A-14

### Driver Evaluation Matrix

The purpose of the Driver Evaluation Matrix is to determine eligibility for an employee when driving is a function of the job.

#### **ONCE ADR IS RECEIVED:**

1. Review the driver's Abstract of Driving Record (ADR) using the Driver Evaluation Matrix shown below.
2. Determine whether driving record is clear, acceptable, borderline or poor.

#### **THINGS TO KEEP IN MIND:**

1. Past driving records are highly predictive of future performance as a safe, dependable driver and statistically, there is a high correlation between recent driving history and future accident frequency. A driver, who had four moving violations, more than three years ago, may be a better risk than a driver who has two violations within the last 12 months. However, do not base any hiring, promotion, or transfer decisions solely on this one factor. Persons with borderline ADRs can be advised of their status and coached to improve.
2. Consider the applicability of the individual's past violations to the job the applicant or employee will perform.
3. Review the details of the violations listed on the ADR with the applicant/employee to determine if any extenuating circumstances exist regarding the violation.
4. Accidents listed on ADRs are coded with a two-digit number (e.g. 01-CAR, 02-CAR) that indicates the number of vehicles involved in the particular accident. This number is NOT an indication the driver was or was not at fault.
5. Most convictions and violations are kept on an ADR for five years from the date of conviction or adjudication. Departmental actions, such as, suspensions, revocations, or disqualifications are kept on an ADR for ten years from final release date. Certain violations appear on an ADR in perpetuity, such as alcohol-related convictions, vehicular assault and vehicular homicide convictions and deferred prosecutions.

Under Washington State law, employers are not allowed to consider violations that occurred more than ten years ago, unless the position involves law enforcement, school districts, or the direct responsibility for children, mentally ill, developmentally delayed, or vulnerable adults. Federal law imposes no similar date restriction but requires employers to take into account the age of the violation, the nature of the violation, and the relationship of the violation to the job.





## City of Stevenson Personnel Policy

*Authorized drivers should only be allowed to operate a vehicle on behalf of the City if their driving record demonstrates they will be a safe driver. Those possessing an invalid or suspended license are not eligible to operate a vehicle, for the City under any circumstances.*

Moving Violations	# of Accidents (at-fault)			
	0	1	2	3+
0	CLEAR	A	A	B
1	A	A	B	P
2	A	B	P	P
3+	B	P	P	P
Major	P	P	P	P

A = Acceptable: Those with none or fewer than three points.

B = Borderline: Management should give consideration prior to placing or maintaining this individual in a driving position and may want to provide additional training or other requirements.

P = Poor: Management should give serious consideration to not placing or maintaining this individual in a driving position.

Major Violations include:

- DUI – Driving under the influence of drugs or alcohol
- Negligent homicide in the use of a motor vehicle
- Using a motor vehicle for the commission of a felony
- Operating a vehicle without a valid unsuspended license
- Aggravated assault with a motor vehicle
- Grand theft of a motor vehicle
- Reckless driving or speed contest/racing
- Hit and run (bodily injury and/or property damage)

Moving Violations include violations other than Major Violations. These consist of speeding and other moving traffic infractions. See WAC 308-104-160. Traffic photo enforcement and parking tickets do not appear on driving records as Moving Violations. If multiple citations are issued on the same day, they will be counted as a single violation.



*Summer N. Scheyer*  
**SHERIFF**

OFFICE OF THE SKAMANIA COUNTY

# SHERIFF

PO Box 790  
200 Vancouver Ave.  
Stevenson WA 98648  
Phone (509)427-9490  
Fax (509)427-4369  
www.skamaniasheriff.com  
scso@co.skamania.wa.us

*Tracy Wyckoff*  
*Undersheriff*

*Jason Fritz*  
*Chief of Corrections*

*Steve Minnis*  
*Chief Civil Deputy*

February 2023

City Of Stevenson

**Service Hours**

**Patrol/Calls**

**386.25**

03/01/23  
06:42

Skamania County Sheriff's Office  
Law Total Incident Report, by Nature of Incident

Page: 5059  
1

Nature of Incident	Total Incidents
Abandon Vehicle Right of Way	1
Simple Assault	1
Burglary Residence Unlawful En	1
Business Establishment Alarm	12
Carprowl Theft from Auto	1
Child Abuse or Neglect	1
Citizen Dispute	2
Disorderly Conduct	2
Domestic Violence	7
Drug Referral	2
DUI Alcohol or Drugs	1
Found Animal	1
Fraud	1
Harrass	1
Hospice	1
Information Report	3
Intoxicated Person	1
Juvenile Problem	3
Lost Property	2
Medical Emergency	26
Mental Health Problems	4
Patrol Request	3
Possession Drug Paraphenalia	1
Poss Synthetic Cont. Substance	1
Public Nuisance/County Ordinan	2
Residential Alarm	1
Sex Offense/Abuse	1
Suspicious Person/Circumstance	6
Theft Other Property	1
Threats	2
Traffic Stop	17
Trespassing	3
Power/Gas/Water Problems	4
Vagrancy	1
Vandalism/Mailic Misch	2
Violation Court Orders	1
Vicious Animals	1
Wanted Person - Warrant	3
Welfare Check	4

-----  
Total Incidents for This Report: 128  
-----

Report includes:  
All dates between `00:00:00 02/01/23` and `00:00:00 03/01/23`  
All agencies matching `SCSO`  
All natures  
All locations matching `21`  
All responsible officers  
All dispositions  
All clearance codes  
All observed offenses  
All reported offenses  
All offense codes  
All circumstance codes  
-----

Steve

03/01/23  
07:21

Skamania County Sheriff's Office  
Incident Audit Report

5059  
Page: 1

Incident#	Nature of Incident	Offense Code	Loctn Code	Disposition
23-00826	Traffic Stop	TOFF	21	CLEARED DRIVER WARNING
23-00839	Traffic Stop	TOFF	21	Cleared Adlt Exception
23-00843	Traffic Stop	TOFF	21	CLEARED DRIVER WARNING
23-00844	Traffic Stop	TOFF	21	CLEARED DRIVER WARNING
23-00848	Traffic Stop	TOFF	21	CLEARED DRIVER WARNING
23-00860	Traffic Stop	TOFF	21	CLEARED DRIVER WARNING
23-00876	Traffic Stop	TOFF	21	CLEARED DRIVER WARNING
23-00896	Traffic Stop	TOFF	21	CLEARED DRIVER WARNING
23-00898	Traffic Stop	TOFF	21	CLEARED DRIVER WARNING
23-00918	Traffic Stop	TOFF	21	Investigation Complete
23-00920	Traffic Stop	TOFF	21	Investigation Complete
23-00979	Traffic Stop	TOFF	21	CLEARED DRIVER WARNING
23-00980	Traffic Stop	TOFF	21	CLEARED DRIVER WARNING
23-01045	Traffic Stop	TOFF	21	CLEARED DRIVER WARNING
23-01047	Traffic Stop	TOFF	21	CLEARED DRIVER WARNING
23-01126	Traffic Stop	TOFF	21	CLEARED DRIVER WARNING
23-01207	Traffic Stop	TOFF	21	CLEARED DRIVER WARNING

Total Incidents: 17

Report includes:

- All dates reported between `00:00:00 02/01/23` and `00:00:00 03/01/23`
- All agencies matching `SCSO`
- All nature of incidents matching `Traffic Stop`
- All offenses observed
- All offenses reported
- All offense codes
- All dispositions
- All responsible officers
- All locations matching `21`

\*\*\* End of Report /tmp/rptGKpw6H-rplwiar.r1\_3 \*\*\*

# TREASURER'S REPORT

## Fund Totals

City Of Stevenson

Time: 15:59:46 Date: 03/10/2023

02/01/2023 To: 02/28/2023

Page: 1

Fund	Previous Balance	Revenue	Expenditures	Ending Balance	Claims Clearing	Payroll Clearing	Outstanding Deposits	Adjusted Ending Balance
001 General Expense Fund	1,519,194.58	47,463.11	85,102.48	1,481,555.21	815.96	12,288.35	-29.02	1,494,630.50
010 General Reserve Fund	336,156.85	470.19		336,627.04	0.00	0.00	0.00	336,627.04
020 Fire Reserve Fund	1,655,596.10	3,401.91		1,658,998.01	0.00	0.00	0.00	1,658,998.01
030 ARPA	298,313.00	0.00		298,313.00	0.00	0.00	0.00	298,313.00
100 Street Fund	80,316.30	30,133.45	27,125.54	83,324.21	1,128.12	2,179.47	-48.05	86,583.75
103 Tourism Promo & Develop Fund	1,143,230.99	35,340.56	13,340.45	1,165,231.10	5,000.00	41.84	-3.21	1,170,269.73
105 Affordable Housing Fund	12,783.74	0.00		12,783.74	0.00	0.00	0.00	12,783.74
107 HEALing SCARS Fund	10,190.57	0.00		10,190.57	0.00	0.00	0.00	10,190.57
300 Capital Improvement Fund	210,894.39	2,653.10		213,547.49	0.00	0.00	0.00	213,547.49
312 Columbia Ave	0.00	0.00	7,804.37	-7,804.37	0.00	0.00	0.00	-7,804.37
400 Water/Sewer Fund	1,997,040.84	173,422.15	140,992.01	2,029,470.98	8,459.96	6,161.94	-1,175.61	2,042,917.27
406 Wastewater Short Lived Asset Res. Fund	65,337.00	0.00		65,337.00	0.00	0.00	0.00	65,337.00
408 Wastewater Debt Reserve Fund	61,191.00	0.00		61,191.00	0.00	0.00	0.00	61,191.00
410 Wastewater System Upgrades	-732,889.81	279,015.73	1,092,492.34	-1,546,366.42	66,279.96	0.00	0.00	-1,480,086.46
500 Equipment Service Fund	95,981.99	9,063.02	18,430.49	86,614.52	4,165.85	418.26	-22.15	91,176.48
630 Stevenson Municipal Court	0.00	238.50	238.50	0.00	0.00	0.00	0.00	0.00
	6,753,337.54	581,201.72	1,385,526.18	5,949,013.08	85,849.85	21,089.86	-1,278.04	6,054,674.75

# TREASURER'S REPORT

## Account Totals

City Of Stevenson

02/01/2023 To: 02/28/2023

Time: 15:59:46 Date: 03/10/2023

Page: 2

Cash Accounts		Beg Balance	Deposits	Withdrawals	Ending	Outstanding Rec	Outstanding Exp	Adj Balance
1	Checking	659,163.43	1,554,659.54	1,376,422.21	837,400.76	-1,052.15	106,939.71	943,288.32
10	Xpress Bill Pay	29,579.20	39,682.53	35,000.00	34,261.73	-225.89	0.00	34,035.84
11	Cash Drawer	100.00	0.00	0.00	100.00	0.00	0.00	100.00
12	Petty Cash	400.00	0.00	0.00	400.00	0.00	0.00	400.00
Total Cash:		689,242.63	1,594,342.07	1,411,422.21	872,162.49	-1,278.04	106,939.71	977,824.16
Investment Accounts		Beg Balance	Deposits	Withdrawals	Ending	Outstanding Rec	Outstanding Exp	Adj Balance
5	LGIP	4,148,630.36	12,755.68	1,000,000.00	3,161,386.04	0.00	0.00	3,161,386.04
6	US Bank Safekeeping	1,915,464.55	0.00	0.00	1,915,464.55	0.00	0.00	1,915,464.55
Total Investments:		6,064,094.91	12,755.68	1,000,000.00	5,076,850.59	0.00	0.00	5,076,850.59
		6,753,337.54	1,607,097.75	2,411,422.21	5,949,013.08	-1,278.04	106,939.71	6,054,674.75

TREASURER'S REPORT  
Fund Investments By Account

City Of Stevenson

Time: 15:59:46 Date: 03/10/2023  
Page: 3

02/01/2023 To: 02/28/2023

Fund Totals:	Previous Balance	Purchases	Interest	Total Investments	Liquidated	Ending Balance
001 000 General Expense Fund	974,828.93		2,997.28	2,997.28		977,826.21
010 000 General Reserve Fund	123,240.60		378.92	378.92		123,619.52
020 000 Fire Reserve Fund	1,017,375.10		3,128.10	3,128.10		1,020,503.20
100 000 Street Fund	22,113.00		67.99	67.99		22,180.99
103 000 Tourism Promo & Develop Fund	776,514.48		2,387.53	2,387.53		778,902.01
300 000 Capital Improvement Fund	175,090.88		538.35	538.35		175,629.23
400 000 Water/Sewer Fund	978,069.92	10,000.00	3,007.24	13,007.24		991,077.16
410 000 Wastewater System					1,000,000.00	-1,000,000.00
500 000 Equipment Service Fund	81,397.45		250.27	250.27	10,000.00	71,647.72
5 - LGIP	4,148,630.36	10,000.00	12,755.68	22,755.68	1,010,000.00	3,161,386.04
001 000 General Expense Fund	426,045.00					426,045.00
010 000 General Reserve Fund	211,908.38					211,908.38
020 000 Fire Reserve Fund	635,725.10					635,725.10
103 000 Tourism Promo & Develop Fund	320,417.69					320,417.69
300 000 Capital Improvement Fund	25,549.13					25,549.13
400 000 Water/Sewer Fund	285,600.57					285,600.57
500 000 Equipment Service Fund	10,218.68					10,218.68
6 - US Bank Safekeeping	1,915,464.55	0.00	0.00			1,915,464.55
	6,064,094.91	10,000.00	12,755.68	22,755.68	1,010,000.00	5,076,850.59



TREASURER'S REPORT

Fund Investment Totals

City Of Stevenson

02/01/2023 To: 02/28/2023

Time: 15:59:46 Date: 03/10/2023

Page: 4

Fund Totals:	Previous Balance	Purchases	Interest	Ttl Investments	Liquidated	Investment Bal	Available Cash
001 General Expense Fund	1,400,873.93		2,997.28	2,997.28		1,403,871.21	77,684.00
010 General Reserve Fund	335,148.98		378.92	378.92		335,527.90	1,099.14
020 Fire Reserve Fund	1,653,100.20		3,128.10	3,128.10		1,656,228.30	2,769.71
030 ARPA						0.00	298,313.00
100 Street Fund	22,113.00		67.99	67.99		22,180.99	61,143.22
103 Tourism Promo & Develop Fund	1,096,932.17		2,387.53	2,387.53		1,099,319.70	65,911.40
105 Affordable Housing Fund						0.00	12,783.74
107 HEALing SCARS Fund						0.00	10,190.57
300 Capital Improvement Fund	200,640.01		538.35	538.35		201,178.36	12,369.13
312 Columbia Ave						0.00	-7,804.37
400 Water/Sewer Fund	1,263,670.49	10,000.00	3,007.24	13,007.24		1,276,677.73	752,793.25
406 Wastewater Short Lived Asset Res. Fund						0.00	65,337.00
408 Wastewater Debt Reserve Fund						0.00	61,191.00
410 Wastewater System Upgrades					1,000,000.00	-1,000,000.00	-546,366.42
500 Equipment Service Fund	91,616.13		250.27	250.27	10,000.00	81,866.40	4,748.12
	<u>6,064,094.91</u>	<u>10,000.00</u>	<u>12,755.68</u>	<u>22,755.68</u>	<u>1,010,000.00</u>	<u>5,076,850.59</u>	<u>872,162.49</u>

Ending fund balance (Page 1) - Investment balance = Available cash.

5,949,013.08

# TREASURER'S REPORT

## Outstanding Vouchers

02/01/2023 To: 02/28/2023

As Of: 02/28/2023 Date: 03/10/2023

Time: 15:59:46 Page: 5

City Of Stevenson

Year	Trans#	Date	Type	Acct#	War#	Vendor	Amount	Memo
2023	484	02/27/2023	Util Pay	1		Xpress Billpay	565.17	Xpress Import - CC - 02-27-2023__daily_batch.csv
2023	486	02/28/2023	Tr Rec	1		Telephone Tax Vendor	8.63	January 2023 Ooma Inc
2023	487	02/28/2023	Tr Rec	1		Telephone Tax Vendor	1.99	January 2023 Broadvoice
2023	488	02/28/2023	Tr Rec	1		Gordon Rosander	319.38	February 2023 Distribution
2023	489	02/28/2023	Util Pay	1		Xpress Billpay	156.98	Xpress Import - CC - 02-28-2023__daily_batch.csv
Receipts Outstanding:							1,052.15	
2023	465	02/28/2023	Payroll	1	EFT	Colonial Life	110.97	Pay Cycle(s) 02/28/2023 To 02/28/2023 - Disability; Pay Cycle(s) 02/28/2023 To 02/28/2023 - Life Insurance
2023	468	02/28/2023	Payroll	1	EFT	HRA VEBA Trust Contributions	600.00	Pay Cycle(s) 02/28/2023 To 02/28/2023 - HRA VEBA
2023	466	02/28/2023	Payroll	1	EFT	Department of Retirement Systems	15,034.48	Pay Cycle(s) 02/28/2023 To 02/28/2023 - PERS2; Pay Cycle(s) 02/28/2023 To 02/28/2023 - DCP
2023	469	02/28/2023	Payroll	1	EFT	State of WA Dept of Social & Health Serv	829.30	Pay Cycle(s) 02/28/2023 To 02/28/2023 - WA Child Support
2021	3014	12/12/2021	Payroll	1	15591	Chelsey M Farris	134.83	2021 Volunteer FF Pay
2022	1564	06/30/2022	Payroll	1	16098	Michael D Johnson	137.86	PP 06.01.22-06.30.22
2022	2547	10/12/2022	Claims	1	16359	SCSD Swimming Pool	1,359.63	1079.0 - 330 NW GROPPER ROAD
2022	3065	12/08/2022	Payroll	1	16483	Pehr F Collins	225.33	2022 Volunteer FF Pay
2022	3076	12/08/2022	Payroll	1	16491	Adam M Johnston	138.52	2022 Volunteer FF Pay
2022	3319	12/31/2022	Claims	1	16584	Skamania Lawyer PLLC	635.00	December 2022 Statement
2022	3341	12/31/2022	Claims	1	16591	CGTA	5,000.00	2022 Regional Tourism Advancement
2022	3354	12/31/2022	Claims	1	16604	Mobley Engineering dba Lancaster Mobley	1,114.00	Stevenson City Wide Traffic Study
2023	335	02/16/2023	Claims	1	16665	Correct Equipment	231.56	T-Cal Plus
2023	349	02/16/2023	Claims	1	16679	Kimball Midwest	383.62	E/S Shop Supplies
2023	350	02/16/2023	Claims	1	16680	Kurt D. Krall	3,147.23	Tires for Carson's/Susan's/S-10's Trucks
2023	359	02/16/2023	Claims	1	16689	PacWest Machinery Inc	635.00	Brooms for Sweeper
2023	375	02/16/2023	Claims	1	16705	US Bank Safekeeping	30.00	January 2023 Safekeeping Fees
2023	378	02/16/2023	Claims	1	16708	Verizon Wireless	111.70	January 2023 Cell Phone Charges
2023	379	02/16/2023	Claims	1	16709	Wallis Engineering PLLC	66,279.96	2021 WW Collection Sys Upgrades; WWTP Improvements Bidding & Construction
2023	381	02/16/2023	Claims	1	16711	Wave Division Holdings LLC	286.15	February 2023 City Hall Internet; February 2023 Firehall Internet; February 2023 WWTP Services
2023	417	02/22/2023	Claims	1	16712	Astound Broadband	6,636.00	Internet Installation at Water Treatment Plant-Construction Costs
2023	440	02/28/2023	Payroll	1	16714	Tiffany H Andersen	2,939.77	PP 02.01.23-02.28-23
2023	450	02/28/2023	Payroll	1	16715	Michael D Johnson	275.30	PP 02.01.23-02.28-23

TREASURER'S REPORT

Outstanding Vouchers

02/01/2023 To: 02/28/2023

As Of: 02/28/2023 Date: 03/10/2023

Time: 15:59:46 Page: 6

City Of Stevenson

Year	Trans#	Date	Type	Acct#	War#	Vendor	Amount	Memo
2023	453	02/28/2023	Payroll	1	16716	Kristy A McCaskell	275.30	PP 02.01.23-02.28-23
2023	470	02/28/2023	Payroll	1	16717	City of Stevenson	319.38	Pay Cycle(s) 02/28/2023 To 02/28/2023 - City Payback
2023	471	02/28/2023	Payroll	1	16718	WGAP Washington Gorge Action Program	68.82	Pay Cycle(s) 02/28/2023 To 02/28/2023 - Food Bank
							106,939.71	
2023	485	02/27/2023	Util Pay	10		Xpress Billpay	157.00	Xpress Import - iPay - 02-27-2023__daily_batch.csv
2023	490	02/28/2023	Util Pay	10		Xpress Billpay	18.52	Xpress Import - EFT - 02-28-2023__daily_batch.csv
2023	491	02/28/2023	Util Pay	10		Xpress Billpay	50.37	Xpress Import - CheckFree - 02-28-2023__daily_batch.csv
							225.89	Receipts Outstanding:
							106,939.71	

Fund	Claims	Payroll	Total
001 General Expense Fund	815.96	12,288.35	13,104.31
100 Street Fund	1,128.12	2,179.47	3,307.59
103 Tourism Promo & Develop Fund	5,000.00	41.84	5,041.84
400 Water/Sewer Fund	8,459.96	6,161.94	14,621.90
410 Wastewater System Upgrades	66,279.96	0.00	66,279.96
500 Equipment Service Fund	4,165.85	418.26	4,584.11
	85,849.85	21,089.86	106,939.71

TREASURER'S REPORT

Signature Page

City Of Stevenson

02/01/2023 To: 02/28/2023

Time: 15:59:46 Date: 03/10/2023

Page: 7

---

We the undersigned officers for the City of Stevenson have reviewed the foregoing report and acknowledge that to the best of our knowledge this report is accurate and true:

Signed: \_\_\_\_\_ Signed: \_\_\_\_\_  
City Administrator / Date Deputy Clerk-Treasurer / Date

## 2023 BUDGET POSITION

City Of Stevenson

Time: 16:00:19 Date: 03/10/2023

Page: 1

001 General Expense Fund Months: 01 To: 02

Revenues	Amt Budgeted	Revenues	Remaining	
100 Unreserved	1,457,189.47	1,457,189.47	0.00	100.0%
102 Unemployment Reserve	33,413.82	33,413.82	0.00	100.0%
104 Custodial Reserve	51,135.13	51,135.13	0.00	100.0%
<b>308 Beginning Balances</b>	<b>1,541,738.42</b>	<b>1,541,738.42</b>	<b>0.00</b>	<b>100.0%</b>
311 Property Tax	546,401.90	7,573.80	538,828.10	1.4%
313 Sales Tax	328,000.00	64,527.18	263,472.82	19.7%
316 Utility Tax	32,000.00	27,490.83	4,509.17	85.9%
317 Other Tax	16,000.00	8,114.19	7,885.81	50.7%
<b>310 Taxes</b>	<b>922,401.90</b>	<b>107,706.00</b>	<b>814,695.90</b>	<b>11.7%</b>
321 Licenses	2,900.00	897.50	2,002.50	30.9%
322 Permits	0.00	10.00	(10.00)	0.0%
<b>320 Licenses &amp; Permits</b>	<b>2,900.00</b>	<b>907.50</b>	<b>1,992.50</b>	<b>31.3%</b>
000	19,800.00	0.00	19,800.00	0.0%
330 Grants	52,000.00	0.00	52,000.00	0.0%
335 State Shared	11,000.00	0.00	11,000.00	0.0%
336 State Entitlements, Impact Payments & Taxe	18,653.42	4,103.46	14,549.96	22.0%
<b>330 Intergovernmental Revenues</b>	<b>101,453.42</b>	<b>4,103.46</b>	<b>97,349.96</b>	<b>4.0%</b>
341 Admin, Printing & Probation Fees	280,014.81	379.81	279,635.00	0.1%
342 Fire District 2	32,700.00	8,428.09	24,271.91	25.8%
345 Planning	4,500.00	1,940.00	2,560.00	43.1%
376 Parks	0.00	0.00	0.00	0.0%
<b>340 Charges For Goods &amp; Services</b>	<b>317,214.81</b>	<b>10,747.90</b>	<b>306,466.91</b>	<b>3.4%</b>
350 Fines & Penalties	12,700.00	1,041.26	11,658.74	8.2%
360 Interest & Other Earnings	8,000.00	6,737.39	1,262.61	84.2%
<b>Fund Revenues:</b>	<b>2,906,408.55</b>	<b>1,672,981.93</b>	<b>1,233,426.62</b>	<b>57.6%</b>
Expenditures	Amt Budgeted	Expenditures	Remaining	
511 Legislative	37,000.00	2,973.06	34,026.94	8.0%
512 Judicial	60,510.00	7,830.24	52,679.76	12.9%
513 Executive	147,076.60	22,188.96	124,887.64	15.1%
514 Financial, Recording & Elections	137,200.54	26,514.06	110,686.48	19.3%
515 Legal Services	16,500.00	1,530.00	14,970.00	9.3%
517 Employee Benefit Programs	10,525.00	0.00	10,525.00	0.0%
518 Centralized Services	176,723.32	47,678.51	129,044.81	27.0%
521 Law Enforcement	228,846.03	35,280.62	193,565.41	15.4%
202 Fire Department	105,207.50	10,695.49	94,512.01	10.2%
203 Fire District 2	30,750.00	729.49	30,020.51	2.4%
<b>522 Fire Control</b>	<b>135,957.50</b>	<b>11,424.98</b>	<b>124,532.52</b>	<b>8.4%</b>
528 Dispatch Services	6,000.00	3,229.71	2,770.29	53.8%
551 Public Housing Services	0.00	0.00	0.00	0.0%
553 Conservation	500.00	0.00	500.00	0.0%
550 Building	15,000.00	66.00	14,934.00	0.4%
560 Planning	284,855.00	24,003.65	260,851.35	8.8%

2023 BUDGET POSITION

City Of Stevenson

Time: 16:00:19 Date: 03/10/2023

Page: 2

001 General Expense Fund Months: 01 To: 02

Expenditures	Amt Budgeted	Expenditures	Remaining	
<b>558 Planning &amp; Community Devel</b>				
570 Economic Development	27,685.00	0.00	27,685.00	0.0%
<b>558 Planning &amp; Community Devel</b>	<b>327,540.00</b>	<b>24,069.65</b>	<b>303,470.35</b>	<b>7.3%</b>
562 Public Health	10,000.00	0.00	10,000.00	0.0%
565 Welfare	10,000.00	0.00	10,000.00	0.0%
566 Substance Abuse	150.00	51.37	98.63	34.2%
573 Cultural & Community Activities	500.00	0.00	500.00	0.0%
576 Park Facilities	57,700.00	9,654.54	48,045.46	16.7%
580 Non Expenditures	0.00	(998.98)	998.98	0.0%
597 Interfund Transfers	175,000.00	0.00	175,000.00	0.0%
100 Unreserved	1,284,130.43	0.00	1,284,130.43	0.0%
102 Unemployment Reserve	33,414.00	0.00	33,414.00	0.0%
104 Custodial Reserve	51,135.13	0.00	51,135.13	0.0%
<b>999 Ending Balance</b>	<b>1,368,679.56</b>	<b>0.00</b>	<b>1,368,679.56</b>	<b>0.0%</b>
<b>Fund Expenditures:</b>	<b>2,906,408.55</b>	<b>191,426.72</b>	<b>2,714,981.83</b>	<b>6.6%</b>
<b>Fund Excess/(Deficit):</b>	<b>0.00</b>	<b>1,481,555.21</b>		

## 2023 BUDGET POSITION

City Of Stevenson

Time: 16:00:19 Date: 03/10/2023

Page: 3

010 General Reserve Fund Months: 01 To: 02

Revenues	Amt Budgeted	Revenues	Remaining	
308 Beginning Balances	335,258.75	335,258.75	0.00	100.0%
360 Interest & Other Earnings	0.00	1,368.29	(1,368.29)	0.0%
<b>Fund Revenues:</b>	<b>335,258.75</b>	<b>336,627.04</b>	<b>(1,368.29)</b>	<b>100.4%</b>
Expenditures	Amt Budgeted	Expenditures	Remaining	
999 Ending Balance	335,258.75	0.00	335,258.75	0.0%
<b>Fund Expenditures:</b>	<b>335,258.75</b>	<b>0.00</b>	<b>335,258.75</b>	<b>0.0%</b>
<b>Fund Excess/(Deficit):</b>	<b>0.00</b>	<b>336,627.04</b>		



2023 BUDGET POSITION

City Of Stevenson

Time: 16:00:19 Date: 03/10/2023

Page: 4

020 Fire Reserve Fund		Months: 01 To: 02			
Revenues	Amt Budgeted	Revenues	Remaining		
308 Beginning Balances	1,650,586.13	1,650,586.13	0.00	100.0%	
360 Interest & Other Earnings	0.00	8,411.88	(8,411.88)	0.0%	
397 Interfund Transfers	25,000.00	0.00	25,000.00	0.0%	
<b>Fund Revenues:</b>	<b>1,675,586.13</b>	<b>1,658,998.01</b>	<b>16,588.12</b>	<b>99.0%</b>	
Expenditures	Amt Budgeted	Expenditures	Remaining		
999 Ending Balance	1,675,586.13	0.00	1,675,586.13	0.0%	
<b>Fund Expenditures:</b>	<b>1,675,586.13</b>	<b>0.00</b>	<b>1,675,586.13</b>	<b>0.0%</b>	
<b>Fund Excess/(Deficit):</b>	<b>0.00</b>	<b>1,658,998.01</b>			

2023 BUDGET POSITION

City Of Stevenson

Time: 16:00:19 Date: 03/10/2023

Page: 5

030 ARPA Months: 01 To: 02

Revenues	Amt Budgeted	Revenues	Remaining	
308 Beginning Balances	298,313.00	298,313.00	0.00	100.0%
330 Intergovernmental Revenues	0.00	0.00	0.00	0.0%
<b>Fund Revenues:</b>	<b>298,313.00</b>	<b>298,313.00</b>	<b>0.00</b>	<b>100.0%</b>
Expenditures	Amt Budgeted	Expenditures	Remaining	
999 Ending Balance	298,313.00	0.00	298,313.00	0.0%
<b>Fund Expenditures:</b>	<b>298,313.00</b>	<b>0.00</b>	<b>298,313.00</b>	<b>0.0%</b>
<b>Fund Excess/(Deficit):</b>	<b>0.00</b>	<b>298,313.00</b>		

## 2023 BUDGET POSITION

City Of Stevenson

Time: 16:00:19 Date: 03/10/2023

Page: 6

100 Street Fund		Months: 01 To: 02		
Revenues	Amt Budgeted	Revenues	Remaining	
308 Beginning Balances	75,740.56	75,740.56	0.00	100.0%
310 Taxes	418,000.00	59,873.40	358,126.60	14.3%
320 Licenses & Permits	600.00	25.00	575.00	4.2%
330 Intergovernmental Revenues	723,324.50	4,139.75	719,184.75	0.6%
360 Interest & Other Earnings	0.00	708.09	(708.09)	0.0%
390 Other Financing Sources	0.00	0.00	0.00	0.0%
397 Interfund Transfers	150,000.00	0.00	150,000.00	0.0%
<b>Fund Revenues:</b>	<b>1,367,665.06</b>	<b>140,486.80</b>	<b>1,227,178.26</b>	<b>10.3%</b>
Expenditures	Amt Budgeted	Expenditures	Remaining	
542 Streets - Maintenance	572,066.06	36,018.16	536,047.90	6.3%
543 Streets Admin & Overhead	121,582.50	20,340.61	101,241.89	16.7%
544 Road & Street Operations	25,000.00	803.82	24,196.18	3.2%
566 Substance Abuse	0.00	0.00	0.00	0.0%
594 Capital Expenditures	566,047.00	0.00	566,047.00	0.0%
597 Interfund Transfers	0.00	0.00	0.00	0.0%
999 Ending Balance	82,969.50	0.00	82,969.50	0.0%
<b>Fund Expenditures:</b>	<b>1,367,665.06</b>	<b>57,162.59</b>	<b>1,310,502.47</b>	<b>4.2%</b>
<b>Fund Excess/(Deficit):</b>	<b>0.00</b>	<b>83,324.21</b>		

2023 BUDGET POSITION

City Of Stevenson

Time: 16:00:19 Date: 03/10/2023

Page: 7

103 Tourism Promo & Develop Fund Months: 01 To: 02

Revenues	Amt Budgeted	Revenues	Remaining	
308 Beginning Balances	1,104,606.79	1,104,606.79	0.00	100.0%
310 Taxes	473,000.00	71,521.11	401,478.89	15.1%
360 Interest & Other Earnings	0.00	4,962.66	(4,962.66)	0.0%
<b>Fund Revenues:</b>	<b>1,577,606.79</b>	<b>1,181,090.56</b>	<b>396,516.23</b>	<b>74.9%</b>
Expenditures	Amt Budgeted	Expenditures	Remaining	
573 Cultural & Community Activities	432,628.27	15,859.46	416,768.81	3.7%
594 Capital Expenditures	282,000.00	0.00	282,000.00	0.0%
999 Ending Balance	862,978.52	0.00	862,978.52	0.0%
<b>Fund Expenditures:</b>	<b>1,577,606.79</b>	<b>15,859.46</b>	<b>1,561,747.33</b>	<b>1.0%</b>
<b>Fund Excess/(Deficit):</b>	<b>0.00</b>	<b>1,165,231.10</b>		

2023 BUDGET POSITION

City Of Stevenson

Time: 16:00:19 Date: 03/10/2023

Page: 8

105 Affordable Housing Fund Months: 01 To: 02

Revenues	Amt Budgeted	Revenues	Remaining	
308 Beginning Balances	12,435.11	12,435.11	0.00	100.0%
310 Taxes	5,000.00	348.63	4,651.37	7.0%
<b>Fund Revenues:</b>	<b>17,435.11</b>	<b>12,783.74</b>	<b>4,651.37</b>	<b>73.3%</b>
Expenditures	Amt Budgeted	Expenditures	Remaining	
999 Ending Balance	17,435.11	0.00	17,435.11	0.0%
<b>Fund Expenditures:</b>	<b>17,435.11</b>	<b>0.00</b>	<b>17,435.11</b>	<b>0.0%</b>
<b>Fund Excess/(Deficit):</b>	<b>0.00</b>	<b>12,783.74</b>		

2023 BUDGET POSITION

City Of Stevenson

Time: 16:00:19 Date: 03/10/2023

Page: 9

107 HEALing SCARS Fund Months: 01 To: 02

Revenues	Amt Budgeted	Revenues	Remaining	
308 Beginning Balances	10,190.57	10,190.57	0.00	100.0%
360 Interest & Other Earnings	0.00	0.00	0.00	0.0%
<b>Fund Revenues:</b>	<b>10,190.57</b>	<b>10,190.57</b>	<b>0.00</b>	<b>100.0%</b>
Expenditures	Amt Budgeted	Expenditures	Remaining	
999 Ending Balance	10,190.57	0.00	10,190.57	0.0%
<b>Fund Expenditures:</b>	<b>10,190.57</b>	<b>0.00</b>	<b>10,190.57</b>	<b>0.0%</b>
<b>Fund Excess/(Deficit):</b>	<b>0.00</b>	<b>10,190.57</b>		

2023 BUDGET POSITION

City Of Stevenson

Time: 16:00:19 Date: 03/10/2023

Page: 10

300 Capital Improvement Fund		Months: 01 To: 02		
Revenues	Amt Budgeted	Revenues	Remaining	
308 Beginning Balances	210,190.20	210,190.20	0.00	100.0%
310 Taxes	20,000.00	2,103.75	17,896.25	10.5%
360 Interest & Other Earnings	0.00	1,253.54	(1,253.54)	0.0%
<b>Fund Revenues:</b>	<b>230,190.20</b>	<b>213,547.49</b>	<b>16,642.71</b>	<b>92.8%</b>
Expenditures	Amt Budgeted	Expenditures	Remaining	
597 Interfund Transfers	0.00	0.00	0.00	0.0%
999 Ending Balance	230,190.20	0.00	230,190.20	0.0%
<b>Fund Expenditures:</b>	<b>230,190.20</b>	<b>0.00</b>	<b>230,190.20</b>	<b>0.0%</b>
<b>Fund Excess/(Deficit):</b>	<b>0.00</b>	<b>213,547.49</b>		



2023 BUDGET POSITION

City Of Stevenson

Time: 16:00:19 Date: 03/10/2023

Page: 11

311 First Street Months: 01 To: 02

Revenues	Amt Budgeted	Revenues	Remaining	
308 Beginning Balances	0.00	0.00	0.00	0.0%
330 Intergovernmental Revenues	0.00	0.00	0.00	0.0%
397 Interfund Transfers	0.00	0.00	0.00	0.0%
<b>Fund Revenues:</b>	<b>0.00</b>	<b>0.00</b>	<b>0.00</b>	<b>0.0%</b>
Expenditures	Amt Budgeted	Expenditures	Remaining	
594 Capital Expenditures	0.00	0.00	0.00	0.0%
999 Ending Balance	0.00	0.00	0.00	0.0%
<b>Fund Expenditures:</b>	<b>0.00</b>	<b>0.00</b>	<b>0.00</b>	<b>0.0%</b>
<b>Fund Excess/(Deficit):</b>	<b>0.00</b>	<b>0.00</b>		

2023 BUDGET POSITION

City Of Stevenson

Time: 16:00:19 Date: 03/10/2023

Page: 12

312 Columbia Ave		Months: 01 To: 02		
Revenues	Amt Budgeted	Revenues	Remaining	
308 Beginning Balances	(63,287.48)	(63,287.48)	0.00	100.0%
330 Intergovernmental Revenues	145,617.25	63,287.48	82,329.77	43.5%
<b>Fund Revenues:</b>	<b>82,329.77</b>	<b>0.00</b>	<b>82,329.77</b>	<b>0.0%</b>
Expenditures	Amt Budgeted	Expenditures	Remaining	
594 Capital Expenditures	82,329.77	7,804.37	74,525.40	9.5%
999 Ending Balance	0.00	0.00	0.00	0.0%
<b>Fund Expenditures:</b>	<b>82,329.77</b>	<b>7,804.37</b>	<b>74,525.40</b>	<b>9.5%</b>
<b>Fund Excess/(Deficit):</b>	<b>0.00</b>	<b>(7,804.37)</b>		

2023 BUDGET POSITION

City Of Stevenson

Time: 16:00:19 Date: 03/10/2023

Page: 13

400 Water/Sewer Fund		Months: 01 To: 02			
Revenues	Amt Budgeted	Revenues	Remaining		
400 Water/Sewer	1,151,234.64	1,151,234.64	0.00	100.0%	
401 Water	631,301.09	631,301.09	0.00	100.0%	
402 Sewer	175,778.18	175,778.18	0.00	100.0%	
<b>308 Beginning Balances</b>	<b>1,958,313.91</b>	<b>1,958,313.91</b>	<b>0.00</b>	<b>100.0%</b>	
343 Water	761,675.00	120,941.45	640,733.55	15.9%	
344 Sewer	1,322,308.13	220,467.25	1,101,840.88	16.7%	
<b>340 Charges For Goods &amp; Services</b>	<b>2,083,983.13</b>	<b>341,408.70</b>	<b>1,742,574.43</b>	<b>16.4%</b>	
343 Water	46,674.00	0.00	46,674.00	0.0%	
344 Sewer	56,532.00	0.00	56,532.00	0.0%	
400 Water/Sewer	4,000.00	9,350.12	(5,350.12)	233.8%	
<b>360 Interest &amp; Other Earnings</b>	<b>107,206.00</b>	<b>9,350.12</b>	<b>97,855.88</b>	<b>8.7%</b>	
380 Non Revenues	0.00	0.00	0.00	0.0%	
<b>Fund Revenues:</b>	<b>4,149,503.04</b>	<b>2,309,072.73</b>	<b>1,840,430.31</b>	<b>55.6%</b>	
Expenditures	Amt Budgeted	Expenditures	Remaining		
534 Water Utilities	876,312.89	129,887.71	746,425.18	14.8%	
535 Sewer	1,117,448.58	137,782.93	979,665.65	12.3%	
534 Water	60,854.54	0.00	60,854.54	0.0%	
535 Sewer	82,249.20	0.00	82,249.20	0.0%	
<b>591 Debt Service</b>	<b>143,103.74</b>	<b>0.00</b>	<b>143,103.74</b>	<b>0.0%</b>	
594 Capital Expenditures	272,160.00	11,931.11	260,228.89	4.4%	
597 Interfund Transfers	421,779.00	0.00	421,779.00	0.0%	
400 Water/Sewer	670,413.56	0.00	670,413.56	0.0%	
401 Water	415,975.09	0.00	415,975.09	0.0%	
402 Sewer	232,310.18	0.00	232,310.18	0.0%	
<b>999 Ending Balance</b>	<b>1,318,698.83</b>	<b>0.00</b>	<b>1,318,698.83</b>	<b>0.0%</b>	
<b>Fund Expenditures:</b>	<b>4,149,503.04</b>	<b>279,601.75</b>	<b>3,869,901.29</b>	<b>6.7%</b>	
<b>Fund Excess/(Deficit):</b>	<b>0.00</b>	<b>2,029,470.98</b>			

2023 BUDGET POSITION

City Of Stevenson

Time: 16:00:19 Date: 03/10/2023

Page: 14

406 Wastewater Short Lived Asset Res. Fund Months: 01 To: 02

Revenues	Amt Budgeted	Revenues	Remaining	
308 Beginning Balances	65,337.00	65,337.00	0.00	100.0%
397 Interfund Transfers	21,779.00	0.00	21,779.00	0.0%
<b>Fund Revenues:</b>	<b>87,116.00</b>	<b>65,337.00</b>	<b>21,779.00</b>	<b>75.0%</b>
Expenditures	Amt Budgeted	Expenditures	Remaining	
999 Ending Balance	87,116.00	0.00	87,116.00	0.0%
<b>Fund Expenditures:</b>	<b>87,116.00</b>	<b>0.00</b>	<b>87,116.00</b>	<b>0.0%</b>
<b>Fund Excess/(Deficit):</b>	<b>0.00</b>	<b>65,337.00</b>		

2023 BUDGET POSITION

City Of Stevenson

Time: 16:00:19 Date: 03/10/2023

Page: 15

408 Wastewater Debt Reserve Fund Months: 01 To: 02

Revenues	Amt Budgeted	Revenues	Remaining	
308 Beginning Balances	61,191.00	61,191.00	0.00	100.0%
397 Interfund Transfers	0.00	0.00	0.00	0.0%
<b>Fund Revenues:</b>	<b>61,191.00</b>	<b>61,191.00</b>	<b>0.00</b>	<b>100.0%</b>
Expenditures	Amt Budgeted	Expenditures	Remaining	
999 Ending Balance	61,191.00	0.00	61,191.00	0.0%
<b>Fund Expenditures:</b>	<b>61,191.00</b>	<b>0.00</b>	<b>61,191.00</b>	<b>0.0%</b>
<b>Fund Excess/(Deficit):</b>	<b>0.00</b>	<b>61,191.00</b>		

2023 BUDGET POSITION

City Of Stevenson

Time: 16:00:19 Date: 03/10/2023

Page: 16

410 Wastewater System Upgrades Months: 01 To: 02

Revenues	Amt Budgeted	Revenues	Remaining	
308 Beginning Balances	(1,179,179.71)	(1,179,179.71)	0.00	100.0%
330 Intergovernmental Revenues	5,028,740.07	0.00	5,028,740.07	0.0%
390 Other Financing Sources	9,637,369.64	970,783.64	8,666,586.00	10.1%
397 Interfund Transfers	400,000.00	0.00	400,000.00	0.0%
<b>Fund Revenues:</b>	<b>13,886,930.00</b>	<b>(208,396.07)</b>	<b>14,095,326.07</b>	<b>1.5%</b>
Expenditures	Amt Budgeted	Expenditures	Remaining	
592 Debt Service - Interest Costs	0.00	0.00	0.00	0.0%
594 Capital Expenditures	13,886,930.00	1,337,970.35	12,548,959.65	9.6%
999 Ending Balance	0.00	0.00	0.00	0.0%
<b>Fund Expenditures:</b>	<b>13,886,930.00</b>	<b>1,337,970.35</b>	<b>12,548,959.65</b>	<b>9.6%</b>
<b>Fund Excess/(Deficit):</b>	<b>0.00</b>	<b>(1,546,366.42)</b>		

2023 BUDGET POSITION

City Of Stevenson

Time: 16:00:19 Date: 03/10/2023

Page: 17

500 Equipment Service Fund			Months: 01 To: 02	
Revenues	Amt Budgeted	Revenues	Remaining	
308 Beginning Balances	157,311.97	157,311.97	0.00	100.0%
340 Charges For Goods & Services	175,000.00	30,350.00	144,650.00	17.3%
360 Interest & Other Earnings	0.00	764.53	(764.53)	0.0%
390 Other Financing Sources	0.00	0.00	0.00	0.0%
<b>Fund Revenues:</b>	<b>332,311.97</b>	<b>188,426.50</b>	<b>143,885.47</b>	<b>56.7%</b>
Expenditures	Amt Budgeted	Expenditures	Remaining	
548 Public Works - Centralized Services	141,544.23	30,355.21	111,189.02	21.4%
594 Capital Expenditures	100,000.00	71,456.77	28,543.23	71.5%
999 Ending Balance	90,767.74	0.00	90,767.74	0.0%
<b>Fund Expenditures:</b>	<b>332,311.97</b>	<b>101,811.98</b>	<b>230,499.99</b>	<b>30.6%</b>
<b>Fund Excess/(Deficit):</b>	<b>0.00</b>	<b>86,614.52</b>		



2023 BUDGET POSITION

City Of Stevenson

Time: 16:00:19 Date: 03/10/2023

Page: 18

630 Stevenson Municipal Court Months: 01 To: 02

Revenues	Amt Budgeted	Revenues	Remaining	
308 Beginning Balances	0.00	0.00	0.00	0.0%
380 Non Revenues	0.00	762.87	(762.87)	0.0%
<b>Fund Revenues:</b>	<b>0.00</b>	<b>762.87</b>	<b>(762.87)</b>	<b>0.0%</b>
Expenditures	Amt Budgeted	Expenditures	Remaining	
580 Non Expenditures	0.00	762.87	(762.87)	0.0%
999 Ending Balance	0.00	0.00	0.00	0.0%
<b>Fund Expenditures:</b>	<b>0.00</b>	<b>762.87</b>	<b>(762.87)</b>	<b>0.0%</b>
<b>Fund Excess/(Deficit):</b>	<b>0.00</b>	<b>0.00</b>		

## 2023 BUDGET POSITION TOTALS

City Of Stevenson

Months: 01 To: 02

Time: 16:00:19 Date: 03/10/2023

Page: 19

Fund	Revenue Budgeted	Received		Expense Budgeted	Spent	
001 General Expense Fund	2,906,408.55	1,672,981.93	57.6%	2,906,408.55	191,426.72	7%
010 General Reserve Fund	335,258.75	336,627.04	100.4%	335,258.75	0.00	0%
020 Fire Reserve Fund	1,675,586.13	1,658,998.01	99.0%	1,675,586.13	0.00	0%
030 ARPA	298,313.00	298,313.00	100.0%	298,313.00	0.00	0%
100 Street Fund	1,367,665.06	140,486.80	10.3%	1,367,665.06	57,162.59	4%
103 Tourism Promo & Develop Fund	1,577,606.79	1,181,090.56	74.9%	1,577,606.79	15,859.46	1%
105 Affordable Housing Fund	17,435.11	12,783.74	73.3%	17,435.11	0.00	0%
107 HEALing SCARS Fund	10,190.57	10,190.57	100.0%	10,190.57	0.00	0%
300 Capital Improvement Fund	230,190.20	213,547.49	92.8%	230,190.20	0.00	0%
311 First Street	0.00	0.00	0.0%	0.00	0.00	0%
312 Columbia Ave	82,329.77	0.00	0.0%	82,329.77	7,804.37	9%
400 Water/Sewer Fund	4,149,503.04	2,309,072.73	55.6%	4,149,503.04	279,601.75	7%
406 Wastewater Short Lived Asset Res	87,116.00	65,337.00	75.0%	87,116.00	0.00	0%
408 Wastewater Debt Reserve Fund	61,191.00	61,191.00	100.0%	61,191.00	0.00	0%
410 Wastewater System Upgrades	13,886,930.00	-208,396.07	-1.5%	13,886,930.00	1,337,970.35	10%
500 Equipment Service Fund	332,311.97	188,426.50	56.7%	332,311.97	101,811.98	31%
630 Stevenson Municipal Court	0.00	762.87	0.0%	0.00	762.87	0%
	<u>27,018,035.94</u>	<u>7,941,413.17</u>	<u>29.4%</u>	<u>27,018,035.94</u>	<u>1,992,400.09</u>	<u>7.4%</u>

# Washington Gorge Action Programs Skamania County Housing Programs

March 2023

Submitted by Keir Isaacson, Warming Shelter Coordinator.

Weather conditions in the month of February were not serious. Snow depth was not severe, lasting only for a few days at a time. Temperatures occasionally fell into the 20s. Several calls were received – the bulk seeking information. The few individuals who called and inquired about using the Warming Shelter services did not appear for intake, for reasons unknown.

Number of nights opened for services: 22

Number of households served: 0

Number of individuals within those households: 0

Total number of bed nights provided: 0

Number no shows: 3

Number of calls: 12

Number of entry's denied: 0

No covid incident's



## March 2023 Board Report

### Skamania County Housing Programs

Submitted by Curt Gray, Director, Skamania County Housing Programs

As an introduction to the monthly report we routinely submit, I'm including this narrative to provide additional insight. Data reported is for the month of February.

- **Rental Assistance:**

First-time requests for rental assistance are given priority.

In addition to the rental assistance for all programs that is reported for February, assistance has been provided to pay rents that were in arrears for months other than the reporting month. In the month of February, twelve (12) households comprising a total of thirty-one (31) individuals were served providing an additional 2940 bed-nights of assistance.

- **Denial of Services:**

One (1) household requesting rent assistance in February was denied having previously received significant rental assistance in prior months and reaching the maximum benefit.

**Washington Gorge Action Programs**  
**Skamania County Housing Programs**  
 Mar-2023  
 Submitted by Curt Gray

**Rental Assistance**

**Outputs**

	Feb
Number of households served	12
Number of individuals within those households	31
Total Number of bed nights provided	840

**Housing and Essential Needs**

**Outputs**

	Feb
Number of individuals served with Housing/Utilities	4
Number of individuals served with Essential Needs	7
Total Number of bed nights provided	112

**Permanent Support Housing**

	Feb
Number of individuals obtained employment	0
Number of individuals increasing their income	0
Number of individuals retained employment for 90 days or more	1
Number of HH removed Barriers that hindered individuals in obtaining job	0
Number of HH moved into affordable permanent housing	0
Number of HH Received referral to mainstream resources	4
Number of individuals completed Life Skills meeting	3
Number of individuals denied services	0

**Outputs PSH**

	Feb
Number of households served	5
Number of individuals within those households	6

**Shelter**

The shelter is open to individuals and families who are homeless. They are required to look for permanent housing during their stay.

**Outputs**

	Feb
Number of households served	3
Number of individuals within those households	4
Total Number of bed nights provided	112

**Total Outcomes for all Programs**

	Feb
Number of individuals obtained employment	0
Number of individuals increasing their income	1
Number of individuals retained employment for 90 days or more	0
Number of HH removed Barriers that hindered individuals in obtaining job	0
Number of HH moved into affordable permanent housing	1
Number of HH Received referral to mainstream resources	17
Number of individuals completed Life Skills meeting	18
Number of individuals denied services	1

**Success Stories**

February 2022:

1. No COVID outbreaks in our shelters
2. One (1) emergency shelter resident maintained employment
3. One (1) client enrolled in supportive housing obtained employment and permanent housing

# CHECK REGISTER

City Of Stevenson

Time: 19:43:54 Date: 03/14/2023

02/17/2023 To: 03/16/2023

Page: 1

Trans	Date	Type	Acct #	Chk #	Claimant	Amount	Memo
584	03/16/2023	Claims	1	EFT	Department of Revenue	6,076.02	February 2023 Taxes
585	03/16/2023	Claims	1	EFT	Kenneth B Woodrich PC	1,794.00	February 2023 Statement
417	02/22/2023	Claims	1	16712	Astound Broadband	6,636.00	Internet Installation at Water Treatment Plant-Construction Costs
425	02/23/2023	Claims	1	16713	Skamania County Auditor	206.50	Main D Latecomers Agreement-Loop Road
586	03/16/2023	Claims	1	16719	A&J Select	62.26	February 2023 Statement
587	03/16/2023	Claims	1	16720	Aramark Uniform Services	146.26	February 2023 Statement
588	03/16/2023	Claims	1	16721	Avista Utilities	1,773.78	February 2023 Statement
589	03/16/2023	Claims	1	16722	Azteca Systems Holdings, LLC	15,078.00	Cityworks Online Server/Logins
590	03/16/2023	Claims	1	16723	BSK Associates	1,794.50	February 2023 Statement; February 2023 Statement
591	03/16/2023	Claims	1	16724	Benjamin Shumaker	43.08	Armpads for Office Chair
592	03/16/2023	Claims	1	16725	Carson Hardware	9.69	Root Killer
593	03/16/2023	Claims	1	16726	CenturyLink	154.05	March 2023 WWTP Phone Service; March 2023 Kanaka Creek Transfer Station
594	03/16/2023	Claims	1	16727	Centurylink Comm Inc	46.83	February 223 WWTP Long Distance
595	03/16/2023	Claims	1	16728	City of Stevenson	3,581.03	February 2022 Statement; February 2022 Statement; February 2022 Statement; February 2022 Statement; February 2022 Statement; February 2022 Statement; February 2022 Statement;;
596	03/16/2023	Claims	1	16729	Class 5	288.58	March 2023 Fax Service; March 2023 Monthly Phone Service
597	03/16/2023	Claims	1	16730	Columbia Gorge Excavation LLC	1,400.10	Gravel-Stockpile
598	03/16/2023	Claims	1	16731	Columbia Hardware Inc	2,952.62	February 2023 Statement
599	03/16/2023	Claims	1	16732	Columbia River Disposal	201.58	February 2023 Garbage Disposal
600	03/16/2023	Claims	1	16733	Consolidated Supply Company	3,385.78	Meter Adaptors; Meter Resetters; Water Parts & Supplies; Water Parts/Supplies
601	03/16/2023	Claims	1	16734	Crestline Construction Company, LLC	21,089.95	Final Retainage
602	03/16/2023	Claims	1	16735	Crestview Custom Homes	357.42	Refund of Overpayment
603	03/16/2023	Claims	1	16736	DeVaul Publishing	285.60	Legal Ad-Ordinance 2023-1193 Adoption; Board of Adjustment Meeting Notice; Legal Ad-Notice of Special Council Meeting; Legal Ad-Special Council Meeting; Legal Ad-Special Council Meeting
604	03/16/2023	Claims	1	16737	Denali Water Solutions LLC	4,278.00	February 2023 Sludge Hauling
605	03/16/2023	Claims	1	16738	Jonathon D Dexter	163.00	Travel Reimbursement Wenatchee
606	03/16/2023	Claims	1	16739	Financial Consulting Solutions Group Inc	1,497.50	Water/Sewer/SDC Sewer Rate Study
607	03/16/2023	Claims	1	16740	Flo Analytics	2,846.25	On-call GIS Services
608	03/16/2023	Claims	1	16741	Gorge Auto Parts Inc	380.16	February 2023 Statement
609	03/16/2023	Claims	1	16742	Grainger	2,520.52	Replacement Pump for WTP
610	03/16/2023	Claims	1	16743	Grayling Engineers	10,346.52	Cascade Avenue Utility Improvements; 2022 Waterline Replacement
611	03/16/2023	Claims	1	16744	Gregory Scott Cheney	255.00	February 2023 Statement
612	03/16/2023	Claims	1	16745	H2Oregon	12.92	Drinking Water Dispenser for WWTP

## CHECK REGISTER

City Of Stevenson

Time: 19:43:54 Date: 03/14/2023

02/17/2023 To: 03/16/2023

Page: 2

Trans	Date	Type	Acct #	Chk #	Claimant	Amount	Memo
613	03/16/2023	Claims	1	16746	HD Fowler Company	8,718.23	Sewer Parts; 6" Check Valve Assembly
614	03/16/2023	Claims	1	16747	Kilmer, Voorhees & Laurick P.C.	1,065.00	Attend Council Meeting 2/16/2023; Phone Call Regarding Steller J
615	03/16/2023	Claims	1	16748	Kimball Midwest	20.57	Marking Paint
616	03/16/2023	Claims	1	16749	Klickitat-Skamania Utility Coord Council	40.00	2023 Annual Dues
617	03/16/2023	Claims	1	16750	Main Street - Singh	2,543.77	February 2023 Statement; February 2023 Statement-Remainder
618	03/16/2023	Claims	1	16751	Maul Foster Alongi	16,597.50	Columbia Avenue Realignment
619	03/16/2023	Claims	1	16752	Menke Jackson Beyer LLP	845.00	May Family BLA2021-07
620	03/16/2023	Claims	1	16753	Office of State Treasurer-Cash Mgmt Di	74.54	March Remittance
621	03/16/2023	Claims	1	16754	One Call Concepts Inc	7.49	February 2023 Statement-7 Locates
622	03/16/2023	Claims	1	16755	PUD No 1 of Skamania County	8,129.98	January 2023 Statement; February 2022 Statement; February 2023 Statement; February 2023 Statement; February 2023 Statement; February 2023 Statement
623	03/16/2023	Claims	1	16756	Petty Cash	263.97	February 2023 Statement
624	03/16/2023	Claims	1	16757	Print It! Inc	145.40	12x12 Logo Decals; Business Cards-Carson & Tiffany
625	03/16/2023	Claims	1	16758	RADCOMP Technologies	2,795.39	March 2023 Monthly Contract
626	03/16/2023	Claims	1	16759	Ricoh USA Inc	67.14	February 2023 Statement
627	03/16/2023	Claims	1	16760	SW Clean Air Agency	438.75	2023 Budget Assessment Share
628	03/16/2023	Claims	1	16761	Sea-Western Inc	1,371.99	Boots for Fire Department
629	03/16/2023	Claims	1	16762	William Sexton	490.50	Travel Reimbursement to Wenatchee
630	03/16/2023	Claims	1	16763	Skamania County Auditor		Needs to be two separate checks.
631	03/16/2023	Claims	1	16764	Skamania County Chamber of Commerce	11,118.14	February 2023 Statement
632	03/16/2023	Claims	1	16765	Skamania County Grange Hall	2,286.58	Reimbursement of charges for Grange Hall Building-building was condemned and there is no longer a water meter.
633	03/16/2023	Claims	1	16766	Skamania County Probation	134.73	February 2023 Probation Costs
634	03/16/2023	Claims	1	16767	Skamania County Prosecutor	1,500.00	March 2023 Remittance
635	03/16/2023	Claims	1	16768	Skamania County Sheriff	1,945.00	January 2023 Jail Services; February 2023 Jail Services
636	03/16/2023	Claims	1	16769	Skamania County Solid Waste Department	77.25	January 2023 Waste Disposal; Water Heater Disposal
637	03/16/2023	Claims	1	16770	Skamania County Treasurer		Quit Claim Deed needs to be separate check.
638	03/16/2023	Claims	1	16771	Stellar J Corporation	928,710.85	Progress Payment #8
639	03/16/2023	Claims	1	16772	Terrapin Investments	441.57	Reimbursement for 1/2 Sewer Line Camera-Rock Creek Tavern
640	03/16/2023	Claims	1	16773	Timothy Charles Shell	5,325.02	February 2023 Statement; February 2023 Statement; February 2023 Statement
641	03/16/2023	Claims	1	16774	US Bank Safekeeping	30.00	February 2023 US Bank Safekeeping Fees
642	03/16/2023	Claims	1	16775	US Bank Voyager Fleet Systems	78.02	February 2023 Statement



# CHECK REGISTER

City Of Stevenson

Time: 19:43:54 Date: 03/14/2023

02/17/2023 To: 03/16/2023

Page: 3

Trans	Date	Type	Acct #	Chk #	Claimant	Amount	Memo
643	03/16/2023	Claims	1	16776	US Bank	6,289.98	February 2023 FD Credit Card Statement; February 2023 Card #1 Credit Card Statement; February 2023 Card #2 Credit Card Statement
644	03/16/2023	Claims	1	16777	USA Bluebook	2,514.34	Chemical Feed Pump Replacement; Replacement Water Pump Parts
645	03/16/2023	Claims	1	16778	Verizon Wireless	111.70	February 2023 Cell Phone Charges
646	03/16/2023	Claims	1	16779	Wallis Engineering PLLC	74,712.17	2021 WWCollection System Upgrades; WWTP Improvements Bidding & Construction
647	03/16/2023	Claims	1	16780	Wave Division Holdings LLC	286.15	March 2023 City Hall Internet; March 2023 Firehall Internet; March 2023 WWTP Services
648	03/16/2023	Claims	1	16781	Carson J Whitney	200.00	Boot Allowance
651	03/16/2023	Claims	1	16782	Skamania County Auditor	206.50	Quitclaim Deed filing for First Street Turnback (TB 4-0063)
652	03/16/2023	Claims	1	16783	Skamania County Auditor	204.50	Record Resolution No. 2023-403
653	03/16/2023	Claims	1	16784	Skamania County Treasurer	10.00	Quitclaim Deed filing for First Street Turnback (TB 4-0063)
654	03/16/2023	Claims	1	16785	Skamania County Treasurer	18,479.44	March 2023 Remittance; March 2023 Remittance
						32,119.48	
						13,367.72	
						11,499.91	
						16,597.50	
						74,723.46	
						1,033,179.29	
						6,377.32	
						75.98	
						1,187,940.66	Claims: 1,187,940.66
* Transaction Has Mixed Revenue And Expense Accounts						1,187,940.66	

CERTIFICATION: I, the undersigned do hereby certify under penalty of perjury, that the materials have been furnished, the services rendered or the labor performed as described herein, that any advance payment is due and payable pursuant to a contract or is available as an option for full or partial fulfillment of a contractual obligation, and that the claim is a just, due and unpaid obligation against the City of Stevenson, and that I am authorized to authenticate and certify to said claim.

Clerk Treasurer: \_\_\_\_\_ Date: \_\_\_\_\_

Claims Vouchers Reviewed By:

Signed: \_\_\_\_\_

Signed: \_\_\_\_\_

Signed: \_\_\_\_\_

Auditing Committee (Councilmembers or Mayor)