



PARKS & TRAILS ADVISORY BOARD

Wednesday, May 08, 2024 at 6:00 PM
Zoom

AGENDA

TO ATTEND THE MEETING ONLINE VIA ZOOM:

Please use this link:<https://us02web.zoom.us/j/84264600830>

ROLL CALL

CHANGES TO THE AGENDA

PUBLIC COMMENT

The Board Chair will call on each person when it is their turn to speak. You will have 3 minutes.

CONSENT AGENDA

1. Approval of Minutes

NEW BUSINESS

OLD BUSINESS

2. John Wallace will provide an update on the branding of the Action Sports Park at Cedar Park.
3. Tiana will give an update on the Tupper park playground and Tupper park updates
4. Tiana will provide an update on the re-opening of the Tickle Creek Trail.
5. Rochelle will show pictures and speak on the Grand Opening of the Cedar Creek Trail that occurred on April 6th, 2024.
6. Rochelle will discuss progress on the Sandy Bluff Dog park upgrades.
7. Rochelle will show images and videos of the progress of the construction of Cedar park.
8. Rochelle will provide an update on the Deer Pointe Park design.

STAFF UPDATES

ADJOURN

Americans with Disabilities Act Notice: Please contact Sandy City Hall, 39250 Pioneer Blvd. Sandy, OR 97055 (Phone: 503-668-5533) at least 48 hours prior to the scheduled meeting time if you need an accommodation to observe and/or participate in this meeting.



PARKS & TRAILS ADVISORY BOARD

Item # 1.

Wednesday, March 13, 2024 at 6:00 PM
Zoom

MINUTES

THIS MEETING IS BEING HELD ONLINE VIA ZOOM:

<https://us02web.zoom.us/j/84264600830>

ROLL CALL

PRESENT

Ryan Aultman
David Breames
Alexandria Gale
Don Robertson
Kimberly Seigal
Will Toogood

ABSENT

Upekala Wijayratne

Guest presenters:

Jason Williams, American Ramp Company

Kurt Lango, Lango Hansen Landscape Architects

Brian Martin, Lango Hansen Landscape Architects

Carly Boise, Lango Hansen Landscape Architects

Staff Present:

Rochelle AnderholmParsch, Parks & Recreation Director

John Wallace, Recreation and Center Manager

Tiana Rundell, Parks & Facilities Manager

Chelsea Jarvis, Executive Assistant

Caroleana Smallwood, Client Services Coordinator

CHANGES TO THE AGENDA

PUBLIC COMMENT

The Board Chair will call on each person when it is their time to speak for 3 minutes.

CONSENT AGENDA

1. Approval of Minutes:

January Minutes 2024

February Minutes 2024

Motion to approve January/February minutes

Motion made by Toogood, Seconded by Aultman.

Voting Yea: Aultman, Breames, Gale, Robertson, Seigal, Toogood

NEW BUSINESS

2. Spoke and Wheel (American Ramp Company) will show a few branding/marketing concepts for the new Skate park/pump track.

John introduces Jason with American Ramp Company. John then presents the 6 design options.

Questions were asked about community input, and the name Basecamp in regards to trademarks and the brewery in Portland.

Discussion ensued.

Will liked option D.

Ryan liked option E.

Alex liked C- likes the colors- thought it had character and was original.

Kim liked option E, thought it was nostalgic, as well as option C.

David liked option C.

Kim added the topo map in option F was a cool trendy feature. Thought it tied into the name Basecamp. Alex agrees.

Don liked option F & C.

Rochelle summarizes the consensus was option C plus the colors of option D.

The group concluded by talking about using the Sandy River or park location topography in option F.

OLD BUSINESS

3. Lango Hansen will review the first Open House and the Council meeting that occurred on March 4th.

Rochelle introduced Deer Pointe.

Brian from Lango Hansen presents a slide deck.

A recap of the council meeting on 3/4 was that pickleball might be a better fit in a community park instead of a neighborhood park. A covered full court basketball court was also mentioned. Option two was the most well received by the council.

The Open house on 3/6 also revealed that option two was the most well liked.

A final comment that was mentioned by Lango Hansen was that a full basketball court would fit in option 2, however specifics would need to be nailed down.

The group then talked about playground equipment based on some options presented by Lango Hansen:

Kim- likes inclusive play.

Don mentioned that climbing play equipment is popular but can have wear and tear issues. He likes the idea of diversity amongst parks.

Kim- Likes diverse playground options- and the combination option presented.

Alex- Likes to have options around the city. Also likes the combination option.

Finally a schedule update is presented.

STAFF UPDATES

Rochelle shares pictures of the demo progress and also the Sandy Bluff Dog Park progress.

Tiana's Updates:

Cedar Creek trail opening is April 6th. The parks team had to do a little storm clean up on the Cedar Creek trail.

The bleachers from the pool sold for \$1600.

The department is harvesting trees from the demo site for Hamilton Ridge Park.

Anti slip treads have been added to Fantasy Forest.

15 trees have been identified on the Tickle Creek trail for removal. The city is beginning to clear Bridge 1 tomorrow. Ant Farm has helped a ton with the Tickle Creek clean up so far. Risks need to be abated before we can reopen Tickle Creek to the public.

John's Updates:

The Senior center's pool table was donated to Ant Farm's new youth center.

The Silent Disco event had almost 50 teens in attendance.

The Mountain Storm jamboree is Saturday.

4. Caroleana Smallwood, Client Services Coordinator, will provide information on Senior Services offered through the center.

Rochelle introduced Caroleana.

Caroleana presents a presentation.

One question was asked if all centers run similarly.

ADJOURN

Americans with Disabilities Act Notice: Please contact Sandy City Hall, 39250 Pioneer Blvd. Sandy, OR 97055 (Phone: 503-668-5533) at least 48 hours prior to the scheduled meeting time if you need an accommodation to observe and/or participate in this meeting.

Parks & Trails Advisory Board

Meeting

5/8/24

Agenda Item # 2

Action Sports Park Branding



Agenda Item # 3

Tupper Playground and Park Update















Agenda item # 4

Tickle Creek Trail Update









Agenda item # 5
Cedar Creek Trail Grand
Opening Pictures











Agenda item # 6

Sandy Bluff Dog Park Upgrade

Progress Pictures















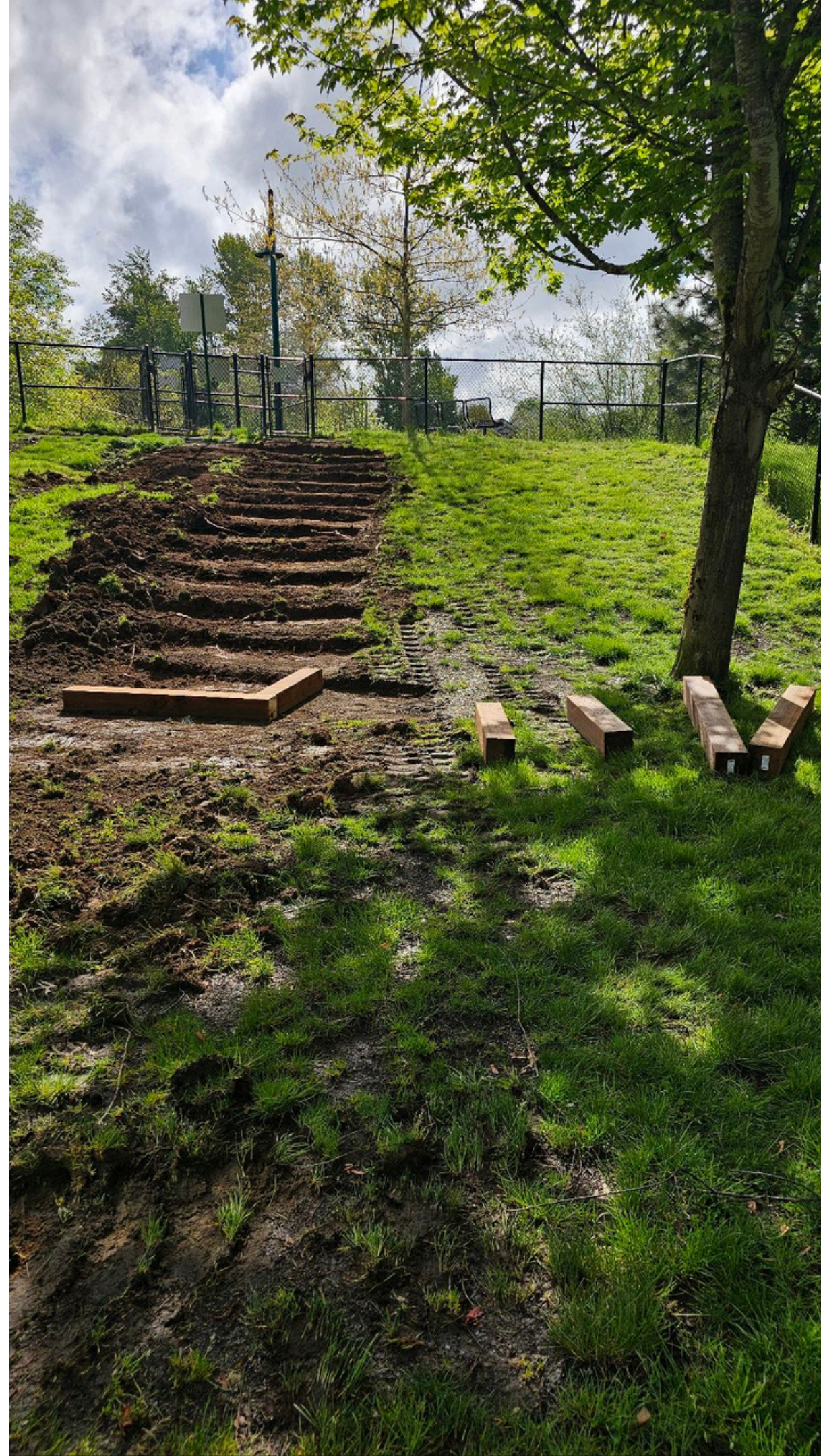

Agenda Item # 7

Cedar Park Construction

Progress Videos

- NOTE:
 1. SEE SIGN FLASHT FOR TYPICAL STONE WALL PATTERN FOR STYL. USED FOR PARK SIGN LETTER AND METAL NUMBER. PATTERN COINC. WITH CORE.

CEDAR PARK

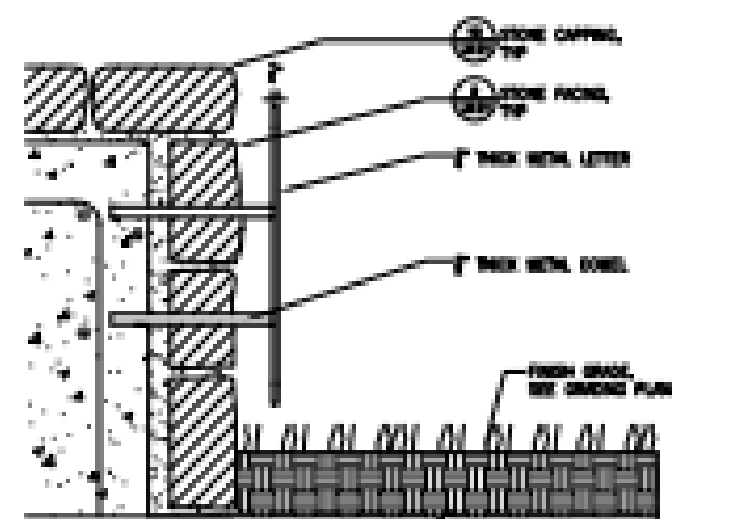
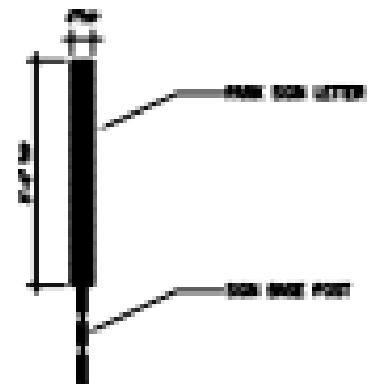
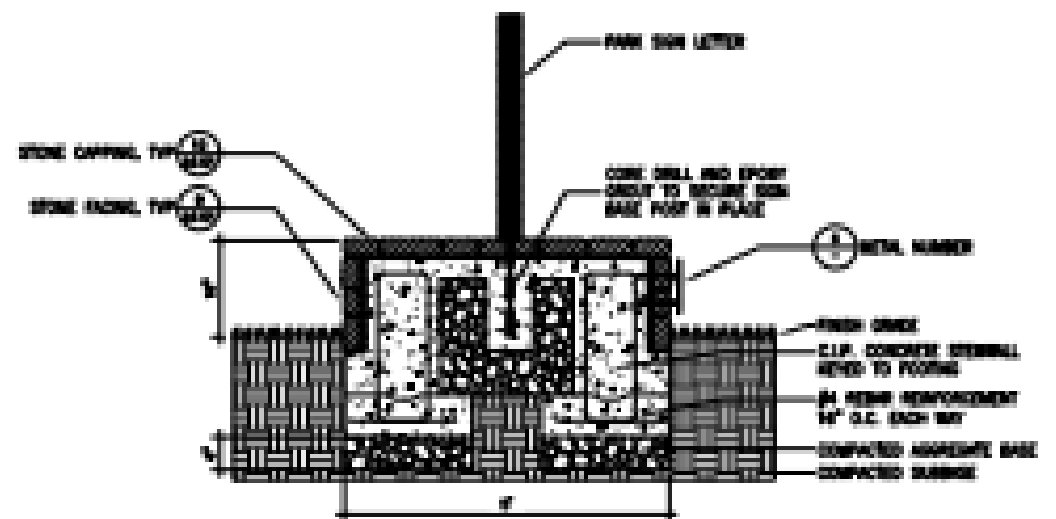
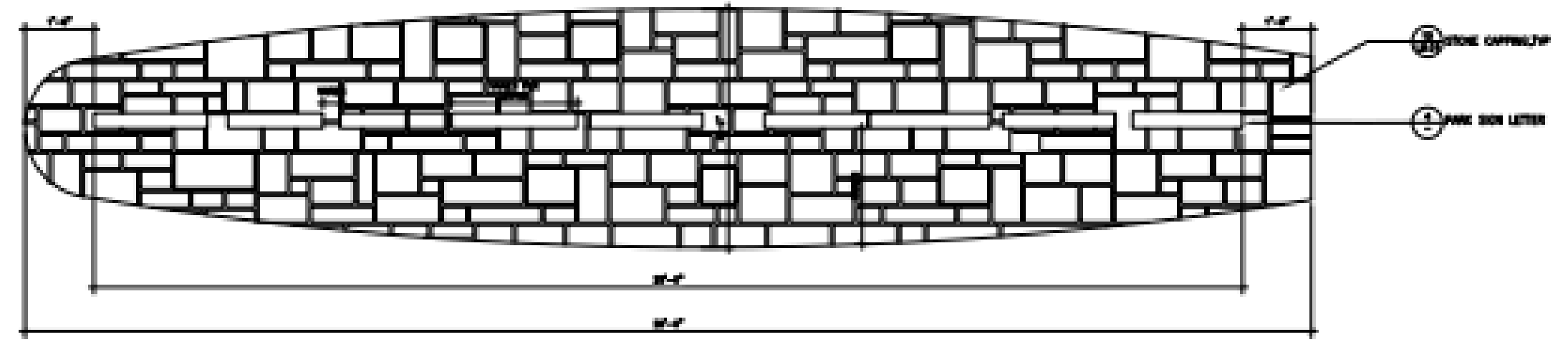
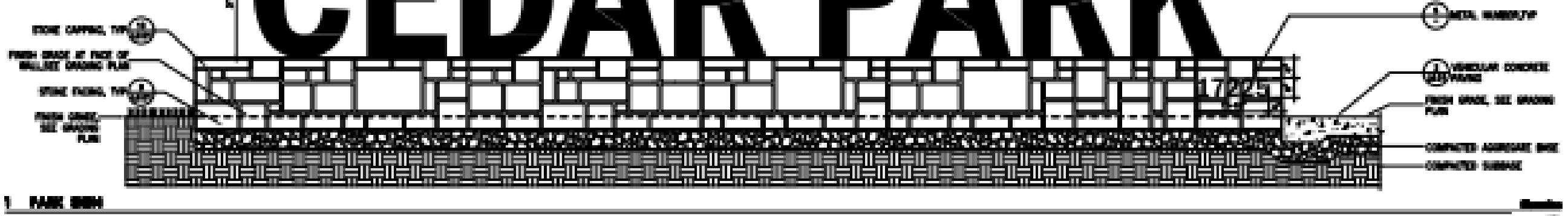









Show Cedar Park Videos

Agenda Item # 8

Deer Pointe Park Design Update



PARK AMENITIES

-  1 Playground
-  2 Shelter
-  3 Half Court Basketball
(2 wheel Full Court Option)
-  4 Open Lawn
-  5 Shrubs and Groundcover