



**PUBLIC WORKSHOP - JOHN'S PASS  
VILLAGE ACTIVITY CENTER  
ZONING AGENDA**

**Saturday, January 27, 2024 at 10:00 AM  
Commission Chambers, 300 Municipal Drive,  
Madeira Beach, FL 33708**

---

Meetings will be televised on Spectrum Channel 640 and YouTube Streamed on the City's Website.

---

1. **Staff presentation with open workshop stations to follow.**
  - A.** Presentation
  - B.** Worksheet

An aerial photograph of John's Pass Village, Florida, showing a mix of residential and commercial buildings along the waterfront. The water is filled with numerous boats and yachts. The text 'John's Pass Village Activity Center Zoning Workshop' is overlaid in large white font on a semi-transparent dark rectangle.

# John's Pass Village Activity Center Zoning Workshop

# WHY

- Protect the Village
- Compatible redevelopment
- Consistency with the Countywide Plan
- Proactive instead of Reactive Planning

**Legend**

— John's Pass Village Activity Center Study Area

0.1 0.05 0 0.1 Miles



# Relationship with Local Land Regulations

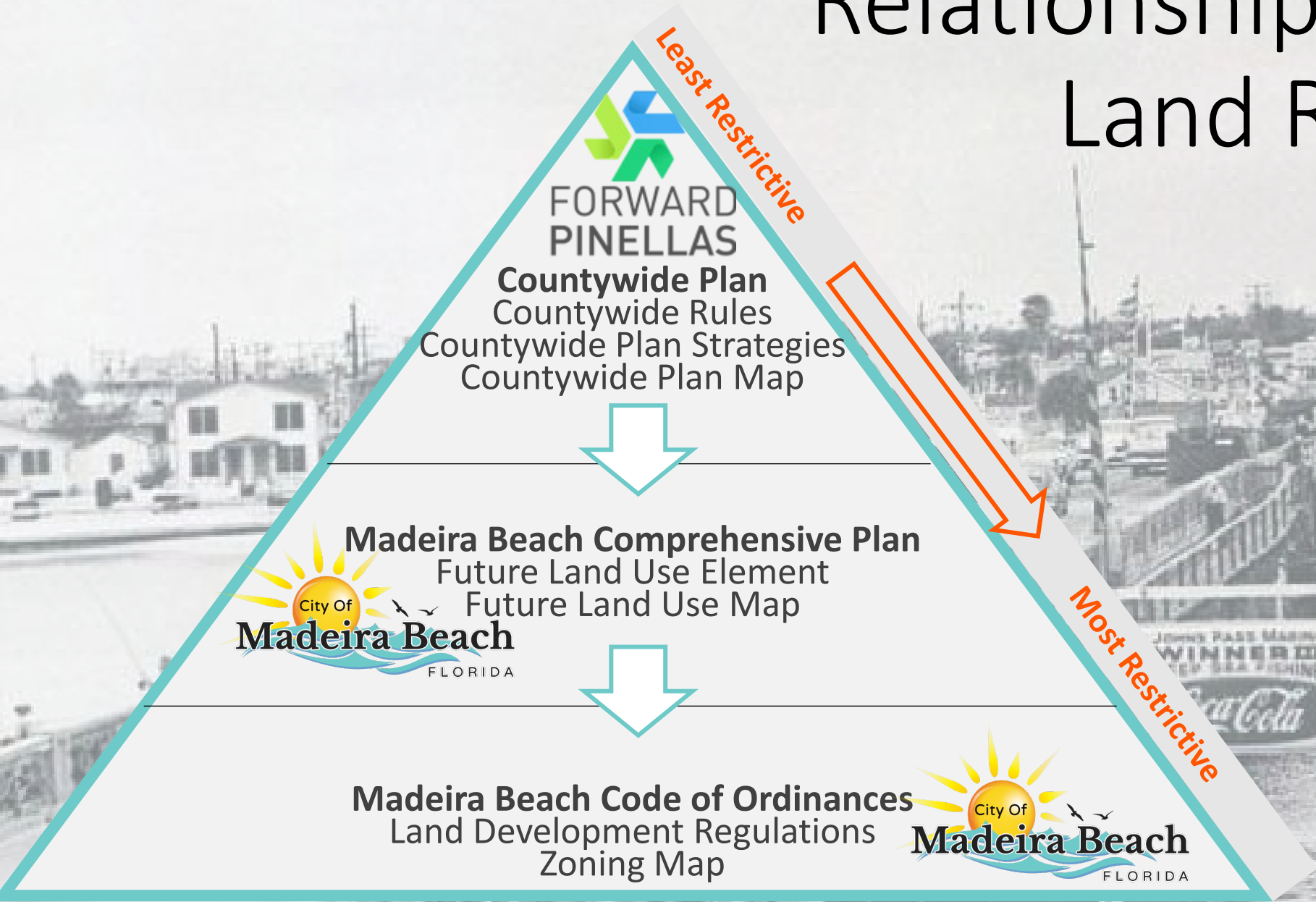

# COUNTYWIDE PLAN MAP

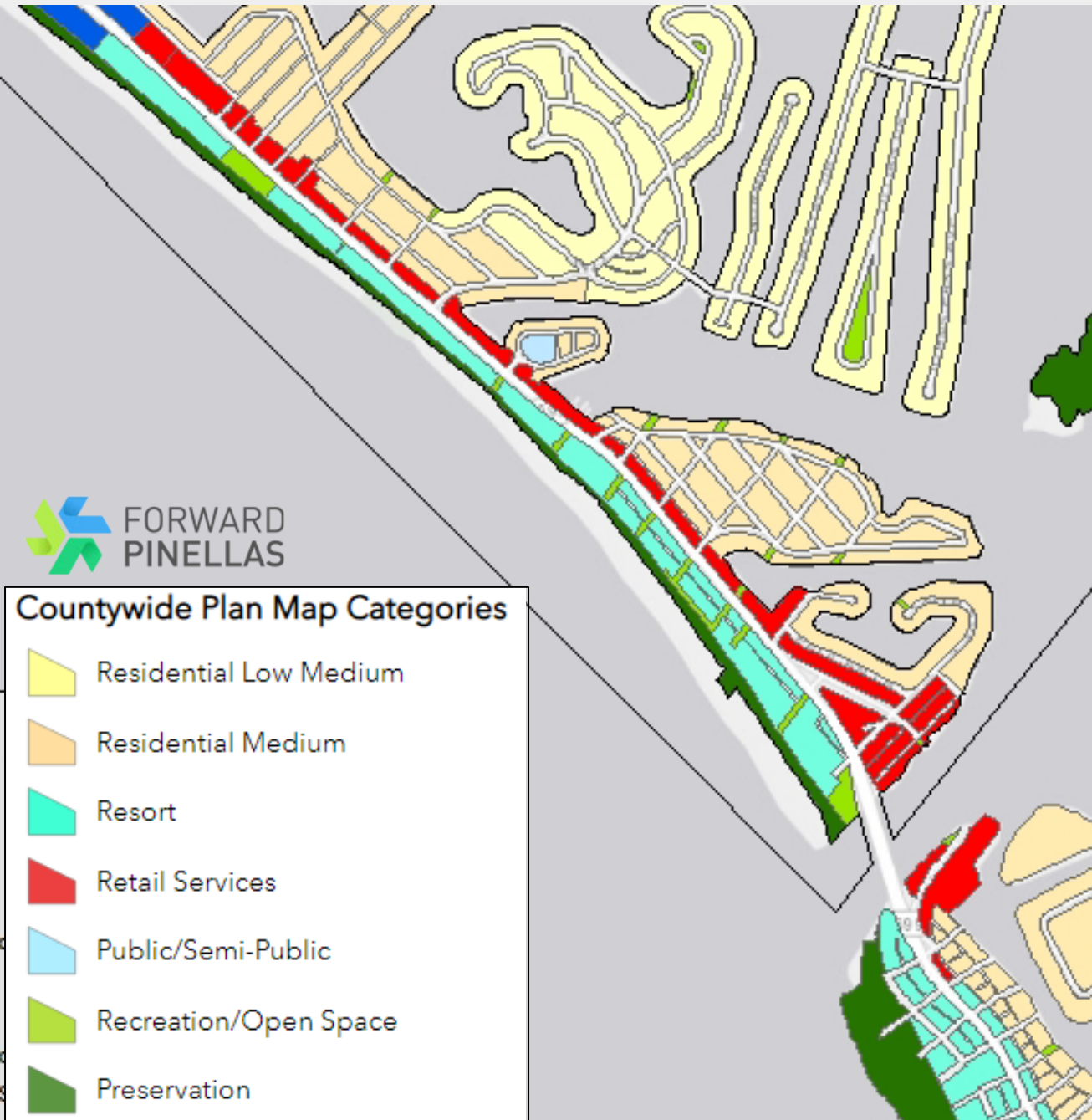

## Countywide Plan Map Categories

- Residential Low Medium
- Residential Medium
- Resort
- Retail Services
- Public/Semi-Public
- Recreation/Open Space
- Preservation

# MADEIRA BEACH ZONING MAP

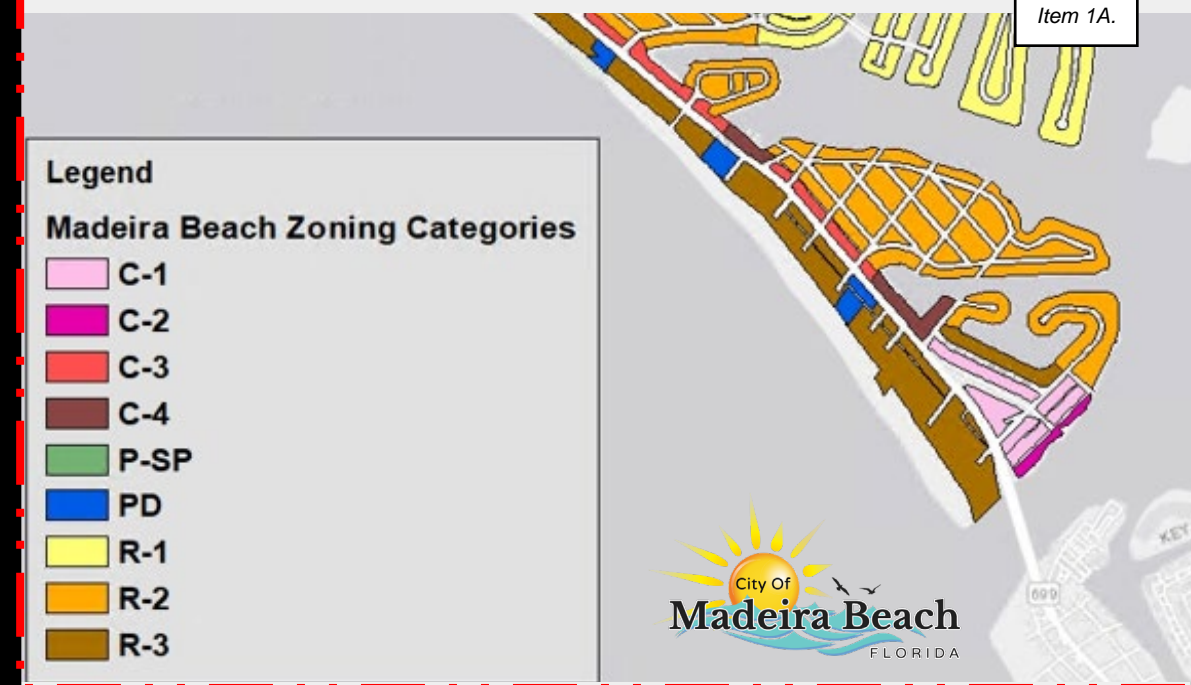

Item 1A.

- Legend**
- Madeira Beach Zoning Categories**
- C-1
  - C-2
  - C-3
  - C-4
  - P-SP
  - PD
  - R-1
  - R-2
  - R-3



# MADEIRA BEACH FUTURE LAND USE MAP

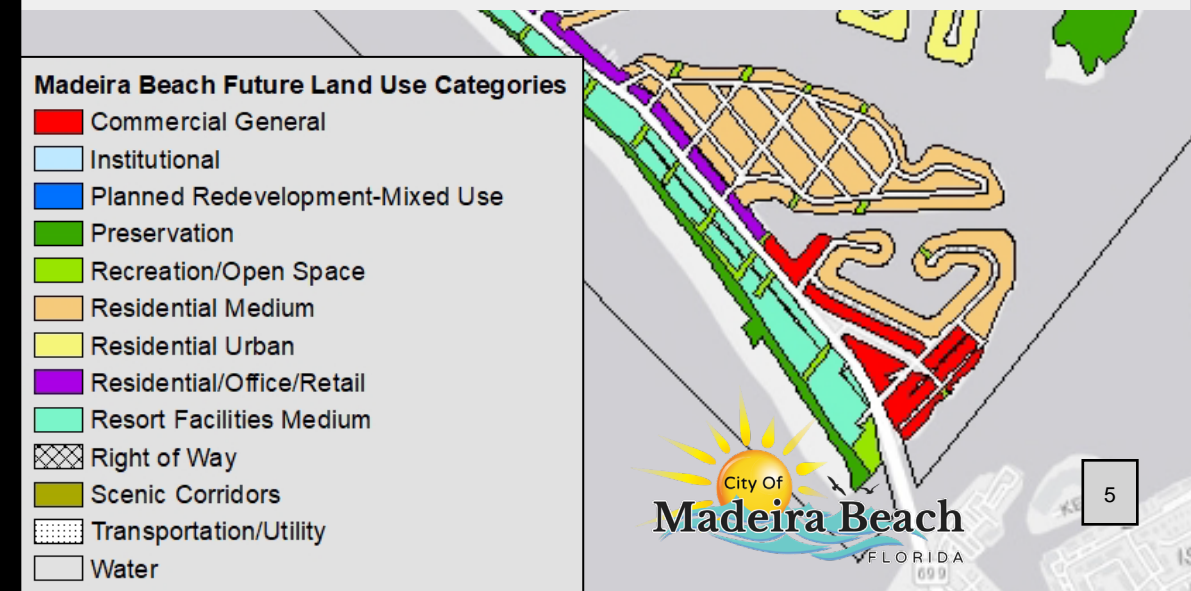

5

- Madeira Beach Future Land Use Categories**
- Commercial General
  - Institutional
  - Planned Redevelopment-Mixed Use
  - Preservation
  - Recreation/Open Space
  - Residential Medium
  - Residential Urban
  - Residential/Office/Retail
  - Resort Facilities Medium
  - Right of Way
  - Scenic Corridors
  - Transportation/Utility
  - Water



# EXISTING DENSITIES AND INTENSITIES

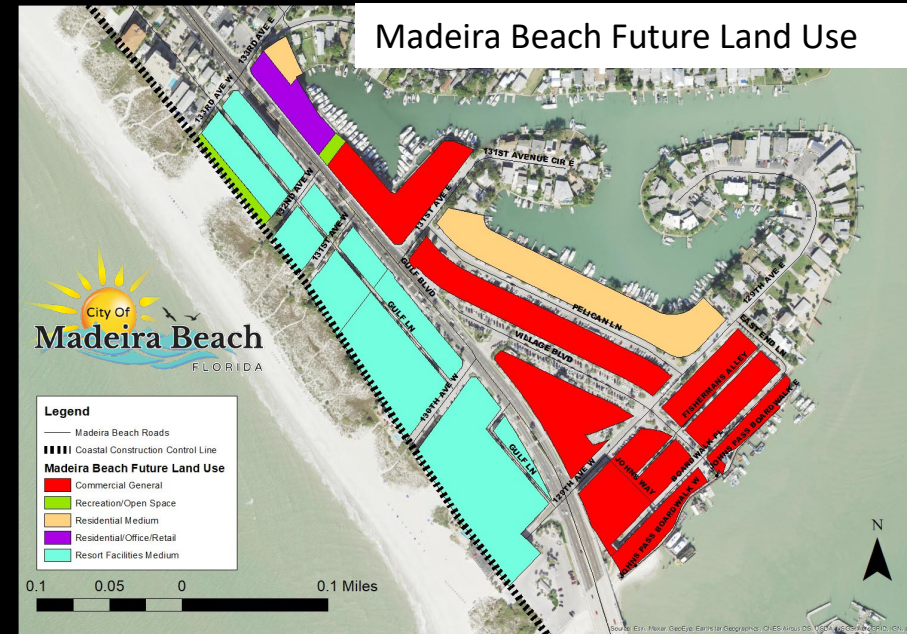
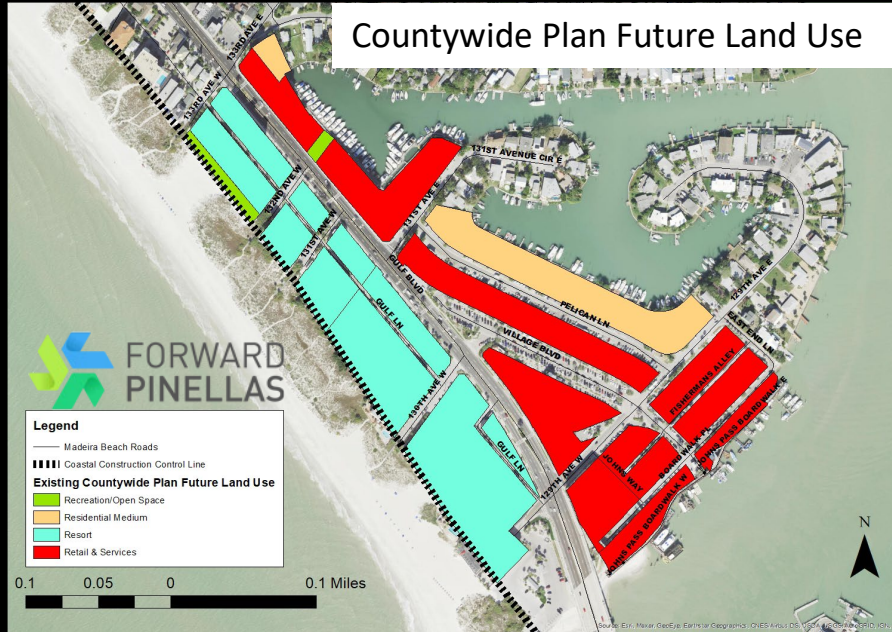

Countywide Plan Future Land Use			Madeira Beach Comprehensive Plan Future Land Use		
<b>Retail and Services</b>	FAR 0.55	RES UPA: 24 TEMP UPA: 40	<b>Commercial General</b>	FAR 1.2	RES UPA: 15 TEMP UPA: 60
<b>Resort</b>	FAR 1.2	RES UPA: 30 TEMP UPA: 50	<b>Residential/Office/Retail</b>	FAR 1.0	RES UPA: 18 TEMP UPA: 45
<b>Residential Medium</b>	FAR 0.5	RES UPA: 15 TEMP UPA: 0	<b>Resort Facilities Medium</b>	FAR 1.0 – 2.0 (Depends on Lot Area)	RES UPA: 18 TEMP UPA: 45-75
<b>Recreation/Open Space</b>	FAR 0.25	RES UPA: 0 TEMP UPA: 0	<b>Residential Medium</b>	Not specified in Comp Plan. In Zoning	RES UPA: 15 TEMP UPA: 0
			<b>Recreation/Open Space</b>	FAR 0.25	RES UPA: 0 TEMP UPA: 0

# John's Pass Village Activity Center

Item 1A.



**Legend**

- Madeira Beach Roads
- |||| Coastal Construction Control Line
- Proposed Future Land Use Category**
- Activity Center (Neighborhood Center)

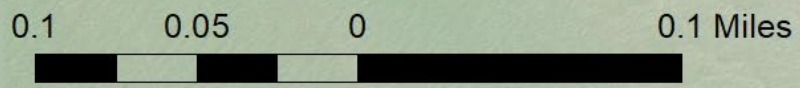

# Proposed Activity Center Plan: Character Districts

Traditional Village

Commercial Core

Boardwalk

John's Pass Resort

Low Intensity Mixed Use

Transitional





# Countywide Plan Map

### Existing Countywide Plan Map Future Land Use

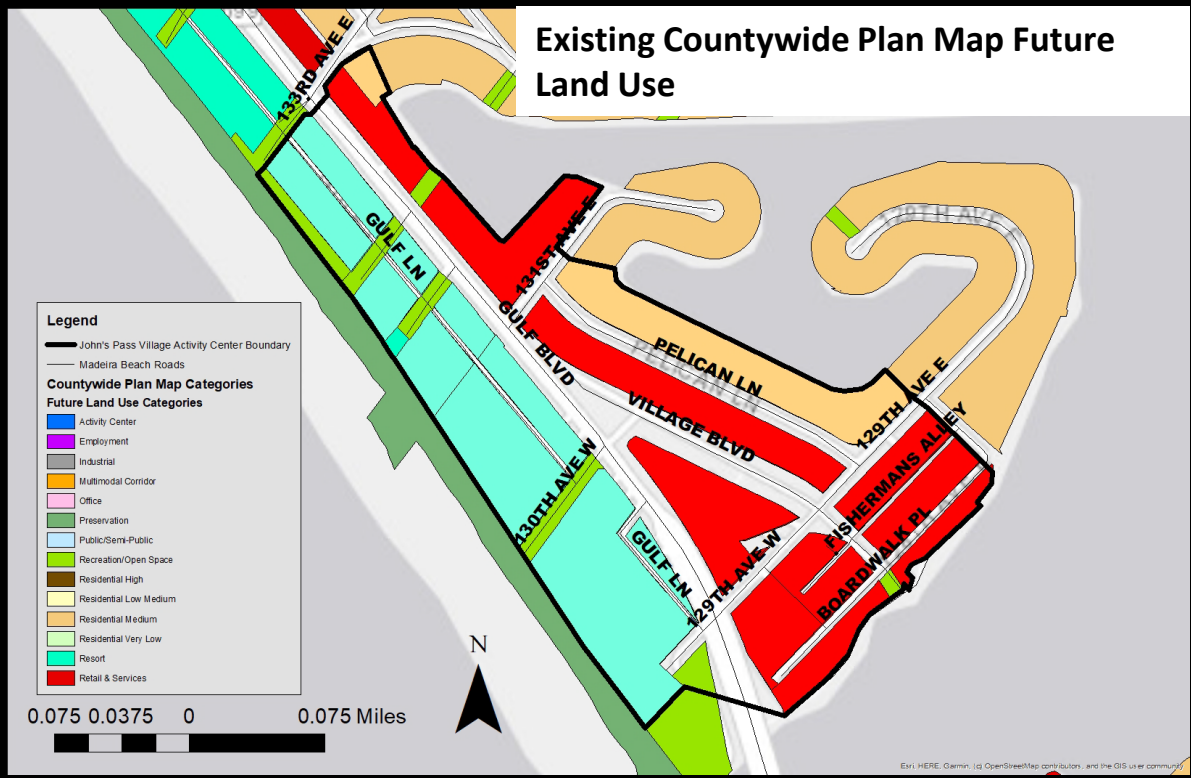

### Proposed Countywide Plan Map Future Land Use

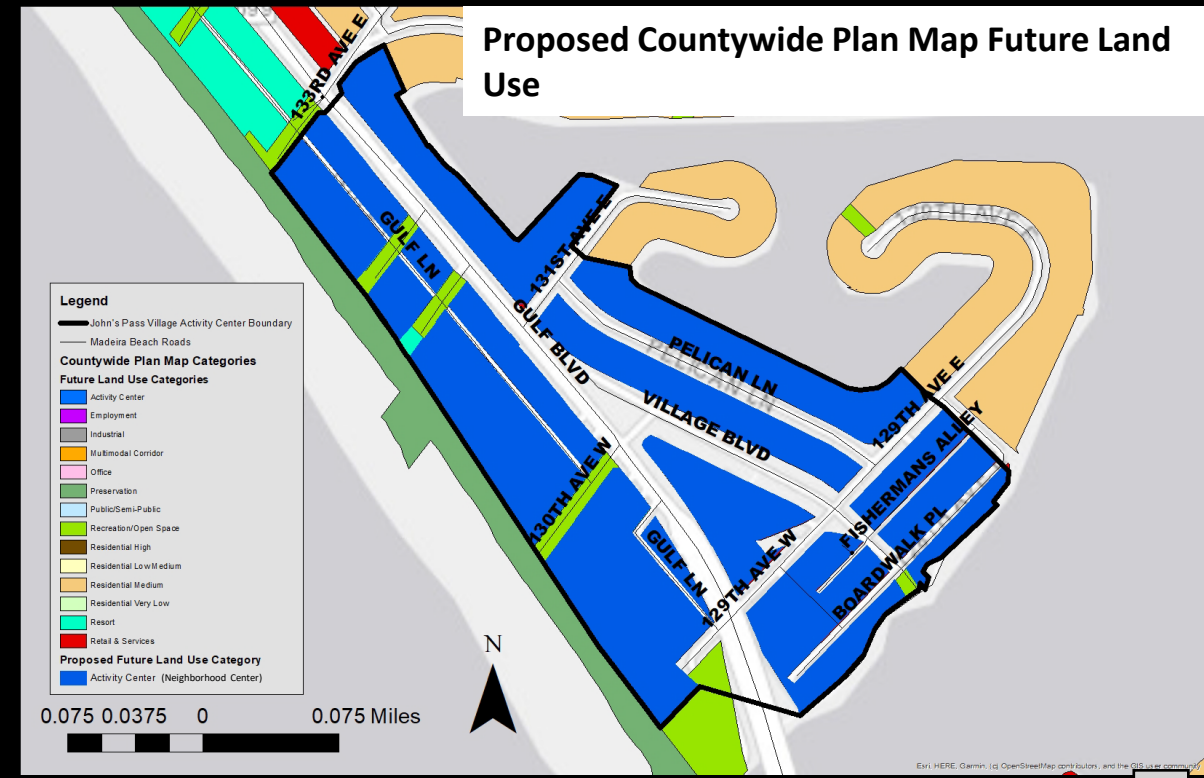

# Madeira Beach Future Land Use Map

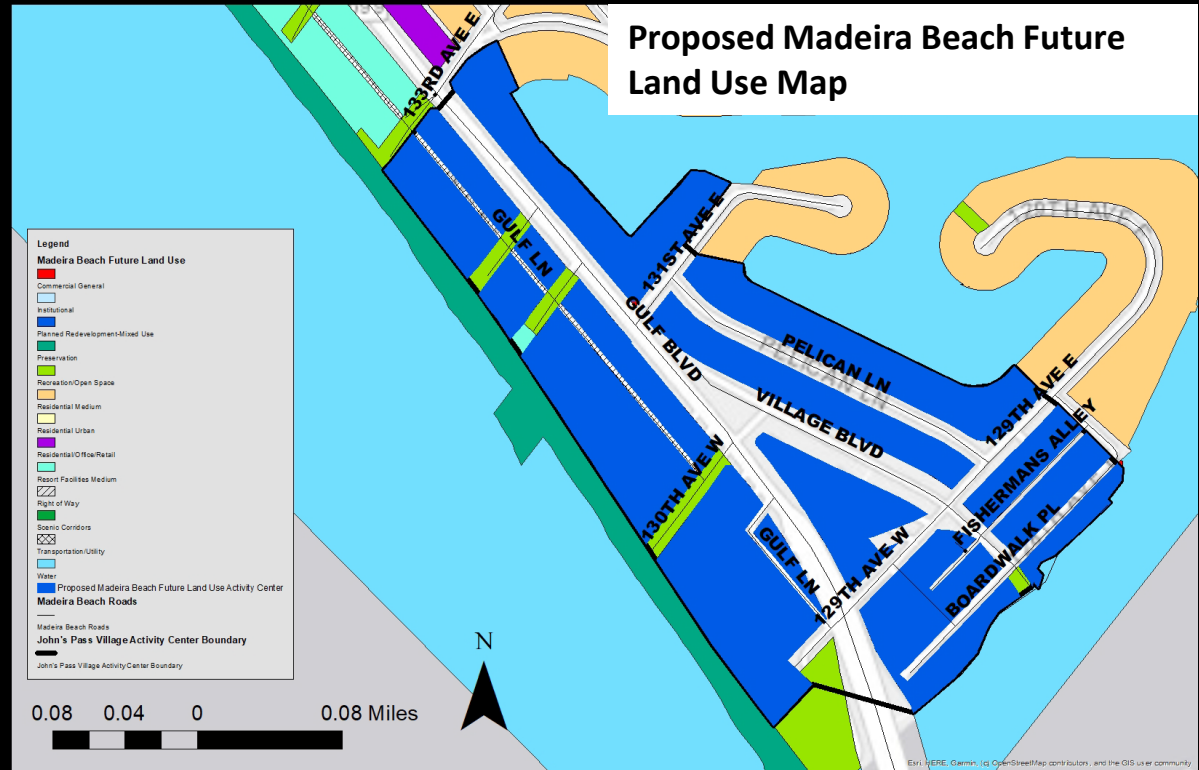
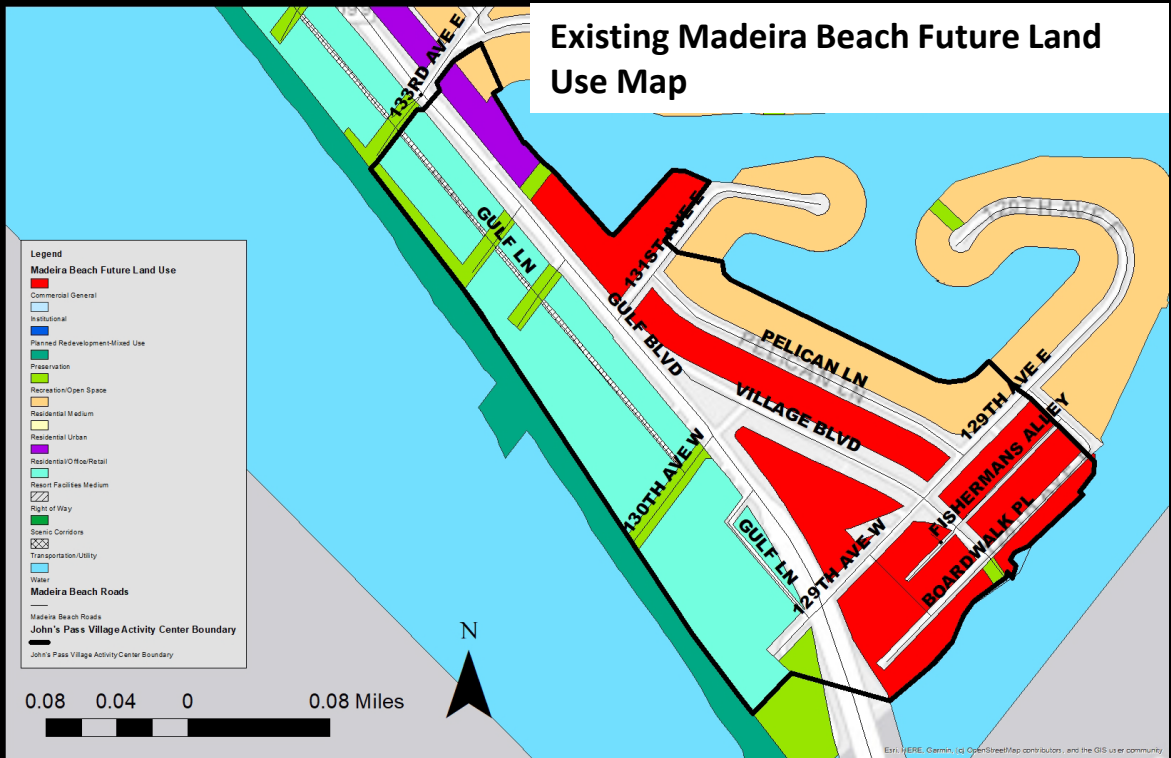

# Madeira Beach Zoning Map

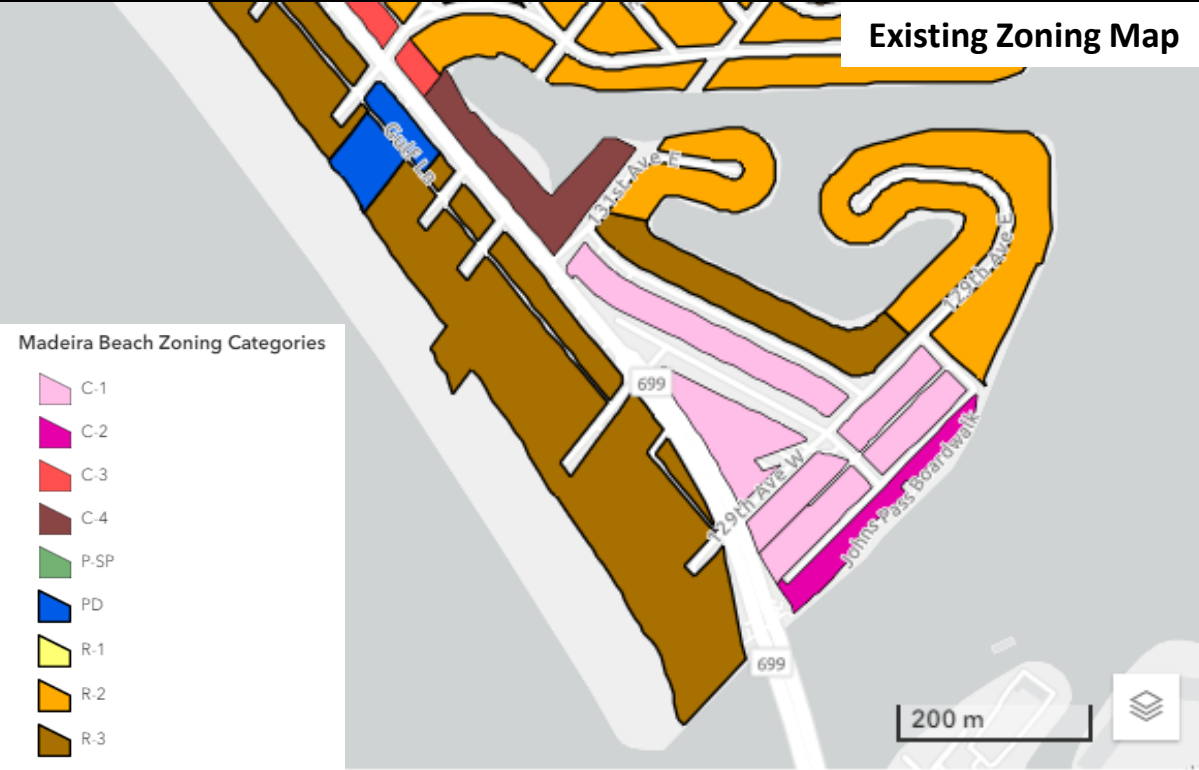

FAR: 1.5/2.0\*  
Temp UPA: 50/75\*  
Res UPA: 18

FAR: 1.5/2.0\*  
Temp UPA: 40/60\*  
Res UPA: 18

FAR: 2.0  
Temp UPA: 45  
Res UPA: 15

FAR: 2.0/2.2-3.0\*  
Temp UPA: 60/75-100\*  
Res UPA: 15

FAR: 2.0/2.2-2.5\*  
Temp UPA: 60/75-100\*  
Res UPA: 18

FAR: 1.5  
Temp UPA: 0  
Res UPA: 0

**Legend**

- Madeira Beach Roads
- ▬▬▬▬ Coastal Construction Control Line

**John's Pass Village Activity Center Character Districts**

- Boardwalk
- Commercial Core
- John's Pass Resort
- Low Intensity Mixed Use
- Tradional Village
- Transitional

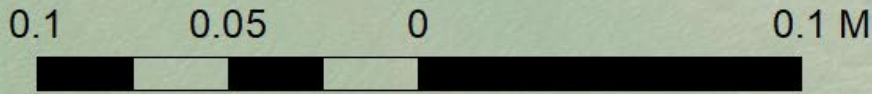

# Madeira Beach Code of Ordinances

## Zoning Districts

- Setbacks
- Height
- Impervious Surface Ratio
- Special Requirements
  - Design Standards
    - not allowed for single-family and duplex
    - Architectural features
  - Buffering Requirements
    - Use and Zone-specific landscaping

## Land Development Regulations

- Landscaping
- Sidewalks and Driveways
- Accessory Structures
- Parking Standards
- Swimming Pools

# Madeira Beach Land Development Regulations

## C-1 Zoning

Setbacks: Front Yard (none), Side Yard (10 ft one side), Rear Yard (25 ft)

Height: 34 ft

Floor Area Ratio: 0.55 for commercial uses

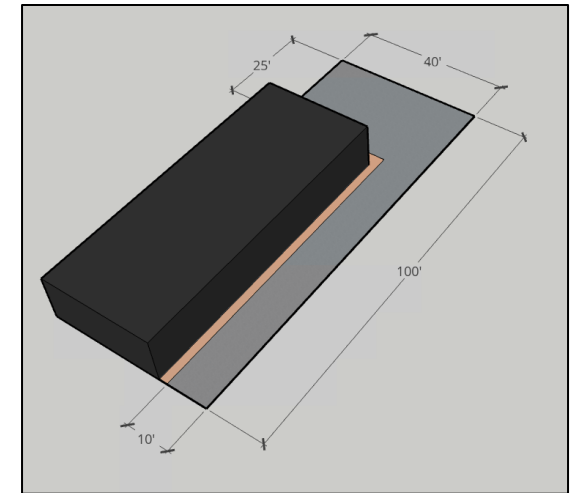
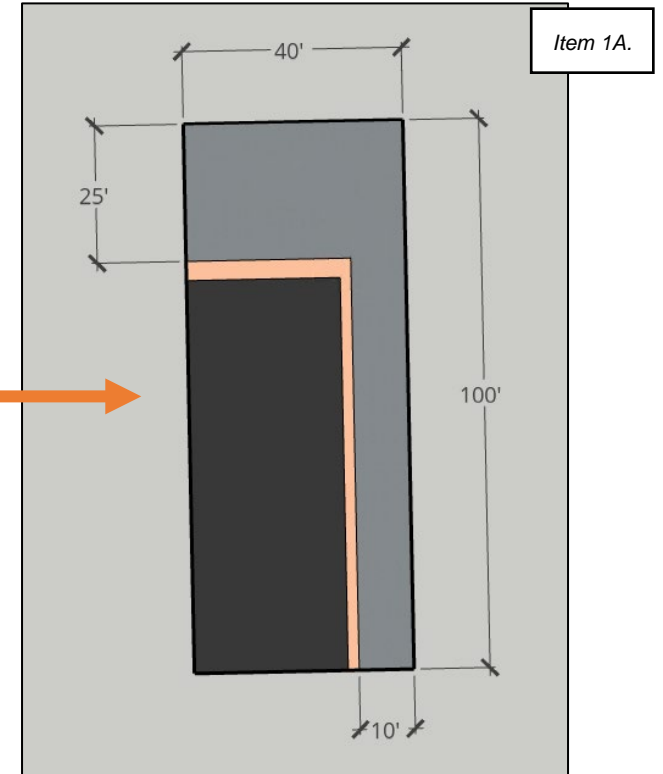

# Madeira Beach Land Development Regulations

## R-3 Zoning

Setbacks: Front Yard (20-25ft\*), Side Yard (5-10 ft\*), Rear Yard (CCCL or 25 ft\*)

Height: 44 ft

Floor Area Ratio: 0.55  
commercial use

\*based on use and width of lot

\*\*images based only on setbacks and height (not including landscape requirements and ISR)

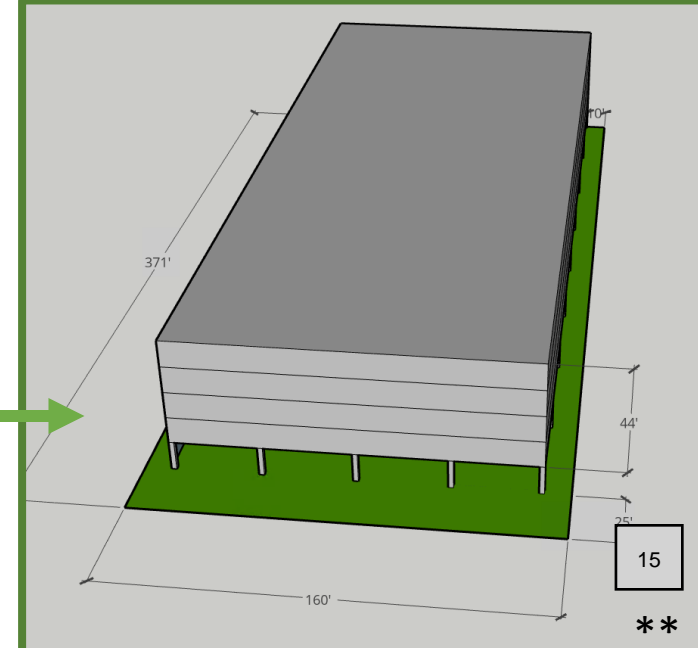
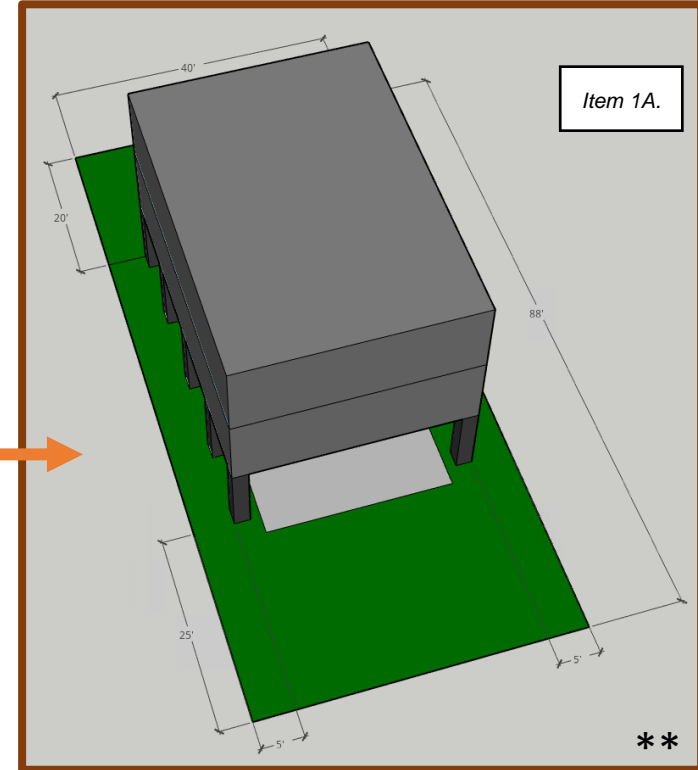
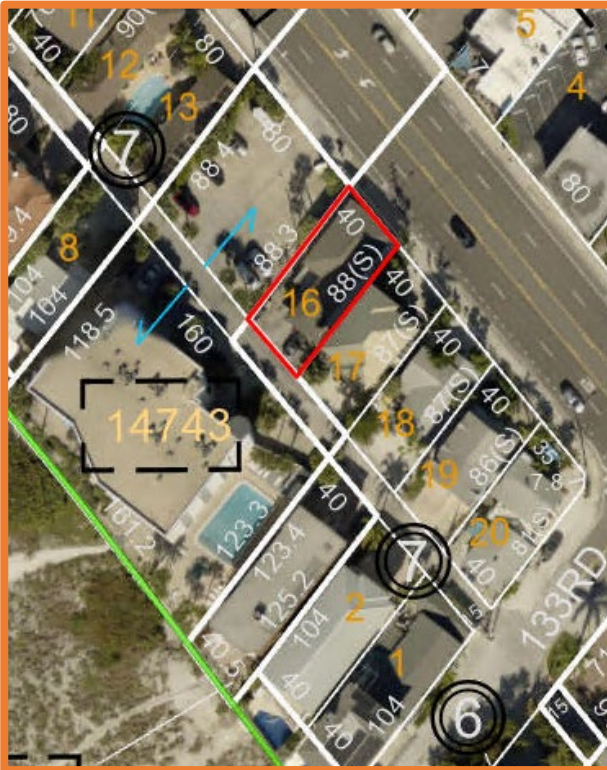

# Planning and Urban Design Principles

## The Activity Center Plan includes Design Policies and Principles based on:

- The City Comprehensive Plan which supports the special character and unique design features of John's Pass Village
- The Countywide Strategies Plan that requires certain design principles be addressed, including:
  - Location, size and density/intensity standards
  - Connectivity
  - Site orientation
  - Public realm enhancements
  - Ground floor design and use
  - Transition to neighborhoods





## Plan Adoption and Implementation Steps

01

Amend City's Comprehensive Plan to create Activity Center category Ordinance 2023-15

02

Initial City action to adopt Activity Center Plan Ordinance 2023-01  
Initial City action to amend Future Land Use map Ordinance 2023-02

03

CPA Meeting  
02/20/2024

Amend Countywide Plan to establish Activity Center on the Countywide Plan Map and the Land Use Strategy Map (PAC/PPC/CPA)

04

BOC Meeting  
03/13/2024

Final City action to adopt Activity Center Plan Ordinance 2023-01  
Final City action to amend Future Land Use map Ordinance 2023-02

05

Amend City's Land Development Code to establish Activity Center zoning districts

Administer and implement the Activity Center Plan



# Public Workshop

## John's Pass Village Activity Center Zoning



**Thursday 1/18/2024 1:00 PM-3:00 PM • Tuesday 1/23/2024 10:00 AM - 12:00 PM**

**Saturday 1/27/24 10:00 AM-12:00 PM**

**The Community Development Team will make a brief presentation and open workshop stations will follow. Three meetings are scheduled. All meetings have the same agenda.**

**Come to the one that works best for you.**

300 Municipal Drive Second Floor Commission Chambers

Refreshments will be served

# Boardwalk



- **Allowed Uses:** Commercial, Commercial Recreation, and Services
- **Intensity:** FAR 1.5
- **Density:** Residential 0 UPA and Temporary Lodging 0 UPA



# Commercial Core



- **Allowed Uses:** Residential, Temporary Lodging, and Commercial
- **Intensity:** FAR 2.0, and FAR 2.2-3.0 with Development Agreement
- **Density:** Residential 15 UPA, Temporary Lodging 60 UPA, and Temporary Lodging 75-100 UPA with Development Agreement

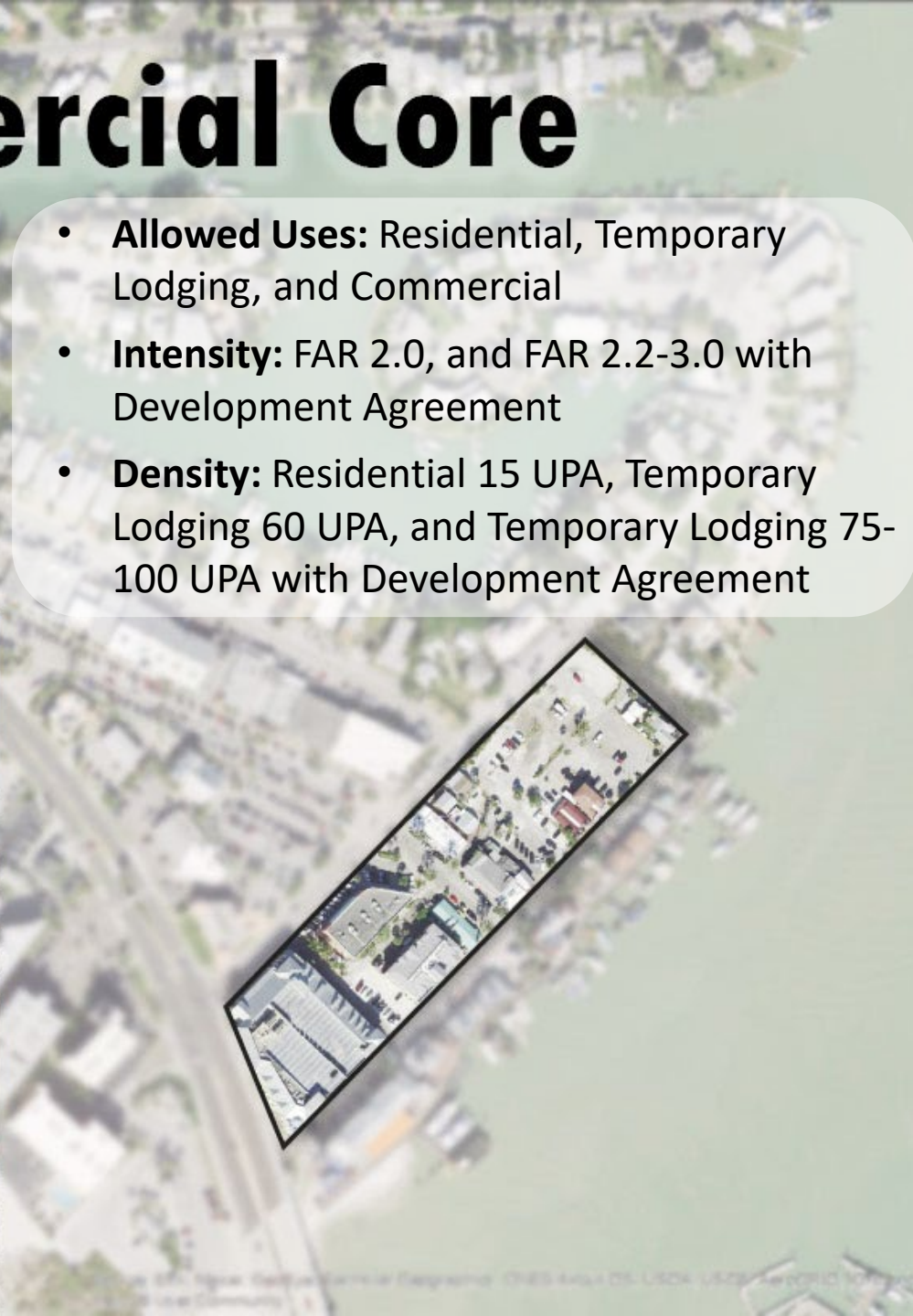

# John's Pass Resort

- **Allowed Uses:** Residential, Temporary Lodging, and Commercial only up to 20 percent of the building floor area
- **Intensity:** FAR 2.0, and FAR 2.2-2.5 with Development Agreement
- **Density:** Residential 18 UPA, Temporary Lodging 60 UPA, and Temporary Lodging 75-100 UPA with Development Agreement



# Low Intensity Mixed Use

- **Allowed Uses:** Residential, Temporary Lodging, and Commercial only up to 20 percent of the building floor area.
- **Intensity:** FAR 1.5, and 2.0 with Development Agreement
- **Density:** Residential 18 UPA, Temporary Lodging 40 UPA, and 60 UPA with Development Agreement.



# Traditional Village

- **Allowed Uses:** Residential, Temporary Lodging, and Commercial.
- **Intensity:** FAR 2.0
- **Density:** Residential 15 UPA, and Temporary Lodging 45 UPA



# Transitional

- **Allowed Uses:** retail and services, restaurant, office, temporary lodging, and residential units (Commercial only up to 20 percent of the building floor area on Westside of Gulf Boulevard).
- **Intensity:** FAR 1.5, and 2.0 FAR with Development Agreement
- **Density:** Residential 18 UPA, Temporary Lodging 50 UPA, and Temporary Lodging 75 UPA with Development Agreement





# John's Pass Village Activity Center Zoning Public Workshop

## What is this?

The City of Madeira Beach is in the process of a land use change at the county and city level. The city is required to create corresponding Zoning Districts with this land use change. Since the area for the John's Pass Village Activity Center is composed of different characteristics and uses, the area is subdivided into six different districts which will be codified into six new Zoning Districts. The new zoning is all contingent on the land use being adopted at the county and city level.

## What to do?

### **Grab a marker and fill out the SWOT analysis at each station.**

A SWOT analysis is a strategic planning technique to help identify Strengths, Weaknesses, Opportunities, and Threats. Keep your comments geared toward the area identified at the station and try to focus on issues that might be addressed through the Land Development Regulations and planning.

### **Your comments are valuable!**

Through the SWOT analysis we are not only gathering information for Zoning Districts, but also ideas for other amendments in the Land Development Regulations. All your comments are valuable and will be collected but know that some comments may not be directly associated with Zoning Districts (which is the current step in this process).

### **Fill out your paper and turn it in at the front door.**

On the back of this paper there is information on each new zoning district and areas to fill out. We want your input! Please fill these out and leave them at the front door after you have visited all the district stations.

### **Next steps.**

After these initial zoning meetings there will be Planning Commission and Board of Commissioner workshops before having other public workshops. We are early in the process of these zoning districts and encourage participation! Keep up to date with what is going on by visiting the City of Madeira Beach's social media pages and website.

## Comments and Suggestions

If you want to be contacted for future John's Pass Village Zoning public workshops provide your email:

Item 1B.

District	Current Zoning	Current Setbacks	Current Height (measured from DFE – typically first floor) *	Highest Existing Building in each district (stories from at grade, *each story can be about +/- 14 feet)
Boardwalk	C-2	Front: 20' Rear: None Side:5' one side	34 Feet	3 Stories
Commercial Core	C-1	Front: none Rear: 25' Side: 10' one side	34 Feet	6 Stories
Traditional Village	C-1	Front: none Rear: 25' Side: 10' one side	34 Feet	2 Stories
Low-Intensity Mixed Use	R-3	Front: 20-25' Rear: CCCL-25' Side:5-10'	44 feet	4 Stories and Roof Top Access
John's Pass Resort	R-3	Front: 20-25' Rear: CCCL-25' Side:5-10'	44 feet	6 Stories
Transitional	R-3 (west), C-3 and C-4 (east)	R-3: Front: 20-25' Rear: CCCL-25' Side:5-10' C-3: Front: 25' Rear: 10-18' Side: 10-20' C-4: Front: 25' Rear: 18' Side: 10-20'	44 feet (west), 34 to 44 feet (east)	7 Stories

Height is measured from Design Flood Elevation (DFE) which is Base Flood Elevation (BFE) plus 4.4 feet. This typically means measurement begins at the bottom of the second story. A story can vary in height but assume an average complete floor or story height is 14 feet.

District	Proposed Front Setback and Use	Proposed Side Setback and Use	Proposed Rear Setback and Use	Stories from at grade	Additional Standards
Boardwalk					
Commercial Core					
Traditional Village					
Low-Intensity Mixed Use					
John's Pass Resort					
Transitional					

Additional Comments: