

AGENDA



CITY OF HOPEWELL

Hopewell, Virginia 23860

AGENDA

(804) 541-2408
www.hopewellva.gov
info@hopewellva.gov
cityclerk@hopewellva.gov

CITY COUNCIL
John B. Partin, Jr., Mayor, Ward #3
Jasmine E. Gore, Vice Mayor, Ward #4
Rita Joyner, Councilor, Ward #1
Michael B. Harris, Councilor, Ward #2
Janice B. Denton, Councilor, Ward #5
Brenda S. Pelham, Councilor, Ward #6
Dominic R. Holloway, Sr., Councilor, Ward #7

Dr. Concetta Manker, City Manager
Danielle Smith, City Attorney
Brittani Williams, City Clerk
Bridetta Williams, Deputy Clerk

April 23, 2024

REGULAR MEETING

Closed Meeting- 6:00 PM
Work Session-7:00pm
Regular Meeting- 7:30pm

6:00 p.m.

Call to order, roll call, and welcome to visitors

CLOSED MEETING

SUGGESTED MOTION: Move to go into closed meeting pursuant to Va. Code Section § 2.2-3711 (A) (1) to discuss and consider personnel matters, including board and commission appointments; the assignment and performance of specific appointee and employees of City Council, and VA. Code section § 2.2-3711 (a)(29) for discussion of the award of public contract involving the expenditure of public funds, including interviews of bidders, offerors, and discussion of the terms or scope of such contract, where discussion in an open session would adversely affect the bargaining position or negotiating strategy of the public body, and to the extent such discussion will be aided thereby

Roll Call

RECONVENE OPEN MEETING

CERTIFICATION PURSUANT TO VIRGINIA CODE § 2.2-3712 (D): Were only public business matters (1) lawfully exempted from open-meeting requirements and (2) identified in the closed-meeting motion discussed in closed meeting?

REGULAR MEETING

7:30 p.m. Call to order, roll call, and welcome to visitors

Prayer by Evangelist Wright, followed by the Pledge of Allegiance to the Flag of the United States of America led by Mayor Partin.

SUGGESTED MOTION: To amend/adopt Regular Meeting Agenda Roll Call

CONSENT AGENDA

All matters listed under the Consent Agenda are considered routine by Council and will be approved or received by one motion in the form listed. Items may be removed from the Consent Agenda for discussion under the regular agenda at the request of any Councilor.

- C-1 **Minutes:** 3-26-24, 4-11-24
- C-2 **Pending List:** December 14, 2023
- C-3 **Information for Council Review:**
- C-4 **Personnel Change Report & Financial Report:**
- C-5 **Public Hearing Announcements:**
- C-6 **Routine Approval of Work Sessions:**
- C-7 **Ordinances on Second & Final Reading:**
- C-8 **Routine Grant Approval:**

SUGGESTED MOTION: To amend/adopt consent agenda

INFORMATION/PRESENTATIONS

1. **Freedman Point – Chris Ward, Director of Development and Kathy Osterman, Director of Freedman Point, Woda Cooper Group**

COMMUNICATIONS FROM CITIZENS

CITY CLERK: *A Communication from Citizens period, limited in total time to 30 minutes, is part of the Order of Business at each regular Council meeting. All persons addressing Council shall approach the microphone, give name and, if they reside in Hopewell, their ward number, and limit comments to three minutes. No one is permitted to speak on any item scheduled for consideration on regular agenda of the meeting. All remarks shall be addressed to the Council as a body, any questions must be asked through the presiding officer. Any person who makes personal, impertinent, abusive, or slanderous statements, or incites disorderly conduct in Council Chambers, may be barred by the mayor from further audience before Council and removed, subject to appeal to a majority of Council (See Rules 405 and 406)*

PUBLIC HEARING

CITY CLERK: *All persons addressing Council shall step to the microphone, give name and **If** they reside in Hopewell, their ward number, and limit comments to three minutes. No one may address council more than once per meeting, unless granted permission by the presiding officer. Speakers address council as a body, not individual councilors. Questions are asked of councilors and staff through the presiding officer. Any person who makes personal, impertinent, abusive, or slanderous statements, or incites disorderly conduct in the council chamber may be reprimanded by the presiding officer, and removed from the meeting upon a majority vote of councilors present, excluding any councilor who is the subject of the motion. (See Rules 405 and 406)*

REGULAR BUSINESS

- R1 – Conditional Use Permit for Maryland Ave – Chris Ward, Director of Development**
- R2 - Conditional Use Permit for Crescent Ave – Chris Ward, Director of Development**
- R3 - Conditional Use Permit for Boston St – Chris Ward, Director of Development**
- R4 - School’s Appropriation – Russell Branson, Interim Finance Director**
- R5 - Virginia Department of Conversation and Recreation Trails Program Grant – Tabitha Martinez, Parks and Recreation Director**

Reports of City Manager: Collective Bargaining

Reports of City Attorney:

Reports of City Clerk:

Councilors Pending Request

CCR1 – Amend purpose of the Keep Hopewell Beautiful Commission to include tracking environment violations, approved advocacy and legislative recommendations – Vice Mayor Gore

Presentations from Boards and Commission

Other Council Communications

BOARD/COMMISSION VACANCIES

Architectural Review Board – 3 Vacancies
Downtown Design Review – 2 Vacancies
Board of Building Code and Fire Prevention Code Appeals – 5 Vacancies
Keep Hopewell Beautiful – 1 Vacancy
Recreation and Parks – 4 Vacancies
Library Board – 1 Vacancies
DSS – 7 Vacancies
Healthy Families – 3 Vacancies (3 pending applications)
District 19 – 2 Vacancies
Towing Advisory Board – 4 Vacancies (3 Tow Operators, 1 Civilian)

Adjournment

**CLOSED
MEETING**

RECONVENE OPEN MEETING

REGULAR MEETING

CONSENT AGENDA

C-1

MINUTES OF THE March 26, 2024 CITY COUNCIL REGULAR MEETING

A REGULAR meeting of the Hopewell City Council was held on Tuesday March 26, 2024 at 6:00 p.m.

PRESENT: John B. Partin, Mayor
Jasmine Gore, Vice Mayor
Rita Joyner, Councilor
Michael Harris, Councilor
Janice Denton, Councilor
Brenda Pelham, Councilor
Dominic Holloway, Councilor (Arrived Late)

Councilor Joyner makes a motion to allow Councilor Harris to participate remotely. Councilor Pelham seconds the motion.

ROLL CALL

Councilor Holloway-	(Absent)
Councilor Joyner-	Yes
Councilor Harris-	(Abstain)
Mayor Partin-	Yes
Vice Mayor Gore-	Yes
Council Denton-	Yes
Councilor Pelham-	Yes

Motion Passes 5-0

CLOSED MEETING:

Councilor Joyner makes a motion to go into closed meeting pursuant to Va. Code Section §2.2-3711 (A) (I) to discuss and consider personnel matters, including board and commission appointments; the assignment and performance of specific appointee and employees of City Council, and VA. Code section §2.2-3711 (a)(29) for discussion of the award of public contract involving the expenditure of public funds, including interviews of bidders, offerors, and discussion of the terms or scope of such contract, where discussion in an open session would adversely affect the bargaining position or negotiating strategy of the public body, and to the extent such discussion will be aided thereby, Mayor Partin seconds the motion.

ROLL CALL

Councilor Holloway-	(Absent)
Councilor Joyner-	Yes
Councilor Harris-	Yes
Mayor Partin-	Yes
Vice Mayor Gore-	Yes
Council Denton-	Yes
Councilor Pelham-	Yes

Motion Passes 6-0

Reconvene Open Meeting

Councilor Holloway makes a motion to reconvene open meeting. Councilor Denton seconds the motion.

ROLL CALL

Councilor Holloway-	Yes
Councilor Joyner-	Yes
Councilor Harris-	(Absent)
Mayor Partin-	Yes
Vice Mayor Gore-	Yes
Council Denton-	Yes
Councilor Pelham-	Yes

Motion Passes 6-0

Councilor Denton makes a motion to appoint Paul Reynolds to the Board of Zoning Appeals and Frederich Walker and Ms. Michelle Bennett to the Hopewell/Prince George Healthy Families Board. Mayor Partin seconds the motion

ROLL CALL

Councilor Holloway-	(Abstain)
Councilor Joyner-	Yes
Councilor Harris-	(Absent)
Mayor Partin-	Yes
Vice Mayor Gore-	Yes
Council Denton-	Yes
Councilor Pelham-	Yes

Motion Passes 5-0

Councilor Denton makes a motion to appoint Dr. Rip Ballou to the Hopewell Redevelopment Housing Authority. Mayor Partin seconds the motion.

Vice Mayor states she wants to annotate for her constituents, she will be voting No on this Motion because she believes we should have a meeting with the HRHA regarding some concerns that were raised and feels comfortable having that addressed before a vote to appoint another member there's nothing personal about the applicant.

ROLL CALL

Councilor Holloway-	Yes (Silent)
Councilor Joyner-	Yes
Councilor Harris-	Yes (Silent)
Mayor Partin-	Yes
Vice Mayor Gore-	No
Council Denton-	Yes
Councilor Pelham-	Yes

Motion Passes 6-1

CERTIFICATION:

CERTIFICATION PURSUANT TO VIRGINIA CODE §2.2-3712 (D): Were only public business matters (1) lawfully exempted from open-meeting requirements and (2) identified in the closed-meeting motion discussed in closed meeting?

ROLL CALL

Councilor Holloway-	Yes
Councilor Joyner-	Yes
Councilor Harris-	(Absent)
Mayor Partin-	Yes
Vice Mayor Gore-	Yes
Council Denton-	Yes
Councilor Pelham-	Yes

Motion Passes 6-0

REGULAR MEETING

Mayor Partin calls the Regular Meeting to order

PRESENT:

John B. Partin, Mayor
Jasmine Gore, Vice Mayor
Rita Joyner, Councilor
Michael Harris, Councilor
Janice Denton, Councilor
Brenda Pelham, Councilor
Dominic Holloway, Councilor

Prayer by Pastor Collier, followed by the Pledge of Allegiance to the flag led by Councilor Holloway

Councilor Holloway makes a motion to adopt the Regular meeting Agenda. Mayor Partin seconds the motion.

ROLL CALL

Councilor Holloway-	Yes
Councilor Joyner-	Yes
Councilor Harris-	(Absent)
Mayor Partin-	Yes
Vice Mayor Gore-	Yes
Council Denton-	Yes
Councilor Pelham-	Yes

Motion Passes 6-0

CONSENT AGENDA

Councilor Joyner makes a motion to adopt the Consent Agenda. Mayor Partin seconds the motion.

Councilor Denton calls attention to the agenda C1 Minutes, March 12th and the 14th. In your Foia packet, there were five other sets of minutes from 2020, not noted in the consent agenda. So, when I looked at them, I noticed that the current clerk signed them and in 2020, she was not with us. So, it raised some questions in my mind. I know having been on council in 2020, I would get cooperation from the other council our minutes were a mess. We were missing some. I'm not saying we were missing these six or seven weeks of sets of minutes but I'm not sure and would like to ask our city attorney if this is in our official binder of minutes for the City and we have some discrepancies. Is there a proper way if we don't we are going back and make these corrections. Is there a proper way if the old or the original city clerk is not available to sign these minutes for the record that we put that name and then signed by Brittani as the acting clerk? It seems to me these are the official book of the minutes for our city. We should be very particular about how we record them in that book. This is leaving some error of judgement. Atty Smith states because we do have so many clerks that have taken the seat since 2020, the proper thing to do would be to have the mayor who was serving in 2020 sign the minutes, backdating them to the effective date of when they reflect the minutes of the city council meeting. So, since the clerk who was presiding over the meeting is no longer available, the proper thing to do would be to have the mayor who was serving at the time, sign the minutes. Atty Smith notes that what makes the minutes' official is the signature of the chairperson that was presiding over the meeting that was either the mayor or the Vice Mayor. So, it would be proper to have the mayor or whoever was presiding at the time or city council person whoever was the chairperson sign the minutes to make them official. The clerk's signature would be nice to have essentially, but because we don't have that clerk here anymore, what makes the minutes' official is the signature of the chairperson which is usually the mayor or the vice mayor. As long as the signatures reflect the mayor at the time or the vice mayor at the time we're okay. Councilor Denton makes a friendly amendment to remove C-1.

Councilor Pelham adds that there should be a separate meeting maybe to have some idea when she's going to catch up with the old minutes. Some way we can gather a time line of how many minutes we have left, from the old minutes four years ago. We need to get a timeline when she can finish them. Get one maybe the clerk or the deputy clerk to exclusively to work on that so we can finish them. Councilor Holloway state this is something that was previously brought up to council and the vice mayor who had given answers to this when she was training the city clerk. He informs Council that there are actual rules to correct the old minutes that need to be adopted and believes it includes the council voting on it. Councilor Holloway states as the city attorney had stated, what we had read and looked at was appropriate. He then notes some area of discrepancies from previous years and some reasons for missing minutes. Councilor Joyner asks about the number of missing minutes there are currently and Vice Mayor Gore gives some information as to the office where the meeting minutes are located and stored. She then asks Madam Deputy Clerk to give a brief update. The Deputy Clerk gives a status report of the current and back log of meeting minutes.

ROLL CALL

Councilor Holloway-	Yes
Councilor Joyner-	Yes
Councilor Harris-	Yes
Mayor Partin-	Yes
Vice Mayor Gore-	Yes
Council Denton-	Yes
Councilor Pelham-	Yes

Motion Passes 7-0

INFORMATION/ PRESENTATIONS

- 1. City's Access to Credit-James Sanderson, Financial Advisor.** Russell Branson introduces James Sanderson and his presentation tonight. Mr.

Sanderson talks about the framework the city should have in place to ask banks to loan money. He describes several steps over the next few months which are completing the Audits, financial stability, demonstrating processes and procedures to be put in place to ensure future and timely reporting, potential lending options for the City, rating Agency interaction and the benefits and challenges of financial structures.

COMMUNICATIONS FROM CITIZENS

1. **Sharah' Fuller**-Talks about what was discussed among the council members at the previous council meeting. Ms. Fuller asks the city council to come out for the Community Walk taking place in Hopewell and states events that will be there. She informs there is an outage on the seventh street bridge she states half of the bridge is out of lights.
2. **Tara James**- introduced herself to council stating she is a community health worker, working in Hopewell. She goes on the tell she works to decrease disparities among people with social determinants of health in the City. States again she wanted to introduce herself and she will be reaching out for council to provide her with information on how she can help the city and citizens of the city. She concludes she works for Central Va Health Services and talks a little about the company and location information.

PUBLIC HEARING

PH1- COUNCIL AGENDA ITEM TITLE: Public Hearing and Second Reading to Amend Zoning Ordinance Articles I (Definitions), IX-A (Downtown Central Business District, BI), and XIV-B (Tourist/Historic District, TH-1), and add Article XXIII (Historic Preservation)
-Chris Ward, Director of Development. Kelly Davis introduces herself to council. Ms. Davis outlines the area highlighted and speaks to the original intent, which was to consolidate two review bodies, the ARB and DDRC. To do that, we pulled out some of the sections to a new article for historic preservation. The

zoning ordinance amendment proposes text changes to improve administration of architectural review requirements for the local historic districts and also addresses economic development and regulatory improvements. Staff recommends approval of this zoning ordinance amendment. This is the second reading so we are recommending action take place after the public hearing. She is asking for an effective date of June 1st to allow time to vote on the consolidation of those bodies, appoint the members of the DDRC to the ARB, and allow staff time to get the correct forms in place to be ready for the June meetings.

Councilor Joyner makes a motion to approve the zoning ordinance submitted for article one definitions downtown central business district B2, B1 and then the tourist historic district on second reading the exact statement and the new historic preservation article 23. Councilor Denton seconds the motion.

ROLL CALL

Councilor Holloway-	Yes
Councilor Joyner-	Yes
Councilor Harris-	Yes
Mayor Partin-	Yes
Vice Mayor Gore-	Yes
Council Denton-	Yes
Councilor Pelham-	Yes

Motion Passes 7-0

REGULAR BUSINESS

R-1- Proposed Towing Ordinance- Chief Taylor, Chief of Police. Chief Taylor states we are here for the proposal of the Tow Truck ordinance and requesting your approval. The purpose for this ordinance is to regulate the contracts that the city of Hopewell maintains through the police department to maintain proper

administration of the towing companies in emergency situations.

Vice Mayor Gore makes a motion to adopt the resolution of the creation of a towing advisory board for the city of Hopewell with the amendments that the membership of the board shall consist of no less than three (3) no more than seven (7) members for two (2) year terms. Councilor Holloway seconds the motion.

ROLL CALL

Councilor Holloway-	Yes
Councilor Joyner-	Yes
Councilor Harris-	Yes
Mayor Partin-	Yes
Vice Mayor Gore-	Yes
Council Denton-	(Absent)
Councilor Pelham-	Yes

Motion Passes 6-0

Vice Mayor Gore makes a motion to approve the Towing Ordinance as provided. Mayor Partin seconds the motion.

ROLL CALL

Councilor Holloway-	Yes
Councilor Joyner-	Yes
Councilor Harris-	Yes
Mayor Partin-	Yes
Vice Mayor Gore-	Yes
Council Denton-	Yes
Councilor Pelham-	Yes

Motion Passes 6-0

R-2- Strategic Economic Development Plan Request- Charles Bennett, Economic Development Director. Mr. Bennett presents an updated strategic plan for economic development for the city of Hopewell. In the packet is a draft document that will be used as a foundation. Mr. Bennett discusses the steps to progress the plan in working together with the EDA and Council in the coming months.

Councilor Pelham makes the motion to charge the City Manager and Director of Economic Development and Tourism to work with the Hopewell EDA to prepare and update a strategic plan for presentation to city council and to have the draft plan to council by the June 1, 2024. Councilor Joyner seconds the motion.

ROLL CALL

Councilor Holloway-	Yes
Councilor Joyner-	Yes
Councilor Harris-	Yes
Mayor Partin-	Yes
Vice Mayor Gore-	Yes
Council Denton-	Yes
Councilor Pelham-	Yes

Motion Passes 7-0

Vice Mayor Gore makes a motion to extend the meeting until CCR1 is complete. Councilor Pelham seconds the motion.

ROLL CALL

Councilor Holloway-	Yes
Councilor Joyner-	Yes
Councilor Harris-	Yes
Mayor Partin-	Yes
Vice Mayor Gore-	Yes
Councilor Denton-	Yes

Councilor Pelham- Yes

Motion Passes 7-0

Councilor Denton speaks on past meetings having a CAF presented for Councilor Request items. She states this particular CCR1 item, there was not a CAF presented. Councilor Denton states we are not following our rules and would like to see this item postponed and done properly. Councilor Pelham states the CCR1 item was postponed from the last Regular meeting and majority of Council voted at that time to move the item to the next regular meeting, which is today. Councilor Holloway and Vice Mayor Gore agreed the item in discussion was on the previous council meeting agenda and it was postponed two weeks, until the next regular council meeting of today.

CCR1- Protection of Legitimate Political Activities of Employees and

Restrictions- Councilor Pelham. Councilor Pelham presents an item that covers state statute 15.2-1512.2 of the state code of Virginia. She talks about the code meaning to employees of a city politically running for a particular city council office. The attorney general issued several opinions on the case that I found. Councilor Pelham names examples in other cities in Virginia along with a related case. She states in all the cases show that what is recommended and determined if you have full time employment with the city, you either have to resign your employment to run for city council or retire. She goes further that she wants to align our ordinance with the state code and coming before city council to do so. Councilor Pelham defers the council body to the ordinance in the back of their folders and gives information in the area of campaigning public safety.

Councilor Pelham makes a motion to adopt the ordinance as drafted. Councilor Holloway seconds the motion.

There was further discussion with council in regard to the ordinance and political comment, and statutes. Councilor Joyner asks if the ordinance was written based on the VA Code Statute.

Councilor Holloway makes a motion to call for the vote. Vice Mayor seconds the motion.

ROLL CALL

Councilor Holloway-	Yes
Councilor Joyner-	No
Councilor Harris-	Yes
Mayor Partin-	No
Vice Mayor Gore-	Yes
Council Denton-	No
Councilor Pelham-	Yes

Motion Passes 4-3

Mayor Partin states meeting is automatically adjourned, Councilor Holloway states there was a motion on the floor. Mics were turned off.

Mic's were turned back on for the motion on the floor.

Councilor Pelham makes a motion to adopt the ordinance as drafted. Councilor Holloway seconds the motion.

ROLL CALL

Councilor Holloway-	Yes
Councilor Joyner-	No
Councilor Harris-	Yes
Mayor Partin-	No
Vice Mayor Gore-	Yes
Council Denton-	No
Councilor Pelham-	Yes

Motion Passes 4-3

ADJOURNMENT:

Vice Mayor Gore motions to adjourn,

Yes- 7

No- 0

Respectfully Submitted,

Johnny Partin, Mayor

Brittani Williams, City Clerk

MINUTES OF THE APRIL 11, 2024 CITY COUNCIL SPECIAL MEETING

A SPECIAL meeting of the Hopewell City Council was held on Thursday April 11, 2024 at 6:00 p.m.

PRESENT: John B. Partin, Mayor
Jasmine Gore, Vice Mayor (Arrived Late)
Rita Joyner, Councilor
Michael Harris, Councilor (Virtual)
Janice Denton, Councilor
Brenda Pelham, Councilor
Dominic Holloway, Councilor (Arrived Late)

Councilor Joyner makes a motion to allow Councilor Harris to participate remotely. Mayor Partin seconds the motion.

ROLL CALL	Mayor Partin-	Yes
	Vice Mayor Gore-	Absent
	Councilor Joyner-	Yes
	Councilor Harris-	Abstain
	Councilor Denton-	Yes
	Councilor Pelham-	Yes
	Councilor Holloway-	Absent

Motion Passes 4-0

Dr. Manker opens the meeting to state this meeting is for proposed taxes. The goal of tonight is to have a discussion and conversation about which taxes council will choose to consider, and on April 16th there will be a tax resolution set so treasurer's

office can get the bills sent out on time. She then passes the floor to Russel to go over his presentation. Russ discusses the bas revenue and states they are talking about capital and how to fund capital moving forward. He goes over budget needs beginning with capital. He states \$6.9M has been identified as needed for capital in FY25. Only %618,000 funded by forecast revenues. He states HRWTP will be funded with rate revenues from industry partners and city sewer. He goes over the reserves and mentions there is no funding increased in general fund in forecast for revenue. He speaks to HRWTP, sewer, and other funds that were also presented to council in his presentation. He moves on to discuss priority capital needs and mentions the city needs \$2.4M of General fund revenues to fund the department, identified priority capital requests. He goes over in detail all priority requests in each department head. He came up with the numbers provided by speaking to the heads and determining what they can do without and what they need the most. He goes over funding options with council, mentioning raising taxes. He goes over the numbers for the certain areas where taxes could be raised. He mentions real estate, personal property, machinery and tools, food and beverage, lodging, and institute cigarette tax. He states storm water fees and their increases as well. He speaks about operating expenses, if they don't want to raise taxes, and he lets council know it will be hard to do that because there are not a lot of places to cut money to avoid raising taxes. Mr. Branson speaks about real estate and states in 2004 tax rate was \$1.20, and since then it had gone down. He then speaks about the property tax from 2006 to current. Machinery and tools tax rate he mentions was \$3.03 in 1995 and was last raised in 2022. Mr. Branson goes into further detail about surrounding jurisdictions and tax comparison. For real estate he states \$1.20 puts Hopewell in line with neighboring cities. He goes into further detail for machinery and tools, personal property, and other taxes. He explains other localities and Hopewell for all the above mentioned. He states they have cut out the cost general fund budget of \$618,000. They have storm water fees which he believes should be increased, and he mentions increased taxes and reduced operations will vary based on the tax rates that council chooses to implement. He provides a graph for council in his presentation to help show how the increases could work for Hopewell. Councilor Pelham asks is there a list of possible reductions, Mr. Branson states he currently does not have that. He recommends storm water fees, cigarette tax, lodging tax, food and beverage tax, real estate tax, personal property tax, and machinery and tools tax possible increases. He states a lot of capital has carried over from year to year without knowing if they had enough money to do so, so it comes over as a use

of surplus. He states this discussion is to really decide what they absolutely need to do to increase revenue in the city.

Councilor Denton states they are already committed for certain projects with the state of VA, she asks is that the 2.4M that is needed, Mr. Campbell, the public works director speaks to that question and states yes that is what they need. They are projects that were already approved with contracts and money has already been allocated by the state. Mr. Campbell goes further into detail about the pending projects and their duty to get them done.

Councilor Pelham asks how many projects did council approve by resolution, is it 1.6 or 2.4? Mr. Campbell responds that it is 1.6.

Councilor Joyner asks about the roads falling in and is that a project they are funding? Mr. Campbell stated it is already part of his PMO and it is a working progress.

Councilor Pelham asks to include projects in ward 6, but she sees no streets, Wall St. and Pine Ave. asking are they a part of his plan. Mr. Campbell stated he does not believe it is included because it would be part of the shared projects.

Councilor Denton asks Mr. Campbell was he still working with the group out of Washington DC. Mr. Campbell stated yes he is, they have 2 projects and a separate set of projects being combined with an EPA grant.

Mayor Partin asks Dr. Manker and Mr. Branson, some projects show as 3 year projects have they looked at trying to the same thing with the community center to expand it to three years. Mr. Branson stated it will likely be broken into a few years. He then asks about the river walk breaking it into two years of funding. Mr. Branson stated he thinks that is very possible. He then asks with storm water fee, are there numbers to see what it would look like to pull the storm water fees out, Mr. Branson says he currently does not have a number for that off hand.

Councilor Denton asks for clarity, the tax rates that have been recommended starting with storm water fees all the way down, if they do just that can they meet the 2.4 million and it would cover the commitments to the public works.

Council now goes through the council action recommendations by taking a consensus on each item.

Council begins with cigarette tax, Councilor Holloway states he is not in agreement with the amount of increase for cigarette tax increase going up that

high. Vice Mayor Gore states she already knows how she will vote so she is not saying much, but a decision needs to be made tonight because they only have 5 days to come up with an approval. Councilor Joyner states 40 cent seems like a lot for one pack and maybe pull the amount down, but she has no problem with the tax increase. City Attorney Ms. Smith gives a number for neighboring localities, stating Petersburg cigarette tax in 2021 it was 90 cents per pack, Richmond was 50 cents per pack, Colonial Heights is 35 cents per pack, the range is 2021 was from 4.5 cents per pack to 1.26 cents per pack. Mayor Partin asks is there a consensus for cigarette tax, there was a consensus. They move on to storm water fees, there was a majority consensus. Councilor Holloway states these tax increases are ridiculous and the low income households are not considered. He states it is inconsiderate of the citizens. He states taxes add up and he does not believe it is appropriate. Councilor Harris states he feels the same as Councilor Holloway, however it is in favor of raising it, but how much is in question. Vice Mayor Gore asks for clarification, were there 4 or 5 who agreed, the answer is 5. For storm water there is a majority. Next is lodging, the consensus for lodging was to raise it 2 percent instead of 1 percent. For food and beverage, consensus was not agreed. Councilor Holloway speaks to the food and beverage stating if you agreed to jump the lodging from 1 to 2 percent it will make up for the food and beverage to keep the tax the same. Vice Mayor Gore states she agrees with Councilor Holloway, inflation for food is already a lot, especially for those who are not receiving assistance. She is fine with any of the other taxes being raised, however, not for food and beverage. The consensus for food and beverage is to not raise it and have it as no change. Real Estate consensus was yes to raising, however, they would like to look at other options for the amount. Councilor Joyner state citizens haven't seen any changes for where their taxes are going, no roads are getting better so they believe their tax dollars are being wasted. Councilor Holloway states he knows the complications of how upset 80 percent of the city was when the assessments came out last year. He thinks they should find some other way; \$70 dollars adds up. He would like to see more consideration for the citizens of Hopewell. He would rather see 40 cents on cigarettes then increase property tax. Vice Mayor Gore states they are not the why for why they are here with this discussion. She states she is not voting for an increase. Her position remains the same for the last two years, to look at delinquent payments, to find out the gaps for that. There are businesses in the city that make up a large chunk of tax dollars that are missing that are still in operation. She says nothing has been done to shut them down or find them accountable for paying their fair share. The lack of management

and oversight of admin these past few years has also been an issue. The outcome for real estate was there was a consensus but they prefer to look at options of how much to increase it. Councilor Holloway states it is absolute no for him. He states it is correct that there is more money needed, but it's from mismanagement of funds, and now the necessary things to get the city back on track are just getting put into place. There are so many other things that can be fixed within the departments to avoid putting any more taxes on the citizens. He states we can re-do and re-think how to increase revenue without raising taxes on our citizens. Councilor Harris states taxes is something that is hated by everyone all the time. He agrees with everyone, but he doesn't agree with raising taxes in regard to how they are doing it. His concern is how do you do it in the interest of our citizens. He states if there is a way to do it without hurting the citizens, he wishes someone would show him. For mismanagement for what was before, he states he can't speak to that, but if it did occur it needs to be fixed. Vice Mayor Gore states there is cost for the city but there is also cost for governing. Vice Mayor Gore states she is going to call a special meeting for delinquent payments, contracts, and to look at the lapse in business licenses, she asks is there any objections. The consensus was to have the meeting and Dr. Manker stated she will send an email to discuss a time to have the meeting. Councilor Pelham asks what would it look like if every department reduced their budget 10 percent. Dr. Manker will get that information to council. Dr. Manker makes sure directive is to bring back storm water, cigarettes, lodging, and options for real estate taxes. The consensus for personal property and machinery and tools was to make no changes. Councilor Denton states she would like for one year her last year that everyone try to make this as easy as possible, every time there has been a budget for last 7 years they have been at each other's throat. Certain things are special to one that's not special to another. They have cut the budget, sent back, cut it 10 percent, gone line by line through he entire budget, and she feels this year they there is a group of professionals to help with this budget, they are smarter and know more than they do. She states lets listen to the Robert Bobb Group because they are impartial. She states she would like to take their lead and she asks council to think about and don't go back in the past, what happens years ago is over. She states they need to move forward, not backwards. Mayor Partin asks would Councilor Denton like to make a motion to adjourn. Councilor Denton states she did ask for one. Mayor Partin asks for a roll call.

ROLL CALL

Mayor Partin-	Yes
Vice Mayor Gore-	No
Councilor Joyner-	Yes
Councilor Harris-	No
Councilor Denton-	Yes
Councilor Pelham-	No
Councilor Holloway-	No

Motion Fails 3-4

Councilor Pelham states when you hire a contractor, they do just that, they come in to provide guidance, they do not know the citizens of the city. They do not consider their households; they are focusing only on numbers. It is up to council to provide empathy and consider the citizens of their city. She states if they got along 7 years ago, they may not be here today. She considers constituents and that is her top priority. She thanks the Robert Bobb Group.

Vice Mayor Gore states she thanks city manager for the transparency of the needs of the city. She states this goes back to lack of governing, and trusting staff is what got the city here, and when they attempt to verbalize its always looked at as negative. She states false information being spread across the city is because of comments previously said. She states dog whistles won't help to having a positive budget period.

Councilor Holloway gives all respect to the Robert Bobb Group, but he states these things brought during a budget cycle are suggestions that they can choose or not choose to accept. He states this is not the only direction they can go and different things they can revisit. He states to the citizens into consideration and look at departments as a way of re-budgeting. He states everyone to call their representatives and give their opinions.

ADJOURNMENT:

Councilor Holloway motions to adjourn,

Yes- 7

No- 0

Respectfully Submitted,

Johnny Partin, Mayor

Brittani Williams, City Clerk

C-2



CITY OF HOPEWELL

COUNCILOR PENDING LIST



<u>REQUEST</u>	<u>REQUESTOR</u>	<u>DATE</u>	<u>NOTES</u>
Delinquent Funds	Jasmine Gore	12/14/2023	City Manager
Housing Commission	Jasmine Gore	12/14/2023	CCR - Hold
Poet Lareate	Brenda Pelham & Jasmine Gore	12/14/2023	CCR (Defer to Pelham)
Beacon Theater LLC	Jasmine Gore	12/14/2023	City Manager
Crisis Support	Jasmine Gore	12/14/2023	City Manager
City Human Resource Policy	Brenda Pelham	12/14/2023	HOLD
Business License Policy	Jasmine Gore	12/14/2023	HOLD
City Credit Card Policy	Brenda Pelham	12/14/2023	CCR
RFP For Financial Services	Councilor Joyner	12/14/2023	HOLD

INFORMATION/
PRESENTATIONS



CITY OF HOPEWELL CITY COUNCIL ACTION FORM

Strategic Operating Plan Vision Theme:

- Civic Engagement
- Culture & Recreation
- Economic Development
- Education
- Housing
- Safe & Healthy Environment
- None (Does not apply)

Order of Business:

- Consent Agenda
- Public Hearing
- Presentation-Boards/Commissions
- Unfinished Business
- Citizen/Councilor Request
- Regular Business
- Reports of Council Committees

Action:

- Approve and File
- Take Appropriate Action
- Receive & File (no motion required)
- Approve Ordinance 1st Reading
- Approve Ordinance 2nd Reading
- Set a Public Hearing
- Approve on Emergency Measure

COUNCIL AGENDA ITEM TITLE: Presentation about Woda Cooper Companies' rehabilitation efforts at Friedman Point located at 311 E. Cawson St.

ISSUE: Kathy Osterman, Regional Vice President of Woda Cooper Companies, will present the company's plans to rehabilitate the Freedman Point apartments.

RECOMMENDATION: No action is requested.

TIMING:

BACKGROUND: Woda Cooper wants to make sure city leadership understands that the company is aware of several issues and they are actively working to rectify the issues.

ENCLOSED DOCUMENTS: Woda Cooper discussion topics, example lease, tenant plan

STAFF: Christopher Ward, Director of Development

FOR IN MEETING USE ONLY

MOTION: _____

Roll Call

SUMMARY:

- | | | | | | |
|--------------------------|--------------------------|-----------------------------------|--------------------------|--------------------------|--|
| Y | N | | Y | N | |
| <input type="checkbox"/> | <input type="checkbox"/> | Councilor Rita Joyner, Ward #1 | <input type="checkbox"/> | <input type="checkbox"/> | Councilor Janice Denton, Ward #5 |
| <input type="checkbox"/> | <input type="checkbox"/> | Councilor Michael Harris, Ward #2 | <input type="checkbox"/> | <input type="checkbox"/> | Councilor Brenda Pelham, Ward #6 |
| <input type="checkbox"/> | <input type="checkbox"/> | Mayor John B. Partin, Ward #3 | <input type="checkbox"/> | <input type="checkbox"/> | Councilor Dominic Holloway, Sr., Ward #7 |
| <input type="checkbox"/> | <input type="checkbox"/> | Vice Mayor Jasmine Gore, Ward #4 | | | |

Freedman Pointe

Woda Management and Real Estate, LLC
Managing Agent

Affordable Housing Tax Credit Property

TENANT SELECTION PLAN

Table of Contents

I.	Fair Housing and Equal Opportunity Requirements, Statement of Non-Discrimination	Page 2
II.	Privacy Policy	Page 3
III.	Qualifying for Admission	Page 3-4
IV.	Waiting List Procedure	Page 4-6
V.	Preferences and Resident Selection	Page 6-8
VI.	Verification Requirements	Page 8-10
VII.	VAWA	Page 10-12
VIII.	Applicant Screening	Page 12-14
IX.	Reasonable Accommodations	Page 14-17
X.	Rejection of Ineligible or Unqualified Applicants	Page 17-18
XI.	Acceptance and Move-In of Eligible and Qualified Applicant	Page 18

Throughout this document, the above named Rental Housing will be referred to as the "PROPERTY".

I. FAIR HOUSING AND EQUAL OPPORTUNITY REQUIREMENTS

It is the policy of the Property, to comply fully with Title VI of the Civil Rights Act of 1964, Title VIII and Section 3 of the Civil Rights Act of 1968 (As amended by the Community Development Act of 1974), Executive Order 11063, Section 504 of the Rehabilitation Act of 1973, the Age Discrimination Act of 1975, the Fair Housing Amendments Act of 1988, the Violence Against Women Act (VAWA), and any legislation protecting individual rights of residents, applicants or staff which may subsequently be enacted. These practices apply to policies and procedures when accepting and processing applications, selecting tenants from a waiting list, assigning rental housing, certifying and re-certifying eligibility for assistance.

The Property shall not discriminate because on race, color, national origin, religion, sex gender identity (including gender expression), sexual orientation, disability, age, marital status, height and weight, family/parental status, income derived from public assistance program, political beliefs, or reprisal or retaliation for prior civil rights activity. The Property shall not:

- 1) Deny to any applicant the opportunity to apply for housing, nor deny to any eligible applicant the opportunity to lease housing suitable to their needs.
- 2) Provide housing, which is different than that provided to others;
- 3) Subject a person to segregation to disparate treatment;
- 4) Restrict a person's access to any benefit enjoyed by others in connection with the housing program;
- 5) Treat a person differently in determining eligibility or other requirements for admission;
- 6) Deny a person access to the same level of services.

The Property shall not automatically deny admission to a particular group or category of otherwise eligible applicants. Each applicant in a particular group or category will be treated on an individual basis in the normal processing routine.

The Property will seek to identify and eliminate situations or procedures, which create a barrier to equal housing opportunity for all. In accordance with Section 504, the Property will make a reasonable accommodation for individuals with handicaps or disabilities (applicants or residents). Such accommodations may include changes in the method of administering policies, procedures, or services. In addition, the Property may perform a structural modification to housing and non-housing facilities on site where such modifications would be necessary to afford full access to the housing program for qualified individuals with handicaps.

In reaching a reasonable accommodation with, or performing structural modifications for, otherwise qualified individuals with a disability, the Property is NOT required to:

- 1) Make Structural alterations that require the removal or altering of a load-bearing structural member.
- 2) Provide an elevator in any multifamily housing project solely for the purpose of location of accessible rental housing above or below the grade level;
- 3) Provide support services that are not already part of its housing programs;
- 4) Take any action that would result in a fundamental alternation in the nature of the Program;

- 5) Take any action that would result in an undue financial and administrative burden on the Property.

II. PRIVACY POLICY

It is the policy of the Property to guard the privacy of individuals, to concur with the Federal Privacy Act of 1974, and to ensure the protection of such individual's records maintained by the Property.

Therefore, neither the Property nor its agents shall disclose any personal information obtained in its records to any person or agency unless the individual about whom information is requested has given written consent for such disclosure.

This privacy policy in no way limits the Property's ability to collect such information as it may deem necessary to determine eligibility, compute rent, or determine an applicant's suitability for tenancy.

Consistent with the intent of Section 504 of the Rehabilitation Act of 1973, any information obtained on handicap or disability will be treated in a confidential manner.

Compliance with Requirements Outlined in the Violence Against Women Act

Property managers understand that, regardless of whether state or local laws protect victims of domestic violence, rape, dating violence, sexual assault or stalking, people who have been victims of violence have certain rights under the Violence Against Women Act. If any applicant wishes to exercise the protections provided in the VAWA, he/she should contact the owner/agent immediately. The owner/agent is committed to ensuring that the Privacy Act is enforced in this and all other situations.

The owner/agent will not assume that any act is a result of abuse covered under the Violence Against Women Act. In order to receive the protections outlined in the VAWA, the applicant/resident must specify that he/she wishes to exercise these protections.

III. QUALIFYING FOR ADMISSION

Based on its Restrictive Covenant and Funding Agreements for affordable housing programs (Program), the property may not admit ineligible applicants. Only the following applicants will be admitted:

- 1) Individuals
- 2) Those who qualify as a family, defined as;
 - a. Two or more persons living together, whose income and resources are available to meet the households needs and who are related by blood, marriage, adoption, guardianship or operating of law; or, have evidence of a stable relationship; or
 - b. A single individual with no children who is pregnant at the time of admission or in the process of securing legal custody of any individual under 18 years of age;or

- c. Other persons, including foster children, Live-In Aides, and members temporarily absent, may be considered as part of the family group if they are living or will live regularly with the applicant.
- 3) Those whose annual income at the time of admission does not exceed the HUD-Income limit appropriate for the family size. 60% of the Area Median Gross Income is the highest income limit for which this property is required to rent a specified number of rental housing to tenants who are at or below the guideline. The minimum annual income must be at least 2.5 times the annual rental rate in order to demonstrate ability to pay living expenses. Applicants who have rental subsidy or rental assistance would be exempt from this minimum income requirement. Additional units may be available at a higher income level.
 - 4) All household members must verify a Social Security number, tax identification numbers or an Alien Registration number. If there is a newborn in the house with a pending number, the applicant will be admitted and the file updated when the number is available.
 - 5) Applicants who are full time students must meet at least one of the following criteria:
 - a. The household will not be comprised of all full time students.
 - b. At least one student is receiving assistance under Title IV of the Social Security Act (i.e. TANF)
 - c. At least one student was an orphan or previously under the care and placement responsibility of the state agency responsible for administering foster care or a ward of the court through the age of 18.
 - d. At least one student participates in a program receiving assistance under the Job Training Partnership Act, Workforce Investment Act, or under other similar federal, state or local laws.
 - e. At least one student is a single parent with a child(ren) and this parent is not a dependent of another individual and the child(ren) is/are not dependents of someone other than the other (or absent) parent.
 - f. At least one student is married and entitled to file a joint tax return.

6) Who meet or exceed the Resident Selection Criteria set forth in these policies.

Being eligible however, is not an entitlement to housing. The resident selection criteria is used to demonstrate the applicant's suitability as a resident using verified information on past behavior to document the applicant's ability, either alone or with assistance, to comply with essential lease provisions and any other rules governing tenancy.

The applicant will be judged on past habits and practices related to tenancy and not on any attribute or behavior which may be imputed to a particular group or category or persons of which an applicant may be a member.

IV. WAITING LIST PROCEDURE

When Applications Will Be Accepted

- 1) During office hours. Applications will not be considered accepted until they are presented to the property manager. All applications will be date and time stamped and will be added to the wait list in the order accepted. Applicants will be added to wait lists by bedroom size, preferences and need for a barrier free unit. Applications are available on the Woda website and in boxes outside the rental office for the convenience of our applicants when

the office is closed. Applications will be processed from the waiting list for housing on a first come first serve basis.

Internal Waiting List

- 1) If an existing resident should have a change in circumstances that necessitates a move to a different unit size or a unit with accessible or adaptable features, they will be placed on an internal wait list and given priority for the next available unit. If a grant or program preference does not allow for the internal assignment of a designated unit, that unit will be assigned to applicants who are processed from the preference wait list.
- 2) Existing residents who qualify for a different rent restriction, and the units “float” meaning the restrictions can be moved between units, will be given a restriction swap if the swap is approved by the compliance department through the management agent’s corporate office. Unit swaps cannot be completed by the on-site manager.

Application Fees

No application fee is charged for this community

An application fee of \$35.00 is charged per applicant for this community. The application fee does not exceed the actual cost of the property of the credit report, criminal history report and landlord references.

Opening and Closing Waiting List

- 1) In order to maintain a balanced application pool, the Property may, at its discretion, suspend applicant taking, and close the waiting lists in whole or in part. Property will also update the waiting list and remove the names of those who are no longer interested in or no longer qualify for the affordable housing program(s) offered at this Property.
- 2) If the Property has sufficient applications, it may elect to:
 - a. Close the waiting list completely;
 - b. Close the list during certain times of the year; or
 - c. Restrict intake by preferences or priority. Decisions about closing the waiting list will be based on the number of applicants available for a particular size and type of rental housing, and the ability of the Property to house an applicant in appropriate rental housing within a reasonable period of time. Closing the waiting list, restricting intake, or opening the waiting lists will be posted at the Property office.
- 3) During the period when the waiting list is closed, the Property will **not** maintain a list of individuals who wish to be notified when the waiting list is reopened, advertising will be done in accordance with the Affirmative Fair Housing and Marketing Plan to include newsprint and on-line notifications. Also, the date the wait list will be posted at the rental office.

Determining if the Waiting List may be Closed

- 1) Property will use its Procedure on Waiting List Closure to determine whether the waiting list may be closed

Choosing Rental Housing Size

- 1) When it has been determined that an applicant is to be added to the “Waiting List” the head of household must declare the size of rental housing desired. An applicant may qualify for more than one size rental unit. The Property will not dictate the size of rental housing requested. The Property’s maximum occupancy guidelines are:
 - a. Two (2) persons per bedroom depending upon the size of the housing being applied for and subject to applicable housing, health and safety codes.
 - b. It is assumed (unless otherwise documented) that persons with an established relationship as necessary to qualify as a family, (see Qualifying for Admission, in this document) may share a bedroom. No management standards such as those described below will be used to mandate the assignment of particular size rental housing:
 - 1) Children of opposite sex
 - 2) Children whose age is more than five years apart
 - 3) Adult children, i.e. over the age of eighteen

Change in Preferences Status While on the Waiting List

- 1) Occasionally families on the waiting list who did not qualify for a Preference when they applied will experience a change in circumstances that qualifies them for a Preference. In such cases, it will be the applicant’s duty to contact the Property so that their change in status may be verified to reflect the Preference. Preferences are detailed in Paragraph VI – Preferences and Resident Selection of this document.

Removal of Applicants from the Waiting List:

- 1) In the event there has been no rental housing turnovers the Property staff will update the waiting list every six (6) months. Property will not remove an applicant’s name from the waiting list unless:
 - a. The applicant requests that their name be removed; or
 - b. The applicant was clearly advised of the requirement to tell the Property of his/her continued interest in a rental unit; or
 - c. Property made a reasonable effort to contact the applicant to determine if there is continued interest in housing but has been unsuccessful; or
 - d. Property has notified the applicant of its intention to remove the applicants name because the applicant is no longer qualified.

As applicants approach the top of the waiting list, they will be contacted to update their application. If several applications are being processed in anticipation of upcoming vacancies, the applicant will be informed of their place in line for an upcoming unit or units.

V. PREFERENCES AND RESIDENT SELECTION

It is the Project’s policy that a preference does not guarantee admission. Every applicant must meet the Property’s Resident Selection Standards before being accepted as a resident.

Preferences will be granted to applicants who are otherwise eligible and who, at the time, are certified for admission and satisfy the definition requirements of the preferences described below.

Restrictions for this property are:

10% (7 units) affordable at 40% AMGI
40% (27 units) affordable at 50% AMGI
50% (34 units) affordable at 60% AMGI

*55 years of age and older is housing intended for households in which at least one person in the household is 55 years of age or older.

Grant Preferences for Admission

- 1) Preferences for admission shall be granted to applicants whose circumstances at the time of certification comply with requirements as stated in a Grant, which has been utilized in the development or purchase of the property.

Funding Preferences for Admission

- 1) Preferences for admission shall be granted to applicants whose circumstances at the time of certification comply with requirements as stated in a Restrictive Covenant, which has been utilized in the development or purchase of the property.
- 2) Applicants with Grant or Funding Preferences must be admitted before applicants without Grant or Funding Preferences except when there are no applicants with Grant or Funding Preferences. Verification of Grant or Funding Preferences shall be in accordance with guidelines established elsewhere in this document.

Preferences for Accessible or Adaptable Rental Housing

- 1) For rental housing accessible to or adaptable for persons with mobility, visual or hearing impairments, households containing at least one person with such impairment will have first priority, (as applicable for particular rental housing features). NOTE: Current residents in good standing requiring accessible/adaptable rental housing shall be given priority over applicants requiring the same type of rental housing. Where no such applicants or current residents are at hand, management reserves the right to hold such rental housing available while outreach efforts are in process to obtain applicants with need for such rental housing. Where non-handicapped persons are moved into rental housing designed to meet special needs, they shall do so only after signing a lease addendum agreeing to move to a rental housing with no such design features should an applicant or current residents require an accessible rental housing of the type currently occupied by the non-handicapped person.
- 2) Applicants will be given specific income limit information as well as preference information when they contact the on- site rental office to inquire about available housing. Applicants are encouraged to submit an application and submit to the income verification process in order to be certain that they qualify.
- 3) If a unit becomes available that carries a rent restriction or income restriction that can be swapped with another unit in order to qualify a resident who, under the new restriction would qualify, the corporate level compliance specialist will make the change to accommodate the resident or applicant. Under no circumstances will a site level manager be permitted to change the status of a unit. This unit status swap only applies to units that float under the guidelines of the program.

VI. VERIFICATION REQUIREMENTS

Property shall obtain verification in compliance with requirements set forth in Exhibit 3-2, Acceptable Forms of Verification, of the HUD Handbook 4350.3 and the MSHDA required forms. No decision to accept or reject an applicant shall be made until all verifications, key to the application form have been collected and any necessary follow-up interview has been performed.

Interviews and Verification Process

The following items will be verified to determine eligibility and suitability for admission to the Property based on information supplied by the applicant on a checklist and application:

- 1) Program Specific Eligibility Information
- 2) Annual Income
- 3) Assets and Asset Income
- 4) Program Preferences
- 5) Social Security Numbers, and Birth Certificates of all family members
- 6) Verification of immigration status
- 7) Photo ID for anyone over the age of 18
- 8) Student status
- 9) Credit report supplied by Amrent Report
- 10) Landlord References supplied by Amrent
- 11) Criminal background Check supplied by Amrent through a national database
- 12) National Sex Offender Registry search supplied by Amrent

All the above information must be documented and appropriate verification forms or letters placed in the applicants or residents file.

Income, Assets, family composition and other Program parameters used to determine eligibility will be computed in accordance with the definitions and procedures established in Federal law and set forth in the applicable HUD and state housing finance agency regulations.

Period for Income Eligibility Verification

- 1) Only verified income and asset information that is less than 120 days old may be used for certification. Verified information not subject to change (such as a person's date of birth) need not be re-verified. Information obtained which is subject to change, and for which verifications are more than 120 days old, must be re-verified.
- 2) Management staff will be the final judge of the credibility of any verification submitted by an applicant. If staff considers documentation to be doubtful, it will be reviewed by their Supervisor who will make a ruling about its acceptability. Staff will continue to pursue credible documentation until it is obtained or the applicant is rejected for failing to produce it.

Attempted Fraud

Any information provided by the applicant, that verification proves to be untrue may be used to disqualify the applicant on the basis of attempted fraud. The Property considers false information about the following to be grounds for rejecting an applicant:

- 1) Income, assets, family composition
- 2) Social Security Numbers
- 3) Grant or Funding Preferences
- 4) Previous criminal history
- 5) Previous landlord history
- 6) Previous credit history

“Unwitting errors” that do not secure an advantage with regard to program eligibility, preference, or rent will not be used as a basis to reject applicants.

Verifying Annual Income

- 1) Projections of Annual Income shall be based on the best available information considering 12-month anticipated income, current income rate and effective date, anticipated changes in income; these shall include estimates for each income recipient in the family group.
- 2) The income of irregular workers will be estimated on the basis of the best information available, considering earning ability, work history and annual tax returns where available.
- 3) Overtime income will be computed in accordance with verification obtained from the employer
- 4) When a resident or applicant reports zero income, the manager will note cash expenditures such as, car, telephone, utilities and/or other evidence of cash expenditures. The applicant or resident will be asked to explain the source of income supporting such expenditures on a zero income self-certification form.
- 5) Income is the most important factor in determining an applicant’s eligibility. The Property has established methods of verifying income, which includes:
 - a. Written third-party verification (with an appropriated release) through an employer or public agency.
 - b. Review and copies of documentation provided by the applicant such as:
 - * Social security award letters
 - * Pay stubs
 - * Income tax forms
 - * W-2 forms, or 1099’s
 - * Investment, annuity or retirement account statements
 - c. In the absence of any of the above, notarized self-affidavits from the applicants describing the amount and type of income are acceptable documentation.

VII. VICTIMS OF DOMESTIC VIOLENCE, DATING VIOLENCE, SEXUAL ASSAULT AND STALKING (All Units):

- A. Existing state laws may prohibit a landlord from denying admission to a person simply because she/he has been a victim of domestic violence, dating violence, sexual assault or

stalking. If a person is a victim of domestic violence, dating violence, sexual assault or stalking, it might not be good cause for evicting the victim of that violence. A landlord, however, may be able to evict an individual based on the domestic violence against her/him if it can be proven there is an “actual and imminent threat” to other tenants or staff, if she/he is not evicted. In addition, an individual cannot be denied a housing voucher simply because she/he has been a victim of domestic violence, dating violence, sexual assault or stalking, nor can the landlord evict her/him for this reason, unless the landlord can show that there is an “actual and imminent threat” to the other tenants or staff if she/he is not evicted. [If a property has a layering of federal funding, the laws might protect victims of domestic violence, dating violence, sexual assault or stalking, as well as their immediate family members generally, from being evicted or being denied housing assistance if an incident of violence [that] is reported and confirmed. The law might provide that an incident of actual or threatened domestic violence, dating violence, sexual assault or stalking, does not qualify as a serious or repeated violation of the lease nor does it constitute good cause for terminating the assistance, tenancy, or occupancy rights of the victim. Furthermore, criminal activity directly relating to domestic violence, dating violence, or sexual assault is not grounds for terminating the victim’s tenancy. Owner/Agents (O/A) may bifurcate (divide a lease as a matter of law) in order to evict, remove, or terminate the assistance of the offender while allowing the victim, who is a tenant or lawful occupant, to remain in the unit.]

- B. A tenant may notify the landlord that she/he is a victim and intends to terminate their tenancy. A notice to terminate a tenancy under the law shall be in writing, with one of the following attached to the notice:
1. a copy of a temporary restraining order or a lawfully-issued emergency protective order that protects the tenant or household member from further domestic violence, dating violence, sexual assault or stalking;
 2. a copy of a written report by a peace officer employed by a state or local law enforcement agency acting in his/her official capacity, stating that the tenant or household member has filed a report alleging that she/he or the household member is a victim of domestic violence, dating violence, sexual assault or stalking; and/or
 3. other written documentation from a qualified third-party of the acts constituting domestic violence, dating violence, sexual assault or stalking. The notice to terminate the tenancy shall be given within 60 days of the date that any order described above was made, or with the time period described in a Family/Penal/Code of Civil Procedure Section(s). If the notice to terminate the tenancy is provided to the landlord under this Section, the tenant shall be responsible for payment of rent for 30 days following the giving of the notice, or within the appropriate period as described in the Family/Penal Code of Civil Section(s), and thereafter shall be released from any rent payment obligation under the rental agreement without penalty. Existing law governing the security deposit shall apply.

- C. The landlord might be required to change the locks, as defined, within 24 hours of a written request, as specified, when the restrained person is not a tenant of the same dwelling unit. The restrained person who has been excluded from a dwelling unit might remain liable under the lease with all other tenants of the dwelling unit for rent as provided by the lease. The landlord, under specified circumstances, might also be required to change the locks when the restrained person is a tenant of the same dwelling unit.

If the landlord does not change the locks within 24 hours, the protected tenant might be able to change the locks without the landlord's permission.

- D. **Definitions** – The following definitions are provided as assistance in understanding and implementing the Violence Against Women Act (VAWA) protections. The definitions for domestic violence, dating violence, sexual assault, or stalking and immediate family member have been incorporated into the United States Housing Act.

Domestic Violence includes felony or misdemeanor crimes of violence committed by a current or former spouse of the victim, by a person with whom the victim shares a child in common, by a person who is cohabitating with or has cohabited with the victim as a spouse, by a person similarly situated to a spouse of the victim under the domestic or family violence laws of the jurisdiction receiving grant monies, or by any other person against an adult or youth victim who is protected from that person's acts under the domestic or family violence laws of the jurisdiction.

Dating Violence means violence committed by a person: (A) who is or has been in a social relationship of a romantic or intimate nature with the victim, and (B) where the existence of such a relationship shall be determined based on a consideration of the following factors: (i) the length of the relationship; (ii) the type of relationship; and (iii) the frequency of interaction between the persons involved in the relationship.

Sexual Assault means any proscribed by chapter 109A of Title 18, whether or not the conduct occurs in the special maritime and territorial jurisdiction of the United States or in a Federal prison and includes both assaults committed by offenders who are strangers to the victim and assaults committed by offenders who are known or related by blood or marriage to the victim.

Stalking means (A)(i) to follow, pursue, or repeatedly commit acts with the intent to kill, injure, harass, or intimidate another person; or (ii) to place under surveillance with the intent to kill, injure, harass, or intimidate another person; and (B) in the course of, or as a result of, such following, pursuit, surveillance, or repeatedly committed acts, to place a person in reasonable fear of the death of, or serious bodily injury to, or to cause substantial emotional harm to (i) that person;

(ii) a member of the immediate family of that person; or (iii) the spouse or intimate partner of that person.

Affiliated Individual means, with respect to a person: (a) a spouse, parent, brother, sister, or child of that person, or an individual to whom that person stands in the place of a parent to a child (for example, the affiliated person is a child in the care, custody, or control of that individual); or (B) any individual, tenant, or lawful occupant living in the household of that person.

Bifurcate means to divide a lease as a matter of law so that certain tenants can be evicted or removed while the remaining family members' lease and occupancy rights are allowed to remain intact.

D. Confidentiality of Information Received from Victims of Domestic Violence, Dating Violence, Sexual Assault or Stalking – O/As responding to an incident of actual or threatened domestic violence, dating violence, sexual assault or stalking that could potentially have an impact on a tenant's participation in.

Alternately, in lieu of the certification form or in addition to it, O/As may accept a) a federal, state, tribal, territorial, or local police record or court record or b) documentation signed and attested to by a professional (employee, agent or volunteer of a victim service provider, an attorney, medical personnel, etc.) from whom the victim has sought assistance in addressing domestic violence, dating violence or stalking, or sexual assault or the effects of the abuse. The signatory attests to his/her belief that the incident in question represents bona fide abuse, and the victim of domestic violence, dating violence or stalking, or sexual assault has signed or attested to the documentation.

E. It is possible for someone lawfully occupying the unit, who is also a victim, to be evicted or removed from the home. If the victim commits separate criminal activity, a landlord may evict them for engaging in crime. Furthermore, if a victim poses "an actual and imminent threat to other tenants or those employed at or providing service to the property," they could be evicted, despite domestic law protections. Of paramount consideration is that the landlord may not hold the victim to a more demanding standard than other tenants.

VIII. **APPLICANT SCREENING**

The Applicant Screening Policy:

All applicants for tax credit housing will be screened according to the criteria set forth in this Resident Selection Plan. These criteria, which are based on those set forth in the State Housing Finance Agency Compliance Guidelines, HUD Handbook 4350.3 and Woda Management & Real Estate, LLC Policy and Procedure Manual, the following shall be considered;

- 1) Meeting the maximum and minimum income criteria;
- 2) Household size meets occupancy standards for available unit;
- 3) Past performance in meeting financial obligations;

- 4) A record of disturbance of neighbors, destruction of property, living or housekeeping habits at prior residence, which may adversely affect the health, safety or welfare of other residents, or cause damage to the rental housing or development;
- 5) Involvement in criminal activity on the part of any applicant family member which would reasonably be expected to have a detrimental effect on other tenants, the environment of the apartment community, or where an applicant's history would evidence an inability to comply with lease terms or a likelihood of interfering with management staff;
- 6) Household members who are on the state sex offender registry will be denied housing.
- 7) A record of eviction from housing or termination from residential programs;
- 8) An applicant's ability and willingness to comply with the terms of the Property's lease.
- 9) An applicant's misrepresentation of any information related to eligibility, award of preference for admission, family composition or rent.

Credit Reports

The Property will run a credit report on all applicants through Amrent who pulls from credit reporting agencies. The Amrent report will give records of eviction or judgments against the applicant. If the credit report reveals information upon which the applicant is rejected for housing, an Adverse Action letter is sent identifying the contact information for Amrent in order to appeal or correct reported information. The purpose of this report is to obtain information on the applicant's history of meeting financial obligations and future ability to make timely rent payments and utility payments. Credit reports will be used to screen based on the following criteria:

- 1) Student loans, medical expenses or non-essential utilities do not count.
- 2) Foreclosures are not considered an automatic rejection
- 3) Anyone with bankruptcy on their credit report must show proof of discharge for Chapter 7 and proof of confirmation for Chapter 13.
- 4) Unpaid rent to former landlords and public housing authorities are an automatic denial unless paid in full or a payment arrangement is made that is verified by and satisfactory to the landlord or PHA.
- 5) Utility companies used by the community are shown as delinquent on the credit report will require proof that payment or a payment agreement that is satisfactory to the utility provider has been made and that the applicant is able to have services delivered in their name.
- 6) Applicants participating in programs or receiving assistance that will provide the landlord with the ability to recover any economic losses will be considered to have passed the credit screening.

Landlord References

The Property will run an Amrent report that will contain reported landlord information.

Reviewing the following information:

- 1) A record of eviction from housing or termination from residential programs within the past 5 years will be grounds for rejection. One year of positive rental history, at a minimum, since the eviction will be considered.
- 2) In the case of eviction for non-payment of rent or a late rent payment history, the rent burden on the applicant at the property will be considered.

- 3) If the applicant is participating in a program that provides assistance and/or will cover any economic losses to the landlord, the applicant's unpaid rent or money owed to a landlord will not be considered.

Criminal Background Checks:

The property will run an Amrent report that will pull criminal history from a national database regardless of address history given by the applicant. The report will provide only information on convictions for indictable offenses or exit from incarceration in the past 5 years which evidences a future risk of violent crimes, sexually oriented offenses, gang violence, burglary, robbery, abuse/assault battery, murder/homicide, manslaughter, arson or other indictable offenses. The sale, manufacture or trafficking of drugs will be reported for 5 years and will result in denial of the application. Sexual predators on the state sex offender registry will be denied.

In the event that an applicant has a conviction which would exclude them from renting, or in the event that there is evidence of criminal conduct other than a conviction which would exclude an applicant from renting, an applicant nevertheless has the right to request an individualized assessment of their criminal history. The Property will consider evidence provided by the applicant, including but not limited to the following:

- 1) The circumstances surrounding the crime.
- 2) Was the nature of the criminal offense violent against a person or property or adversely affected the health, safety, and welfare of other people.
- 3) The amount of time has passed since the criminal offense.
- 4) The age of the individual at the time that the crime was committed.
- 5) The time which has elapsed since the crime or crimes which were the reason for the initial denial.
- 6) The amount of time that has lapsed since exit from incarceration.
- 7) The number of total convictions which are part of the applicants criminal history as reported.
- 8) The amount and nature of crimes committed, if any, since the criminal record in question.
- 9) Evidence of good tenant history or references since the commission of the crime.
- 10) Evidence of rehabilitation efforts and/or agency support to maintain stability.

Applicants who request an individualized assessment should be provided an opportunity to provide information to allow ownership to consider any circumstances which would serve to mitigate the criminal convictions within the applicant's criminal history. Applicants will be provided with 72 hours to obtain a verified explanation of their circumstances.

In the event the applicant does not meet the Property's criminal screening criteria after this process, the manager will make a memorandum to the file indicating the factors which were considered to make the denial and notify the applicant in writing that the application is denied.

Obtaining Applicant Releases:

When applicants are interviewed prior to the eligibility and preference determination, all adult applicants will be required to execute an Authorization for Release of Information Form.

Explaining the Screening Process:

Applicants will be told what the Property's applicant selection policy is and what aspects of their background will be checked. This Selection Plan will be made available to all applicants. Some applicants might voluntarily withdraw their applications when they understand the screening process. This is their prerogative.

IX. REASONABLE ACCOMODATIONS

It is illegal to reject an applicant because he or she has a handicap or disability, or for reasons that could be overcome by the Property making a reasonable accommodation of the applicant's disability or handicap. If, even with reasonable accommodation, applicants with disabilities or handicaps cannot meet essential program requirements, it is permissible to reject them. Such insurmountable problems might arise because of behavior or performance in past housing, inability to comply with the terms of the Property's lease, or needed services from the Property staff that represents an alteration in the fundamental nature of the Property's program.

There are three possible stages of processing the application of a person with disabilities under Part 813 and 504 Regulations.

1) Stage 1: Eligibility Review

- a. The first stage of processing is the determination of program eligibility. At this point it is necessary to document that the applicant or one member of the applicant's family applying for housing in a community designated as a Seniors Community is over the age of 55. All applicants must be income qualified.
- b. Student status is recognized to meet the eligibility criteria related to full-time students. If all occupants are found to be full-time students, they may still be eligible to live in a set-aside rental housing if any of the students are:
 - * Receiving assistance under Title IV of the Social Security Act
 - * Enrolled in a job training program receiving assistance under the Job Training Partnership Act or under other similar federal, state or local laws.
 - * Married couple entitled to file a joint federal tax return.
 - * Single parent with minor children, none of whom is a dependent of a third party.

2) Stage 2: Applying the Applicant Selection Criteria

- a. The second stage of processing is applying the applicant selection criteria contained in this Tenant Selection Plan. Neither mitigating circumstances nor reasonable accommodations will be issued for any applicant who does not pass the applicant selection criteria. Thus an applicant who happens to have a disability or handicap but was able to demonstrate a history of meeting financial obligations, caring for a rental housing, avoiding disturbing neighbors and destroying property, refrain from criminal behavior, and, if necessary, ability to comply with the Property's lease, would be recommended for admission with no further reference to or consideration of any disability or handicap.

3) Stage 3: Seeking Mitigating Circumstances or Reasonable Accommodation

- a. The third step in processing would only come into play if an applicant could not meet one or more of the applicant selection criteria. At this point, applicants with

- disabilities or handicaps are entitled to consideration to accommodate their special needs in addition to those afforded to all other applicants.
- b. Staff should hold a second interview with any applicant known to have a disability or handicap who cannot meet one or more of the applicant screening criteria. The purpose of this interview is to determine whether it is possible to admit applicant through consideration of mitigating circumstances or by applying a reasonable accommodation.
 - c. Mitigating circumstances would be facts (that can be verified) that would overcome or outweigh information already gathered in the resident screening process. For example, if an applicant's previous history or disturbing neighbors was very poor; but recent behavior was much improved, the Property could consider this a mitigating circumstance. Property staff must document the improvement if the file contained only data about the former consideration or mitigating circumstances before having their application finally rejected. They shall be advised of the right to such consideration in the Rejection Notice, and given an opportunity to verify any mitigating circumstances pertaining to their rental histories.
 - d. If the evidence of mitigating circumstance presented by the applicant relates to a change in medical condition or course of treatment, the Property shall have the right to refer such information to persons to evaluate the evidence and verify the mitigating circumstance. Where applicants claim that prior, unsuitable behavior that they are not currently engaged in, alcohol abuse or use of illegal drugs, acceptable verification of mitigating circumstances would have to establish that: There is no verified current abuse of alcohol or illegal drugs. For illegal drugs, any use shall constitute abuse. Current abuse shall be defined as verified use more recent than 120 days prior to the date of application.
 - * During the period for which the applicant has claimed no current use, the applicant's behavior in the previously unsuitable area must have shown improvement. Unimproved behavior shall be taken to construe that either the applicant's unsuitable behavior was not caused by alcohol or drug abuse, or the applicant is still engaged in alcohol or drug abuse. In any case, a lack of improvement in a previous unsuitable area will result in a rejected application for applicants in this category. The Property shall also have the right to request further information reasonably needed to verify the mitigating circumstance. If the applicant refused to provide or give access to such further information, the Property will give no further consideration to the mitigating circumstance.
 - e. Screening personnel must keep in mind that an applicant with a handicap or disability who may, for example, be unable to care for a current apartment alone, may still qualify as able to comply with the lease if he or she can demonstrate that assistance with caring for the rental housing has been secured. Such assistance could be in the form of a Live-In Aide, or it could be a friend, family member, chore service or employee of the applicant. It is not the province of the Property to make judgments about the best way to provide assistance, but simply to determine whether the assistance will enable the applicant to meet the screening criteria.

- f. If applicant has a disability and needs a reasonable accommodation in order to participate in the application process or to make effective use of the housing program, they have the right to request such an accommodation. The applicant should define reasonable accommodation and explain the process by which the housing provider will consider requests for reasonable accommodations. If some form of assistance is needed to enable an applicant to comply fully with the lease terms, screening staff should obtain verification that such assistance is available to the applicant. No reasonable accommodation shall be offered prior to receipt of positive verification of assistance.
- g. If no mitigating circumstances exist that satisfy the Property's applicant selection criteria, the Property must consider reasonable accommodation that the Property could make to eliminate barriers to housing the applicant. Reasonable accommodations may take the form of adjustment of policies, practices, and services, where such adjustments offer an acceptable prospect of successful tenancy. For reasonable accommodations necessary and justified by verified circumstances, management may perform structural modifications to housing or non-housing facilities. Such structural modifications may occur in support of mitigating circumstances, reasonable accommodation, or entirely on their own merit. Structural modifications shall be performed only after having determined that the applicant is a qualified individual with handicaps (passes screening and is eligible). An example of a reasonable accommodation might be approving an applicant for a larger rental housing (waiving the rental housing occupancy standards) to permit occupancy by a tenant who otherwise could not live at the Property.
- h. Accommodations, to be considered reasonable, must not cause undue financial and administrative burden or an alteration in the fundamental nature of the Property's affordable housing program. If a service is necessary for compliance with the lease, the Property can not be required to provide it to an applicant with a disability or handicap if it is not provided to other residents, but the Property must consider admitting that applicant if he or she can document that the service will be provided by others at no cost to the Property.
- i. Any applicant with a disability or handicap who cannot meet the applicant screening criteria, taking into account possible mitigating circumstances, reasonable accommodation by the Property, or service needed for lease compliance verified to be provided to the applicant by others, must be rejected.

Assist Animals

An assist animal will not be considered a "pet". If an applicant or resident requests permission for an assist animal to be housed within their rental housing, the management will not use this as justification for rejection of the application or eviction of a tenant. Allowing such an animal will be considered a reasonable accommodation. However, the applicant or resident must provide third party verification of need to document the tenant file. It will be the responsibility of the resident to abide by all rules as set forth in the Pet Policy Agreement. No additional security deposit will be required, however, the resident will be held responsible for any damages caused by said animal.

X. REJECTION OF INELIGIBLE OR UNQUALIFIED APPLICANTS

Applicants who do not pass the eligibility or screening criteria will be sent the Rejection Letter. Such applicants will be notified of their right to schedule an informal meeting within 10 days of the receipt of the letter to discuss the rejection and present additional information. The applicant may also choose to respond in writing. Should an informal meeting be scheduled, it will be conducted by a representative of the owner who is not the property manager who processed the application. The rejection letter will denote the following:

- 1) The household income exceeds current program income limits.
- 2) The household's verifiable income is not two and one half times the monthly income and no rental assistance is available.
- 3) The household size does not meet the occupancy guidelines.
- 4) The credit report indicates a failure to meet past financial obligations. The contact information of the reporting agency is supplied.
- 5) History of failure to pay rent.
- 6) Adverse information reported by previous or current landlord.
- 7) Member or members of the household did not meet criminal screening criteria. An individualized assessment was declined or did not produce additional information upon which the rejection could be reversed.

XI. ACCEPTANCE AND MOVE-IN OF ELIGIBLE AND QUALIFIED APPLICANTS

Determining of Rent and Security Deposit:

Monthly rent amounts will be determined in accordance with the IRS Section 42 Regulations governing the Low-Income Housing Tax Credit housing program and state law.

Offering Rental Housing

When rental housing becomes available for occupancy, it will be offered to the household at the top of the Waiting List for that rental housing type. If the household cannot be contacted within four working days, the offer will be canceled and the rental housing will be offered to the next household on the Waiting List. In that event, the first household will be sent a letter requesting confirmation of its interest in remaining on the Waiting List. If the household replies affirmatively, its application will be retained in its position on the Waiting List; if the reply is negative or if no reply is received within four working days, the applicant will be withdrawn.

Move-In Process

- 1) All adult members of the household will sign the lease and related documents;
- 2) The applicant and management will inspect the rental housing, and will sign the move-in inspection form,
- 3) The applicant will provide verification that all applicable utilities have or will be transferred into the applicant's name, (if applicable)
- 4) The applicant will pay the security deposit (and pet deposit, if applicable):
- 5) The applicant will pay the rent for the first month or partial month of occupancy, as set forth in the lease;
- 6) The applicant will be given a copy of the lease, the move-in inspection form, house rules, and other lease addenda after a complete review of the documents with the manager.

- 7) Keys to the rental housing will be issued to the household.
- 8) A complete orientation of the property amenities and the unit will be given to the applicant to include instruction on operating the appliances and systems in the unit.

Failure to Move-In On Time

Because unit vacancies cause a considerable financial burden on the property, any household that fails to move in on the agreed date will be declined, and the rental housing will be offered to the next household on the Waiting List.

City of Hopewell
City Council Meeting
April 23, 2024
Woda Cooper/Freedman Pointe

Discussion Topics

- 1) Introduction of Woda Cooper and the Freedman Pointe Team
- 2) Explanation of management practices
 - a. TSP
 - b. Lease
- 3) Goals and Objectives for the Community
- 4) Q & A

Lease Agreement

1. **PARTIES TO THIS LEASE:** This Lease Agreement (the "Lease"), is entered into on _____ between the following parties:

"Head of Household": _____ & "Co-Head": _____

"Address": _____, _____, _____, _____

"Unit": _____

"Landlord": _____

"Property Address": _____

All persons signing this Lease are jointly and severally liable for all conditions stated herein.

2. **COMMUNITY DESCRIPTION:** Landlord hereby rents the following property to Resident for the term of this Lease, to be used by Resident only as Residents' private residence:

"Community": _____

"Location": _____, _____, _____, _____

"County": _____

3. **LENGTH (TERM) OF LEASE:** Landlord will rent this Unit to the Resident for the following term: _____, and shall end on _____. Thereafter, Landlord may offer a new Lease if the Resident remains eligible and qualified, or may require Resident to vacate the Unit. If there's a rent increase, Residents will be given a 30-day advance written notice before the expiration of this lease.

If at the expiration of this Lease, no other Lease is signed by the Parties, it will automatically continue as a month-to-month basis and Resident will be notified by Landlord thirty (30) days in advance of the rent increase, to max allowable rent.

Residents are still required to comply with Section 42 Recertification Requirements.

All the agreements made in this Lease, other than the original term, will remain in effect, including the amount of time required for a notice of intent to vacate.

4. **OCCUPANCY:** Resident agrees that the unit will be occupied only by the following individuals:

Name	Age	Relationship	Gender
_____	_____	_____	_____
_____	_____	_____	_____
_____	_____	_____	_____
_____	_____	_____	_____
_____	_____	_____	_____
_____	_____	_____	_____

Any additional individuals' occupying the Unit is prohibited unless written consent has been obtained from the Landlord.

5. **Survivor.** In the event of the death of one Resident in the household, the survivor is entitled to continue the Lease as long as they are eligible or until the expiration of the current Term. In the death of a sole Resident, persons listed as emergency contact or the executor or legal power of attorney will be contacted, personal belongings will be released to said person upon proper proof and identification, and Lease will be terminated within five (5) business days. Any belongings left with the Landlord after this time will be discarded.



"Woda Management & Real Estate, LLC, a division of Woda Cooper Companies, Inc. are an Equal Opportunity Housing provider. We do not discriminate against any applicant on the basis of race, color, national origin, age, disability, religion, sex and familial status, sexual orientation, gender identity (including gender expression), marital status and reprisal."



Lease Agreement

6. **RENT.** Resident shall pay as rental for the premises the sum of \$ _____ in twelve (12) monthly installments of \$ _____ per month (the "Rent"). This Rent is due on or before the first (1st) day of the month, payable by check or money order to the Community. Cash for any reason is prohibited. Unless otherwise specified in writing by the Resident, payments received shall be applied to all outstanding balances first, then to current fines and fees and lastly to Rent. Resident agrees to pay \$ _____ for the first (partial) month ending on _____.
7. **LATE PAYMENTS AND RETURNED CHECKS.** If the Resident does not pay the monthly amount of rent as required by this Lease end of business day on the 5th of the month. Rent is due on or before the first (1st) day of each month. Rent payments not received in full by the end of business day on the fifth (5th) will be charged a one time fee on the sixth (6th) that shall not exceed the lesser of 10 percent of the periodic rent or 10 percent of the remaining balance due and owed. Landlord reserves the right to terminate this Lease for delinquent rent after the fifth (5th) of the month, which is a default herein. Landlord may terminate this Lease for non-payment of rent, as explained in this Lease, even though the Landlord may have, in prior months, chosen to collect the late fee instead of terminating the Lease. In addition, the Landlord may collect an additional fee of \$30.00 if a check is not honored for payment. An NSF must be made up in the form of a cashier's check or money order only. The charges discussed in this paragraph are in addition to the regular monthly Rent payable by the Resident.
8. **UTILITES AND SERVICES.** The following chart lists those utilities for which the Resident and Landlord are responsible for payment. Payment should be made directly to the appropriate utility company.

Gas	<input type="checkbox"/>	Resident	<input type="checkbox"/>	Owner
Electricity	<input checked="" type="checkbox"/>	Resident	<input type="checkbox"/>	Owner
Water	<input checked="" type="checkbox"/>	Resident	<input type="checkbox"/>	Owner
Sewer	<input checked="" type="checkbox"/>	Resident	<input type="checkbox"/>	Owner
Telephone	<input checked="" type="checkbox"/>	Resident	<input type="checkbox"/>	Owner
Trash	<input type="checkbox"/>	Resident	<input checked="" type="checkbox"/>	Owner

If Resident fails to have any utility listed above placed in their name by the lease start date or becomes delinquent, the Landlord may terminate the lease. Any utilities during Residents occupancy that may be billed in the Landlords name, will be billed to the Resident and due in full with next rent payment.

9. **SECURITY DEPOSIT.** A security deposit is required. This is equal to \$ _____ ("Security Deposit"). Landlord will hold this Security Deposit, without interest, for the period that the Resident occupies the Unit. When the Resident has moved from the Unit, the Landlord will determine whether the Resident is eligible for a refund of any or all the Security Deposit. Security Deposits will be refunded according to the following procedures:
- a. Security Deposits will not be used towards the last month's Rent.
 - b. Upon Resident moving from the Unit, Landlord will inspect the Unit and complete a Unit Inspection Report. Landlord will permit Resident to participate in the inspection, if Resident so desires.
 - c. Landlord will refund the Resident the amount of the Security Deposit, less any amount needed to pay the cost of the following items in the following order:
 - i. Damages listed on the Unit Inspection Report which are not due to normal wear and tear, including carpet cleaning;
 - ii. Charges for late payment of Rent and returned checks as described in this Lease;
 - iii. Charges for keys not returned on the move-out date and changing of the locks, as described in this Lease;
 - iv. Rent lost for the months following Resident's moving out due to Resident's failure to give a one (1) calendar month's written notice of intent to move, as required by this Lease;
 - v. Unpaid Rent.
 - d. Landlord may collect reasonable attorney fees and court fees in the event of an eviction suit is filed.

Lease Agreement

Landlord shall forward, by mail, the refund regarding the Security Deposit in the amount computed within the designated time in the Landlord/Tenant Law after this Lease has terminated, if the Resident has given a written forwarding address to the Landlord in sufficient time for the Landlord to comply with this provision. Landlord will give Resident a written list of the charges that were deducted from the Security Deposit. If a forwarding address is not provided in a timely manner, the Security Deposit will be returned via mail to the last known address. If Resident disputes the amount deducted and asks to meet with the Landlord, Landlord shall meet with the Resident to discuss disputed charges. Resident must make the request within ten (10) days of receiving notice of charges; thereafter, Landlord's computation shall be conclusive.

10. **CONDITION OF THE DWELLING UNIT.** By executing this Lease, the Resident acknowledges that the Unit is safe, clean and in good condition. The Resident agrees that all appliances and equipment in the Unit are in good working order. The Resident also agrees that the Landlord has made no promises to decorate, alter, repair or improve the Unit, except as listed on the Move-In Unit Inspection Report.

11. **KEYS AND LOCKS.** Resident agrees not to install additional or different locks or gates on any doors or windows of the Unit without the written permission of Landlord. If Landlord approves Resident's request to install such locks, Resident agrees to provide Landlord with a key for each lock by the next business day. Resident shall return all Unit and mailbox keys to the Landlord when moving out. There will be a \$3.00 charge for each key not returned (or replaced, if a key is lost). If keys are not returned there will be a \$50.00 (per door) lock change charge and a \$20.00 mailbox lock change charge.

12. **REPAIRS.** Repairs to the Unit, appliances and equipment furnished by the Landlord shall be made only by the Landlord. Resident's request for repairs shall be considered as permission to enter the Unit. Resident shall pay for repairs and replacement of all broken windows, mirrors, light fixtures, light bulbs, jammed disposals, replacement of lost keys, re-keying of locks, unblocking plumbing or sewer lines, if caused by misuse. Whenever damage is caused by carelessness, misuse, neglect or intentional act of the Resident, occupants and guest (authorized or implied), Resident agrees to pay:

- a. The cost of all repairs within fifteen (15) days after receipt of Landlord's demand for payment, and
- b. Rent for the period the Unit is damaged, whether or not the Unit is habitable.

Resident is responsible for inspecting smoke detectors in the Unit and reporting any issues immediately. Resident is responsible for furnishing and installing batteries to operate the smoke detector.

13. **RESTRICTIONS OR ALTERATIONS.** Resident agrees not to do any of the following within the Unit without first obtaining Landlord's written permission:

- a. Change or remove any part of the appliance, fixtures or equipment in the Unit;
- b. Paint or install wall paper or contact paper in the Unit;
- c. Attach awning or window guards in the Unit;
- d. Attach or place any fixture, signs or fences on the building, the common areas or the Community grounds;
- e. Install satellite dishes on the Community in anyway without an approved and signed satellite dish addendum;
- f. Attach any shelves, screen doors, or other permanent improvements in the Unit;
- g. Install washing machines, dryers (unless Unit is already equipped for them), fans, freezers, heater or air conditioners; or
- h. Place any aerial, antennas, or other electrical connections on the building.

Should improvements be approved, they will remain upon termination of the Lease as part of the Unit.



Lease Agreement

14. **GENERAL RESTRICTIONS.** Resident must live in the Unit and the Unit must be Resident's sole place of residence. Resident shall use the premises only as a private dwelling for themselves and the individuals named in this Lease. Resident agrees to not permit other individuals to reside in the Unit without obtaining the prior written approval of Landlord. Resident also agrees not to:

- a. Smoke in any of the common areas of the building, including hallways, stairwells, elevators and laundry rooms;
- b. Sublet or assign the Unit or any part of the Unit;
- c. Use the Unit for any unlawful purpose;
- d. Engage in or permit unlawful activities in the Unit, in the common area or on the Community grounds.
- e. Have pets of any kind (except those animals deemed by a physician, as being necessary to achieve normal function of a household member and approved based on reasonable accommodations and modifications; or unless the Community has a pet policy and a pet policy has been signed by the Resident and the pet fee has been paid);
- f. Make or permit noises or acts that will disturb the right or comforts of neighbors as defined by local ordinances or authorities. Resident agrees to keep the volume of any radio, phonograph, stereo, television or musical instrument at a level which will not disturb neighbors.
- g. Residents are responsible for all occupants and guests (approved or implied). Landlord may exclude from the Community any visitor, who in its judgement, have been violating the law, Lease or Community Rules or is disturbing or threatening the rights of other residents, guests or Landlord and its agents.

15. **ANNUAL CERTIFICATION OF INCOME AND HOUSEHOLD SIZE.** For the Community to properly comply with the Program, the income of each applicant applying for residency must be certified initially and annually. Therefore, on an annual basis, prior to the anniversary of the Lease execution, the Landlord will request that Resident report the number of persons in Residents unit, the total household income and the source of all income and to supply any other information as required to be obtained by the Landlord per Program rules and regulations. Resident agrees to provide accurate statements of this information and to do so by the date specified in the Landlord's request. This report shall be in writing and signed by Resident and shall be accompanied by such supporting documents as Landlord may request. Failure to timely report or the submission of a false report, shall be grounds for immediate eviction.

16. **STUDENTS.** Resident acknowledges that the Landlord is operating the Community pursuant to the rule and regulations of Section 42 of the Internal Revenue Code, the Federal Low-Income Housing Tax Credit program (the "Program"). The Program provides for specific qualification restrictions with respect to the occupancy of Program units by full-time students. Resident acknowledges that qualification to remain as a Resident is always dependent upon the household meeting all student status requirements. Should Resident fail to meet all student status requirements, Resident(s) will be deemed an unqualified Resident(s) and will be subject to immediate eviction. Resident(s) agrees to notify Landlord immediately of any changes in student status by any member of the household.

17. **COMMUNITY RULES.** Resident agrees to obey the Rules and Regulations, which are attached to this Lease. Resident agrees to obey additional rules which may be established by the Landlord from time to time after the effective date of this Lease. Resident will receive written notice of any new rule at least thirty (30) days in advance of the rule being enforced.

18. **ACCESS BY LANDLORD.** The Landlord agrees to enter the Unit only during reasonable hours, to provide reasonable, advance, notice, when allowable, of its intent to enter the Unit, except in emergency situations or as outlined below:

- a. The Resident agrees to permit the Landlord, agents or other persons, when authorized by the Landlord, to enter the Unit for purposes of making reasonable repairs and periodic inspections, including State and Federal Program required inspections.



Lease Agreement

- b. Landlord may enter the Unit for inspections monthly. An advanced notice of twenty-four (24) hours will be delivered, when allowable.
- c. When Resident has given notice of intent to move, Resident agrees to permit Landlord to show the Unit to prospective Residents during reasonable hours.
- d. If Resident moves before this Lease ends, Landlord may enter the unit to decorate, remodel, alter or otherwise prepare the Unit for re-occupancy.

19. **TERMINATION OF RESIDENCY:** To terminate this Lease, Resident must give a one (1) month calendar written notice. Resident is liable for Rent to the end of the Lease Term or notice, whichever is furthest out.

- a. With proper one (1) month calendar written notice, the Resident will be responsible for any balances on their account at the time of move-out, including damages and late charges, and a broken lease fee
 - During the first twelve (12) months of this Lease Term, if the Lease is terminated, the Resident will be charged a termination fee equal to two (2) month's Rent.
 - After the twelve (12) months of this Lease Term, if the Lease is terminated, the Resident will be charged a termination fee equal to one (1) months' rent.

b. If the Resident terminates the Lease after the Lease Term, without a one (1) month calendar proper written notice, the Resident will be held responsible for any balance on their account at the time of move out such as damages, rent, late charges and broken lease fee equal to one (1) months' rent.

c. If the Resident abandons the Unit, all max allowable fees will be billed to Resident's account. Abandonment is described as the absence for fourteen (14) consecutive days, while all or any portion of rent is unpaid. If the Unit is determined to be abandoned Resident's belongings will be inventoried, stored or disposed of and the apartment re-rented without liability to Landlord.

d. If the Resident is given a rental concession at the time of move in, the Resident must fulfill the initial lease term or the rental concession will be forfeited and the Resident back charged the full amount of the rental concession upon move out. The Landlord may terminate this Lease if the Resident violates any of the terms or conditions contained in this Lease, the Rules and Regulation or any attachments to this Lease, including the Resident providing false or misleading information on the income certification attached.

All termination notices must:

- a. Be in writing, at least one (1) calendar month prior to the date the Resident will be required to move from the unit. Example: Resident gives notice on May 15th, the notice will be up on June 30th;
- b. Specify the date this Lease will terminate;
- c. State the grounds for termination;
- d. Notwithstanding anything stated above, the Landlord may immediately terminate the Lease in the case of monetary default (non-payment of rents, fees and any other charges as specified in this Lease), and violation of the Rules and Regulations.

Landlord may terminate this Lease for violation outlined in other areas of this Lease including the following reasons: residents material noncompliance with terms of this Lease; residents material failure to carry out obligations under any State or Federally Funded Assistance Agreement; drug related or criminal activity engaged in, on or near the premises, by resident, occupant or guest (authorized or implied); drug related or criminal activity that interferes with the health, safety or right to peaceful enjoyment of the premises by other residents, Landlord or Landlord's Agent, including all management staff; OR said activity threatens those rights; resident is fleeing to avoid prosecution, custody or confinement after conviction for a crime, attempt to commit a crime that is a felony under the laws of the place from which the individual flees.

Landlord may terminate or refuse to renew this Lease for "other good cause". Other good cause may be defined as: one or more substantial violation(s) of this Lease; repeated minor violation of this Lease; disrupt the livability of the project; interference with the management of the Community; have an adverse financial effect on the Community.

Lease Agreement

19. **HAZARDS AND INSURANCE.** Resident shall not undertake or permit occupants and guest (authorized or implied) to undertake, any hazardous acts or do anything that will increase the Community's insurance premiums. If the Unit is damaged by fire, wind or rain to the extent that the Unit cannot be lived in and the damage is not caused by Resident, Resident will be responsible for Rent only to the date of destruction. Resident's obligation to pay Rent will begin again when the Unit has been repaired to a livable condition or Resident has been moved to a livable replacement Unit. The insurance referred to in this paragraph does not cover Resident's belongings. Residents are advised to obtain renter's insurance.

20. **LANDLORD'S AGENT.** The Landlord's Agent is authorized to act on behalf of the Landlord in all matters pertaining to this Lease. Residents shall direct all correspondences to the Landlord's Agent at the following address:

Landlord's Agent: Woda Cooper Companies

Agent Address: 500 South Front Street, 10th Floor
Columbus, OH 43215

Phone: (614) 396 – 3200

Landlord may from time to time change the Landlord's Agent. This will not affect the conditions enforceability or viability of this Lease.

21. **CONTENTS OF THIS LEASE AGREEMENT.** This Lease and the Attachments thereto contain the entire agreement between Resident and Landlord regarding the Unit. If any Court declares any part of this provision of this Lease to be invalid or illegal, all the terms of this Lease will remain in effect and both the Landlord and Resident will continue to be bound by them. RESIDENT SHOULD NOT RELY ON ANY VERBAL PROMISES MADE BY LANDLORD OR LANDLORD'S AGENT WHICH ARE NOT MADE A PART OF THIS WRITTEN LEASE AGREEMENT.

22. **ATTACHMENT (ADDENDUMS) TO THIS LEASE AGREEMENT:**

- | | |
|--|--|
| <ol style="list-style-type: none"> 1. Section 42 Lease Addendum * 2. Attorney Fees Agreement 3. Automated Clearing House Agreement 4. Inventory Condition Form 5. Notice of Intent to Move Out 6. Pet Agreement 7. Resident Personal File Update 8. Rules and Regulations - Acknowledgment of General Rules 9. Rules and Regulations - Bed Bug Agreement 10. Rules and Regulations - Drug Free Housing 11. Rules and Regulations - Emergency Pull Cord * 12. Rules and Regulations - Garage, Carport and Storage * 13. Rules and Regulations - Health and Safety 14. Rules and Regulations - Key and Access Device Agreement * 15. Rules and Regulations - Lead Based Paint Disclosure * 16. Rules and Regulations - Maintenance Emergencies 17. Rules and Regulations - Maintenance Emergencies Unit Flyer 18. Rules and Regulations - Mold Information 19. Rules and Regulations - Package Acknowledgment 20. Rules and Regulations - Rental Concession 21. Rules and Regulations - Renters Insurance 22. Rules and Regulations - Satellite Dish Agreement | <ol style="list-style-type: none"> 23. Rules and Regulations - Schedule of Charges 24. Rules and Regulations - Smoke Detector 25. Rules and Regulations - Smoke Free Agreement 26. Rules and Regulations - Vehicle Responsibility 27. Rules and Regulations - Rooftop Terrace Agreement * 28. Rules and Regulations - Washer and Dryer Agreement * 29. Security Deposit Agreement 30. U.S. Service Members Civil Relief Act * 31. Utility Agreement 32. Utility Record - Permission to Obtain 33. Utility Transfer Confirmation 34. VAWA Lease Agreement and Receipt of Forms * 35. Healthy Home Guide 36. Lead Based Paint - Know your rights ** 37. Barrier Free Agreement * 38. Support and Service Animal Agreement * 39. Emergency Pull Cord Agreement * 40. Other: _____ |
|--|--|
- * = If Applicable ** = Communities built prior to 1978

IN WITNESS, WHEREOF, Landlord and Resident have executed this Lease the day and year first above mentioned.

_____	_____	_____
Head of Household Signature	Head of Household Printed Name	Date
_____	_____	_____
Co-Head Signature	Co-Head Printed Name	Date
_____	_____	_____
Resident Signature	Resident Printed Name	Date
_____	_____	_____
Agent for Owner Signature	Agent for Owner Printed Name	Date

Title 18, Section 1001 of the U.S. Code states that a person is guilty of a felony for knowingly and willingly making false or fraudulent statements to any department of the United States Government. HUD and any owner (or any employee of HUD or the owner) may be subject to penalties for unauthorized disclosures or improper uses of information collected based on the consent form. Use of the information collected based on this verification form is restricted to the purposes cited above. Any person who knowingly or willingly requests, obtains, or discloses any information under false pretenses concerning an applicant or participant may be subject to a misdemeanor and fined not more than \$5,000. Any applicant or participant affected by negligent disclosure of information may bring civil action for damages and seek other relief, as may be appropriate, against the officer or employee of HUD or the owner responsible for the unauthorized disclosure or improper use. Penalty provisions for misusing the social security number are contained in the Social Security Act at 208(a) (6), (7) and (8). Violations of these provisions are cited as violations of 42 U.S.C. 408 (a) (6), (7) and (8).

COMMUNICATIONS
FROM CITIZENS

PUBLIC HEARING

REGULAR BUSINESS

R-1



CITY OF HOPEWELL CITY COUNCIL ACTION FORM

Strategic Operating Plan Vision Theme:

- Civic Engagement
- Culture & Recreation
- Economic Development
- Education
- Housing
- Safe & Healthy Environment
- None (Does not apply)

Order of Business:

- Consent Agenda
- Public Hearing
- Presentation-Boards/Commissions
- Unfinished Business
- Citizen/Councilor Request
- Regular Business
- Reports of Council Committees

Action:

- Approve and File
- Take Appropriate Action
- Receive & File (no motion required)
- Approve Ordinance 1st Reading
- Approve Ordinance 2nd Reading
- Set a Public Hearing
- Approve on Emergency Measure

COUNCIL AGENDA ITEM TITLE: Conditional Use Permit Request to Construct a Single-Family Dwelling on Non-Conforming Lot, Parcel #033-0020 on Boston St.

ISSUE: City ordinance requires CUP approval to construct a single-family dwelling on non-conforming lots. All setbacks must be met.

RECOMMENDATION: City Administration recommends no action at this time.

TIMING: City Council is requested on May 14, 2024

BACKGROUND: See enclosed documents

ENCLOSED DOCUMENTS: CUP application, staff report, presentation

STAFF: Christopher Ward, Director of Development

FOR IN MEETING USE ONLY

MOTION: _____

Roll Call**SUMMARY:**

- | Y | N | | Y | N | |
|--------------------------|--------------------------|-----------------------------------|--------------------------|--------------------------|--|
| <input type="checkbox"/> | <input type="checkbox"/> | Councilor Rita Joyner, Ward #1 | <input type="checkbox"/> | <input type="checkbox"/> | Councilor Janice Denton, Ward #5 |
| <input type="checkbox"/> | <input type="checkbox"/> | Councilor Michael Harris, Ward #2 | <input type="checkbox"/> | <input type="checkbox"/> | Councilor Brenda Pelham, Ward #6 |
| <input type="checkbox"/> | <input type="checkbox"/> | Mayor John B. Partin, Ward #3 | <input type="checkbox"/> | <input type="checkbox"/> | Councilor Dominic Holloway, Sr., Ward #7 |
| <input type="checkbox"/> | <input type="checkbox"/> | Vice Mayor Jasmine Gore, Ward #4 | | | |



The City
of
Hopewell, Virginia

300 N. Main Street - Department of Development - (804) 541-2220 - Fax: (804) 541-2318

CONDITIONAL USE PERMIT APPLICATION

APPLICATION FEE: \$300

APPLICATION # 20240417

APPLICANT: MewCo, LLC
ADDRESS: 4606 Chippoke Rd.
Chester, VA 23831
PHONE #: (804)519-0937 or (804)519-4531 FAX #: (804)739-7212
EMAIL ADDRESS: mewco1lc@gmail.com

INTEREST IN PROPERTY: X OWNER OR AGENT
IF CONTRACT PURCHASER, PROVIDE A COPY OF THE CONTRACT OR A LETTER OF THE PROPERTY OWNER'S CONSENT TO MAKE APPLICATION.

OWNER: MewCo, LLC
ADDRESS: 4606 Chippoke Rd.
Chester, VA 23831
PHONE #: (804)519-0937 or (804)519-4531 FAX #: (804)739-7212

PROPERTY ADDRESS / LOCATION:
Boston St., Hopewell, VA 23860

PARCEL #: 033-0020 ACREAGE: .208 ZONING: R2

*** IF REQUIRED BY ARTICLE 16 OF THE ZONING ORDINANCE, A SITE PLAN MUST ACCOMPANY THIS APPLICATION ***

ATTACH A SCALED DRAWING OR PLAT OF THE PROPERTY SHOWING:

- 1. FLOOR PLANS OF THE PROPOSED BUILDINGS. _____
- 2. THE PROPOSED DEVELOPMENT WITH FRONT, SIDE, AND REAR ELEVATIONS. _____

w.g.

City of Hopewell, VA
Permits / Inspect. - 20240417/CUP - 2024
024787-0002 debra mc... 03/15/2024 11:42AM
-
0 -
CONDITIONAL USE PERMIT - REVIEW
Payment Amount: \$300.00
Transaction Amount: \$300.00
CHECK: 1007

THIS REQUEST FOR A CONDITIONAL USE PERMIT IS FILED UNDER SECTION
OF THE ZONING ORDINANCE.

PRESENT USE OF PROPERTY:
Currently, this is a vacant lot.

THE CONDITIONAL USE PERMIT WILL ALLOW:
The conditional use permit will allow us to build a quality affordable starter home that will add to the stock of Hopewell for the family and the county's benefit for decades to come.

PLEASE DEMONSTRATE THAT THE PROPOSAL AS SUBMITTED OR MODIFIED WILL NOT AFFECT ADVERSELY THE HEALTH, SAFETY, OR WELFARE OF PERSONS RESIDING OR WORKING IN THE NEIGHBORHOOD OF THE PROPOSED USE.
This proposal will not affect the safety of persons already residing in the neighborhood as we will strive to only hire the most competent Class A contractor to ensure that the vendors hired will adhere to all safety precautions and safe work practices.

PLEASE DEMONSTRATE THAT THE PROPOSAL WILL NOT BE DETRIMENTAL TO PUBLIC WELFARE OR INJURIOUS TO THE PROPERTY OR IMPROVEMENTS IN THE NEIGHBORHOOD.
We would conduct several thorough analysis and surveys. One being a topographical survey that would show proper elevation for the foundation of the home to sit and show proper storm water runoff. Also, we would review and implement health and safety plans to assess any potential risk to the public health.

PLEASE DEMONSTRATE HOW THE PROPOSAL AS SUBMITTED OR MODIFIED WILL CONFORM TO THE COMPREHENSIVE PLAN AND THE PURPOSES AND THE EXPRESSED INTENT OF THE ZONING ORDINANCE.
According to the comprehensive plan, Hopewell resident population is projected to grow from 22,500 to 23,625 through the year 2025. We believe with that projection, building a single-family home on the available vacated lots, coincides with the comprehensive plan, by adding to the stock of Hopewell. Placing a high-quality modern starter single-family home enhances the neighborhood's appeal and pride which would continue to serve well for future generations to come.

AS OWNER OF THIS PROPERTY OR THE AUTHORIZED AGENT THEREFOR, I HEREBY CERTIFY THAT THIS APPLICATION AND ALL ACCOMPANYING DOCUMENTS ARE COMPLETE AND ACCURATE TO THE BEST OF MY KNOWLEDGE.

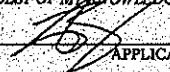

APPLICANT SIGNATURE

14 MAR 2024

DATE

Archie R. Mow, Jr.

APPLICANT-PRINTED NAME

OFFICE USE ONLY

DATE RECEIVED _____ DATE OF ACTION _____

APPROVED _____ DENIED

APPROVED WITH THE FOLLOWING CONDITIONS:

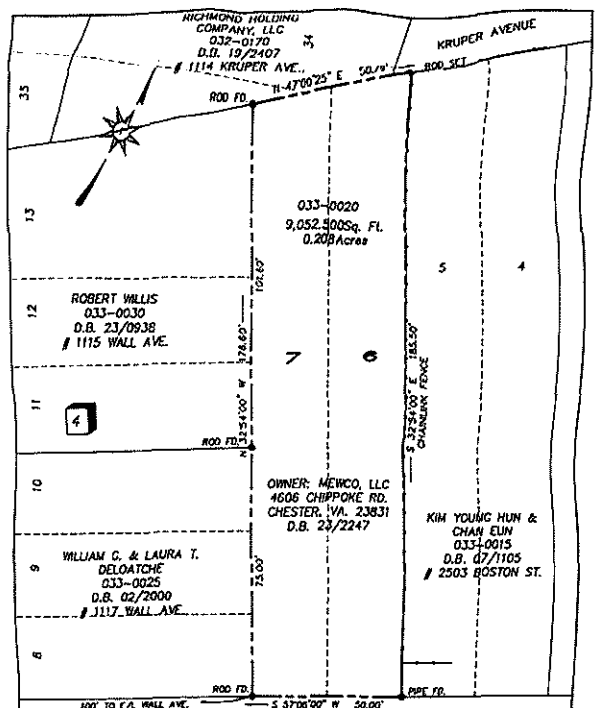

BOSTON STREET
50' R/W

PLAT SHOWING
LOTS 6 & 7 ~ BLOCK 4 ~ SECTION 2
DUPONT ANNEX
HOPEWELL VIRGINIA
SURVEYED FOR
MEWCO, LLC

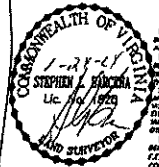

THIS SURVEY WAS PREPARED WITHOUT THE BENEFIT OF A TITLE SEARCH AND IS SUBJECT TO ANY ENCUMBRANCES THAT MAY AFFECT THEREIN. THIS IS TO CERTIFY THAT ON 1/24/24 TO THE BEST OF MY PROFESSIONAL KNOWLEDGE AND BELIEF I HAVE AN ACCURATE TRUE SURVEY OF THE PREMISES SHOWN HEREON. I HAVE ALL APPROPRIATE RECORDS ON FILE, AND I HAVE REASON TO BELIEVE THAT THE SAME ARE CORRECT. I HAVE BEEN ADVISED BY THE ADJUDICATOR THAT THE PROPERTY IS IN ZONE "X" OF THE 100-YEAR FLOOD HAZARD AREA AS SHOWN ON FEMA FLOOD INSURANCE RATE MAPS. COMMUNITY PANEL # 5000000000, DATED 11/6/2022.

BASELINE LAND SURVEYING
326 CRANE AVENUE
PETERSBURG, VIRGINIA 23003
TEL: 804.722.9810
FAX: 804.722.9817

DATE: JANUARY 24, 2024 SCALE: 1" = 25'
DRAWN BY: SLB
CHECKED BY: CALC. CHK: SLB

REV: JOB NO.: 23906 F.B. 211/74

NOT USED. SEE THE NOTES ON THE PREVIOUS JOB NO.





1) ATTIC VENTILATION AS PER R806; 1240 SQ. FT/300=221 SQ. IN. MASTER FLOW
 ALUMINUM RIDGE VENT: 11 LIN. FT. MASTER FLOW EAP 4X12 SOFFIT VENTS : 11 EA.



Front Elevation

Scale: 1/4" = 1'-0"

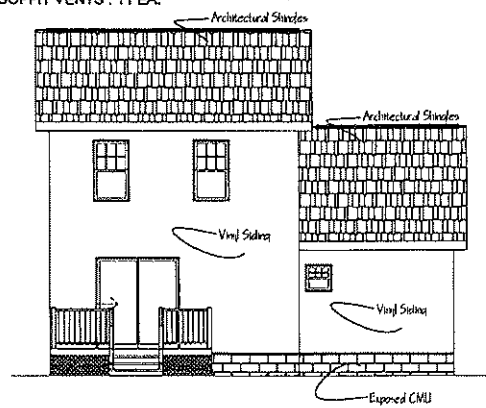

Rear Elevation

Scale: 1/4" = 1'-0"

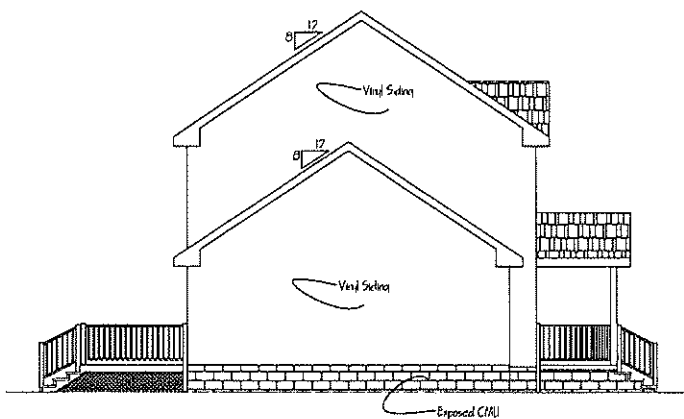

Left Side Elevation

Scale: 1/4" = 1'-0"

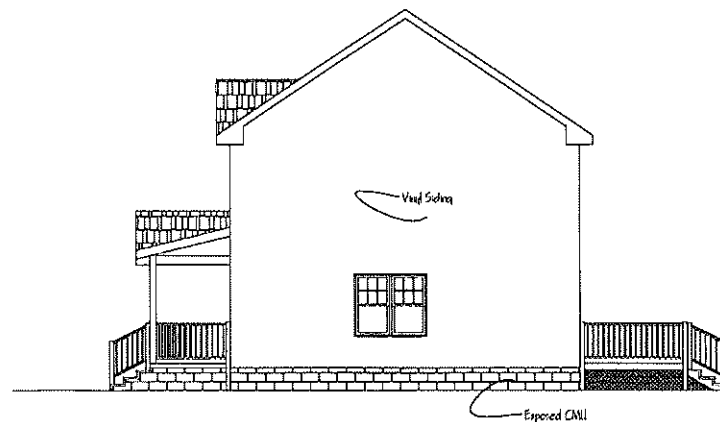

Right Side Elevation

Scale: 1/4" = 1'-0"

REVISIONS

1	
2	
3	

NEW CONSTRUCTION
 ELEVATIONS
 LOTS 6 & 7 BOSTON STREET
 HOPEWELL, VA

DATE	3/4/2024
SCALE	1/4"=1'-0"
GOLDEN MEYES, LLC	
ALISHA STEVENSON	
2/6	

THE DESIGN AND PLANS SHOWN
 ARE THE PROPERTY OF GOLDEN MEYES, LLC
 AND ARE NOT TO BE REPRODUCED OR
 COPIED IN ANY MANNER WITHOUT THE
 WRITTEN PERMISSION OF THE OFFICE.

8" x 16" FOUNDATION VENT CALCULATIONS
 12/20/2024 by L. STEVENSON

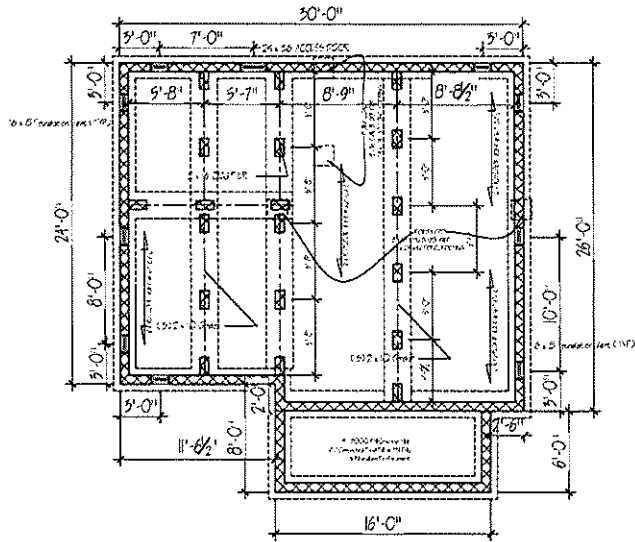

Foundation Plan

Scale: 1/4" = 1'-0"

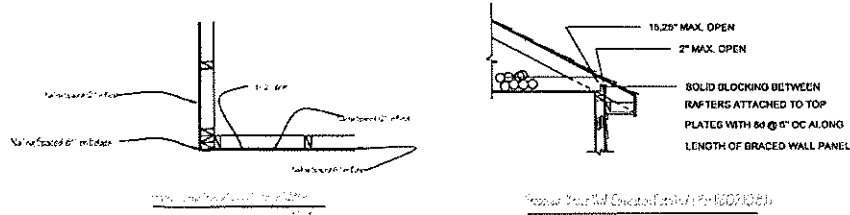

Classic Wall Bracing Worksheet
 per 2021 Virginia Residential Code Section R602.10

Ultimate Wind Speed (mph)	120		130		140		150		160		170		180		190		
DWV Designation	1	2	A	B	1	2	A	B	1	2	A	B	1	2	A	B	
No. of Floors Above DWV	1	0	1	0	1	0	1	0	1	0	1	0	1	0	1	0	
DWV Method	CS-WSP	CS-WSP	CS-WSP	CS-WSP	CS-WSP	CS-WSP	CS-WSP	CS-WSP	CS-WSP	CS-WSP	CS-WSP	CS-WSP	CS-WSP	CS-WSP	CS-WSP	CS-WSP	
Average DWV Spacing (ft)	22	22	18	18	16	16	14	14	12	12	10	10	8	8	6	6	
Tabular Requirement (ft)	7.50	7.50	3.20	3.20	6.30	6.30	2.90	2.90	2.00	2.00	3.20	3.20	1.50	1.50	1.50	1.50	
Exposure	B	1.00	B	1.00	B	1.00	B	1.00	B	1.00	B	1.00	B	1.00	B	1.00	
Low-to-High H _z (ft)	7.00	0.91	7.00	0.91	7.00	0.92	7.00	0.91	7.00	0.92	7.00	0.92	7.00	0.92	7.00	0.92	
Max. Wall H _z (ft)	8.00	0.90	8.00	0.90	8.00	0.90	8.00	0.90	8.00	0.90	8.00	0.90	8.00	0.90	8.00	0.90	
No. of DWV's	2	1.00	2	1.00	2	1.00	2	1.00	2	1.00	2	1.00	2	1.00	2	1.00	
Dist. Between Panels (ft)	No	1.00	No	1.00	No	1.00	No	1.00	No	1.00	No	1.00	No	1.00	No	1.00	
Added Hold-downs?	No	1.00	No	1.00	No	1.00	No	1.00	No	1.00	No	1.00	No	1.00	No	1.00	
Joints Braced?	No	2.00	No	2.00	No	2.00	No	2.00	No	2.00	No	2.00	No	2.00	No	2.00	
Fasteners @ 4" o.c.?	No	1.00	No	1.00	No	1.00	No	1.00	No	1.00	No	1.00	No	1.00	No	1.00	
Required SWP Length (ft)	17.29	17.29	4.72	4.72	10.27	10.27	2.90	2.90	2.00	2.00	4.72	4.72	1.50	1.50	1.50	1.50	
Contributing Length (ft)	1	Method	Length	Method	Length	Method	Length	Method	Length	Method	Length	Method	Length	Method	Length	Method	Length
	2	CS-WSP	4.00	CS-WSP	4.00	CS-WSP	4.00	CS-WSP	4.00	CS-WSP	4.00	CS-WSP	4.00	CS-WSP	4.00	CS-WSP	4.00
	3	CS-WSP	3.00	CS-WSP	3.00	CS-WSP	4.00	CS-WSP	4.00	CS-WSP	4.00	CS-WSP	4.00	CS-WSP	4.00	CS-WSP	4.00
	4	CS-WSP	3.00	CS-WSP	3.00	CS-WSP	4.00	CS-WSP	4.00	CS-WSP	4.00	CS-WSP	4.00	CS-WSP	4.00	CS-WSP	4.00
	5																
	6																
	7																
Actual SWP Length (ft)	14.20	13.00	12.00	12.00	7.00	7.00	8.00	8.00	17.00	17.00	17.00	17.00	17.00	17.00	17.00	17.00	
Actual R Required?	PASS	PASS	PASS	PASS	PASS	PASS	PASS	PASS	PASS	PASS	PASS	PASS	PASS	PASS	PASS	PASS	
DWV's 4:20 Apart?	Yes	Yes	Yes	Yes	Yes	Yes	Yes	Yes	Yes	Yes	Yes	Yes	Yes	Yes	Yes	Yes	
≥ 2 Panels in DWV?	Yes	Yes	Yes	Yes	Yes	Yes	Yes	Yes	Yes	Yes	Yes	Yes	Yes	Yes	Yes	Yes	
DWV 16" from End?	Yes	Yes	Yes	Yes	Yes	Yes	Yes	Yes	Yes	Yes	Yes	Yes	Yes	Yes	Yes	Yes	
Continuous Sheathing	End 1	End 2	End 1	End 2	End 1	End 2	End 1	End 2	End 1	End 2	End 1	End 2	End 1	End 2	End 1	End 2	
End Conditions	3	3	3	3	3	3	3	3	3	3	3	3	3	3	3	3	
DWV Compliance	PASS	PASS	PASS	PASS	PASS	PASS	PASS	PASS	PASS	PASS	PASS	PASS	PASS	PASS	PASS	PASS	

REVISIONS

1	
2	
3	

THE DESIGN AND PLANS SHOWN ON THIS DRAWING ARE THE PROPERTY OF GOLDEN KEYS, LLC. THESE PLANS SHALL BE USED BY ANY INDIVIDUAL OR ENTITY WITHOUT THE WRITTEN PERMISSION OF THIS OFFICE.

NEW CONSTRUCTION
FOUNDATION PLAN
LOTS 6 & 7 BOSTON STREET
HOPEWELL, VA

DATE: 3/4/2024
 SCALE: 1/4" = 1'-0"
 GOLDEN KEYS, LLC
 ALISHA STEVENSON

3/6

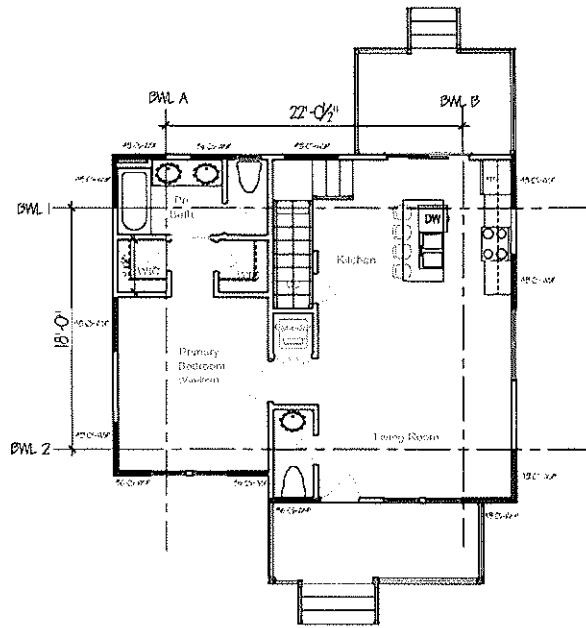

First Floor Brace Wall Plan

Scale: 1/4" = 1'-0"

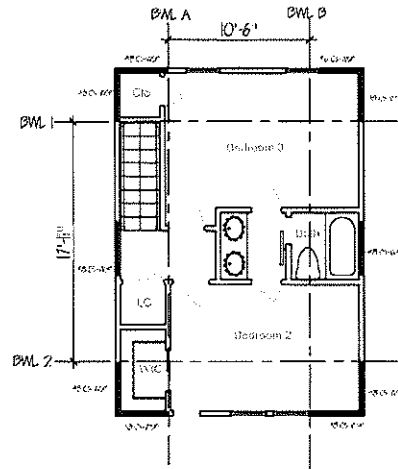

Second Floor Brace Wall Plan

Scale: 1/4" = 1'-0"

REVISIONS

2
5

I-5 DESIGN AND PLANS B-274N
 PERMIT FOR EXISTING GARAGE
 PROJECT OF GOLDEN KEYES, LLC
 4500 WOODBURN AVENUE
 HOPEWELL, VA 22961
 PERMITTED BY THE OFFICE

NEW CONSTRUCTION
 FLOOR PLAN
 LOTS 6 & 7 BOSTON STREET
 HOPEWELL, VA

DATE	3/6/2024
SCALE	1/4" = 1'-0"
GOLDEN KEYES, LLC	
ALISHA STEVENSON	
	4/6

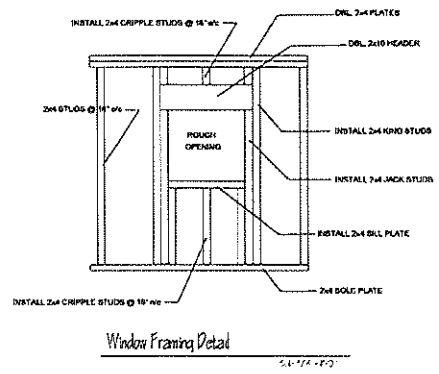
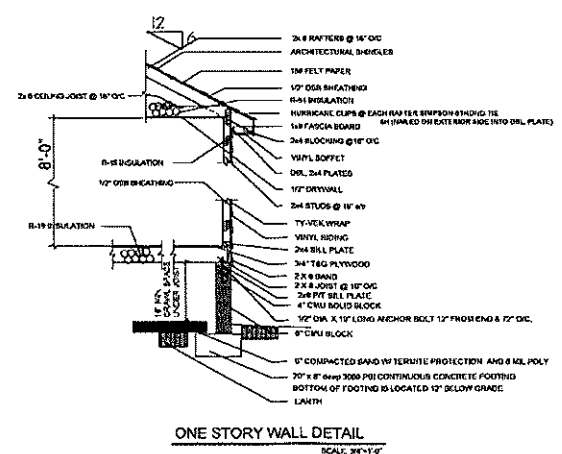
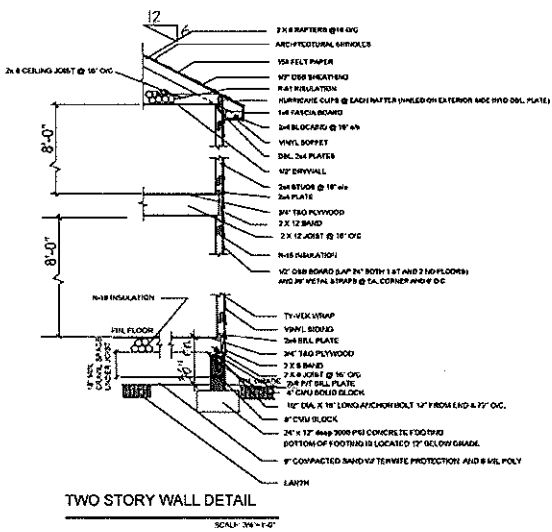
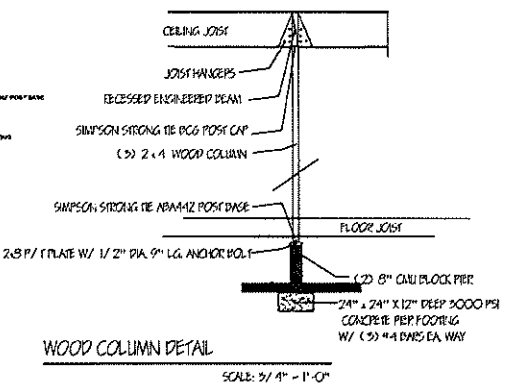
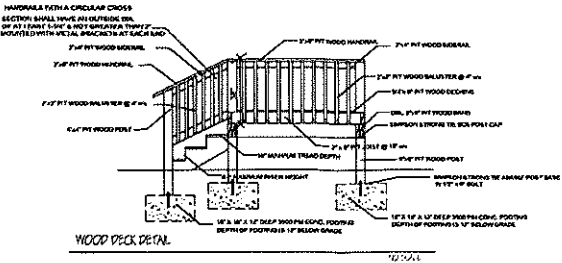
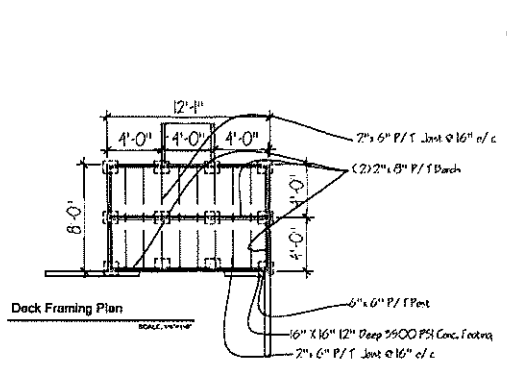

REVISIONS	
2	
3	

THE DIMENSIONS AND FINISHES FOR THIS PROJECT ARE BASED ON THE 2018 INTERNATIONAL RESIDENTIAL CODE BOOK. ANY CHANGES TO THESE DIMENSIONS AND FINISHES SHALL BE INDICATED BY A REVISION TO THIS SET OF DRAWINGS. THE CONTRACTOR SHALL BE RESPONSIBLE FOR VERIFYING ALL DIMENSIONS AND FINISHES WITH THE ARCHITECT PRIOR TO CONSTRUCTION.

NEW CONSTRUCTION	FLOOR PLAN
	LOTS 6 & 7 BOSTON STREET
	HOPEWELL, VA

DATE	3/4/2024
SCALE	1/4" = 1'-0"
GOLDEN KEYES, LLC	
ALISHA STEVENSON	
	5/6

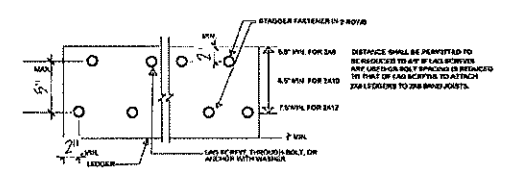
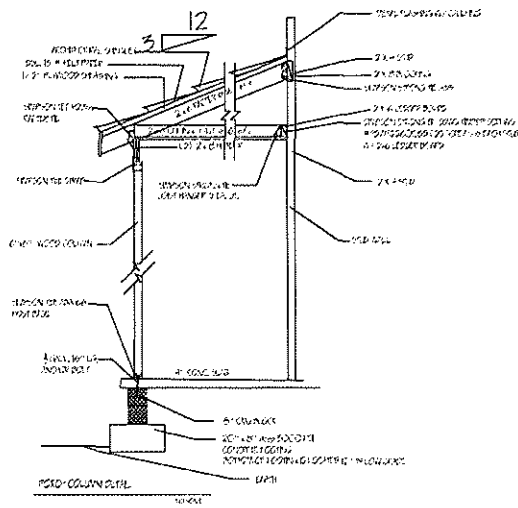
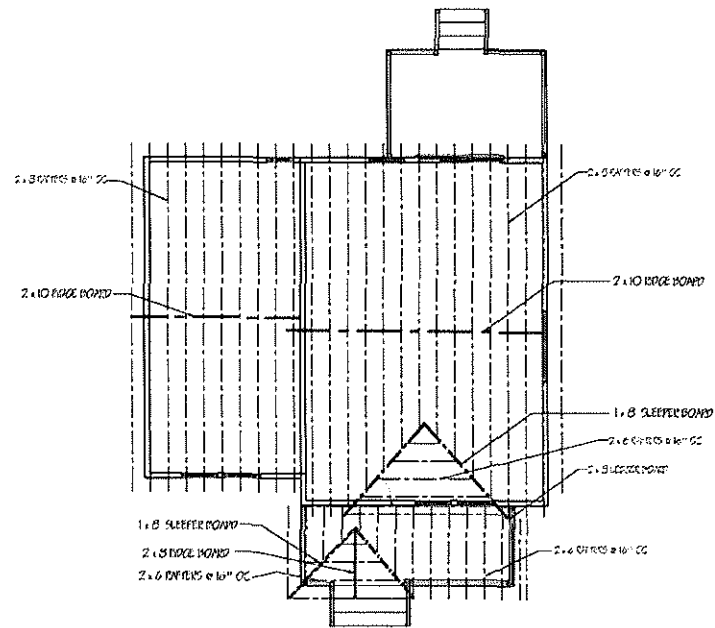

7/15/24
 7/15/24
 PLACEMENT OF LAG SCREWS AND BOLTS IN LEDGERS

Roof Framing Plan

Scale: 1/4" = 1'-0"

REVISIONS

1	
2	
3	

THE DESIGN AND PLAN SHALL BE FOR THE PROJECT ONLY AND ARE THE PROPERTY OF GOLDEN KEYED, LLC. THESE SHALL NOT BE USED FOR ANY OTHER PROJECT WITHOUT THE WRITTEN PERMISSION OF THE DESIGNER.

NEW CONSTRUCTION
 FLOOR PLAN
 LOTS 6 & 7 BOSTON STREET
 HOPEWELL, VA

DATE	3/4/2024
SCALE	1/4" = 1'-0"
GOLDEN KEYED, LLC	
ALIGHA STEVENSON	
6/6	

OCCUPANCY GROUP		RSK
CONSTRUCTION TYPE		SB
WIND LOAD		120 MPH
RACE-7, 3 SEC GUST		EXPOSURE B
SOIL BEARING VALUE		1500 PSF

1st Floor Living Space 799
 2nd Floor Living Space 431
 Total Living Space 1,230

DESIGN LOADS	LIVE LOADS	DEAD LOADS.
LIVING AREAS	40 PSF	10 PSF
SLEEPING AREAS	30 PSF	10 PSF
CEILING JOIST	20 PSF	10 PSF
ROOF AREAS	30 PSF	10 PSF
LIMITED STORAGE	30 PSF	7 PSF

GENERAL NOTES:

- USBC SECTION R310.1.1, WINDOWS FOR EMERGENCY EGRESS: PROVIDE NET OPENING OF 5.7 SQUARE FEET FOR BEDROOMS AND HABITABLE BASEMENT SPACES EXCEPT 5.0 SQUARE FEET FOR GRADE FLOOR WINDOWS. NOTE THAT TO QUALIFY AS GRADE FLOOR WINDOWS THE SILL MUST BE NO HIGHER THAN 44 INCHES ABOVE THE OUTSIDE GRADE DIRECTLY BELOW WINDOW. MINIMUM OPENING SIZE IS 24 INCHES HEIGHT AND 20 INCHES WIDTH. SHOW THE WINDOW SIZES ON THE PLANS.
- USBC SECTION N102.2.3, ATTIC ACCESS INSULATED AND SEALED. ALL ATTIC ACCESS MUST BE REGULATED WITH R VALUE EQUAL TO THE DIAPHRAGM THAT THEY PENETRATE. ALL ACCESSES MUST BE GASKETED AND CONSTRUCTED TO CONTAIN INSULATION SPILL OVER. THIS INCLUDES INCLUDES ATTIC PULL DOWN LADDERS MAY REQUIRE AN INSULATED HATCH AND GASKET.
- ALL FASTENERS FOR PRESSURE TREATED WOOD SHALL BE HOT DIP GALVANIZED STEEL, STAINLESS STEEL, SINCOR BRONZE OR COPPER.
- PROVIDE 1/2" GYPS ON WALLS AND AROUND ANY EXPOSED BEAMS AND OR COLUMNS.

GENERAL CONSTRUCTION NOTES

- CONTRACTOR TO VERIFY ALL FIELD MEASUREMENTS.
- CONTRACTOR TO MATCH EXISTING LEVELS AND MATERIAL SIZE.
- PLAN DON'T HAVE ARCHITECT OR ENGINEER SEAL.
- CONTRACTOR TO MAKE ALL FIELD ADJUSTMENTS BASED ON UNSEEN EXISTING CONDITIONS.
- INSTALL R-15 INSULATION IN OPEN EXTERIOR WALL AND INSTALL R-48 INSULATION IN OPEN CEILING.

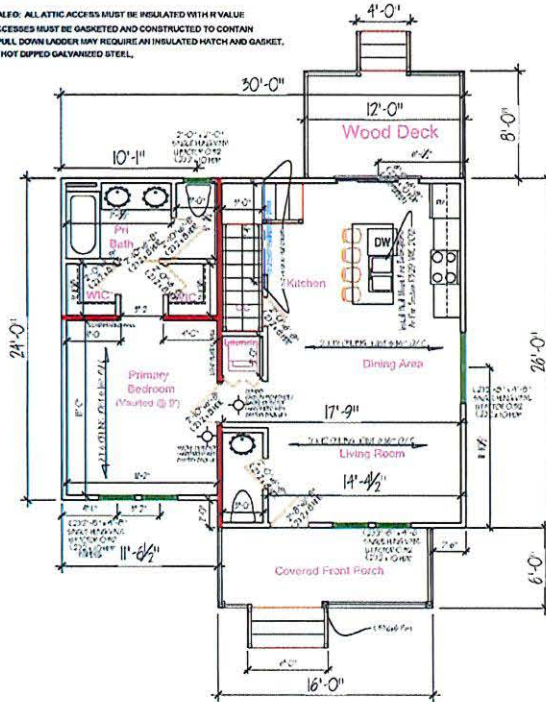

First Floor Plan

Scale: 1/4" = 1'-0"

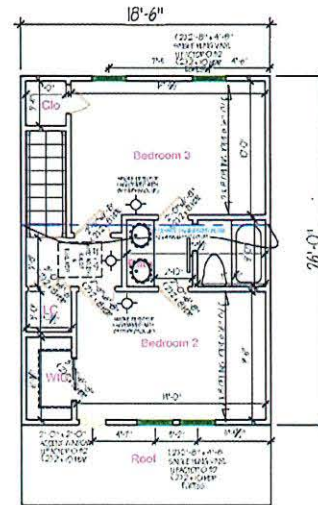
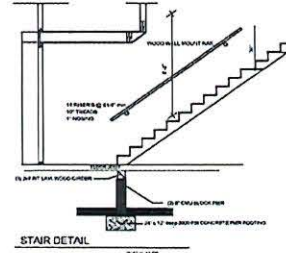

Second Floor Plan

Scale: 1/4" = 1'-0"

REVISIONS

1	
2	
3	

THE DESIGN AND PLANS SHOWN ON THIS PROJECT ONLY AND ARE THE PROPERTY OF THE ARCHITECT. THESE PLANS SHALL NOT BE USED BY ANY PARTY FOR ANY OTHER PROJECT WITHOUT THE WRITTEN PERMISSION OF THE ARCHITECT.

NEW CONSTRUCTION

FLOOR PLAN

LOTS 6 & 7 BOSTON STREET

HOPEWELL, VA

DATE 3/4/2024
 SCALE 1/4"=1'-0"
 GOLDEN KEYS, LLC
 ALISHA STEVENSON

1/6

CONDITIONAL USE PERMIT REQUEST

Single-Family Dwelling on a Non-Conforming Lot

Parcel #033-0020 - Boston St.

CITY COUNCIL

April 23, 2024

CUP REQUEST: SFD on Non-Conforming Parcel #033-0020

- APPLICANT: MewCo LLC
- WARD: 6
- CURRENT ZONING: B-3, SF Dwelling use is under consideration
- REQUEST: Approve CUP request
- PUBLIC NOTICE: Ads in Progress-Index, letters to adjacent property owners



CUP REQUEST: SFD on Non-Conforming Parcel #033-0020



CUP REQUEST: SFD on Non-Conforming Parcel #033-0020

Minimum lot size in R-2 is 75 feet wide and 7,500sf for SFD.

Boston St.– Parcel #033-0020 is 50 feet wide and ~9,000sf.

Non-Conformity – Lot Width is less than 75ft.



CUP REQUEST: SFD on Non-Conforming Parcel #033-0020



- 2-story SF Dwelling
- 3 Bedroom; 2.5 Bath
- 1,240sf

CUP REQUEST: SFD on Non-Conforming Parcel #033-0020

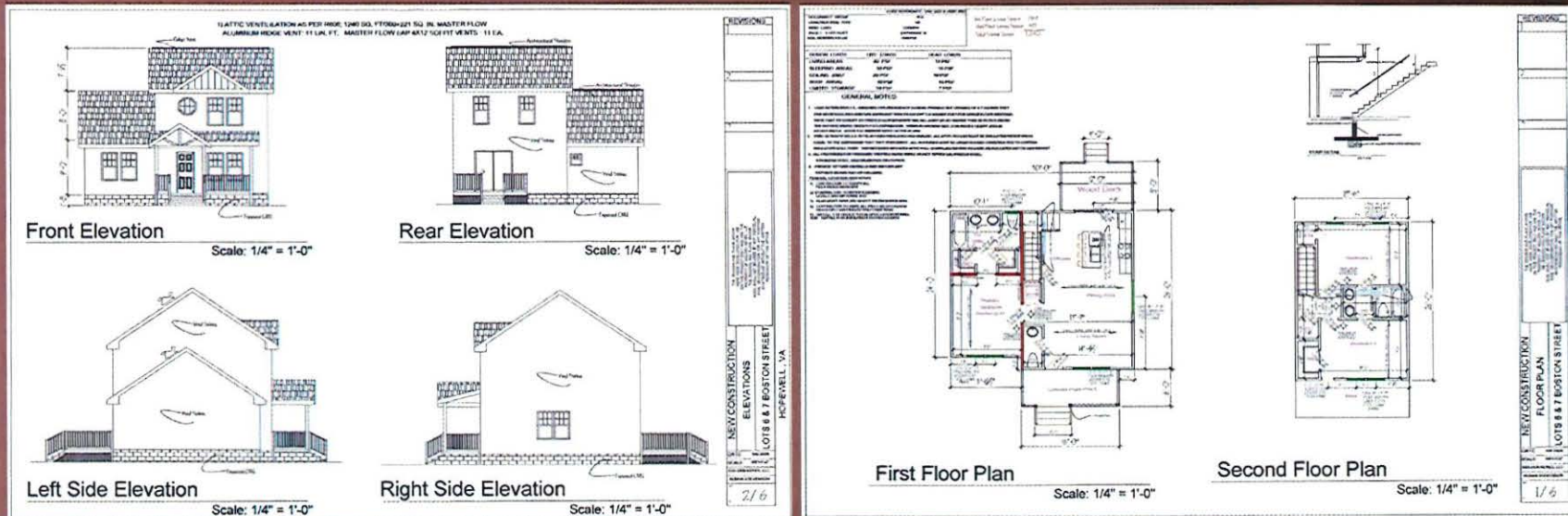

- 2-story SF Dwelling
- 3 Bedroom; 2.5 Bath
- 1,240sf

Staff Analysis

7 CUP Approval Criteria	✓
Comprehensive Plan	✓



- Architectural style of proposed dwelling will enhance neighborhood of primarily vernacular design.
- Average size of dwellings in the surrounding area is 1,139sf.
- Proposed dwelling is 1,240sf.

Staff Recommendation

Staff recommends approval of the CUP with the following conditions:

1. Construction of the proposed dwelling as presented using cement fiber board siding in the patterns illustrated in the house elevation submitted with the application.
2. Installation of concrete or asphalt driveway in accordance with the City's driveway policy.
3. Inclusion of roof overhang/eaves on all roof sides.
4. Ensure 20% lot coverage with tree canopy.

Public
Hearing
April 4,
2024

Planning Commission Recommendation

Planning Commission recommends approval (4-0) of the CUP with the following conditions:

1. Construction of the proposed dwelling as presented using cement fiber board siding in the patterns illustrated in the house elevation submitted with the application.
2. Installation of concrete or asphalt driveway in accordance with the City's driveway policy.
3. Inclusion of roof overhang/eaves on all roof sides.
4. Ensure 20% lot coverage with tree canopy.

Public Comment

Written Comment:

- None

Public Comment (Planning Commission Public Hearing April 4, 2024):

- One citizen commented that she would like to see more windows on the sides of the house.

Recommendation for City Council

Take action after the public hearing tentatively scheduled for

May 14, 2024.

CUP REQUEST: SFD on Non-Conforming Parcel #033-0020

Questions?



**REQUEST FOR CONDITIONAL USE PERMIT
TO CONSTRUCT A SINGLE-FAMILY DWELLING ON
NON-CONFORMING LOT, PARCEL # 033-0020
LOCATED ON BOSTON STREET**



CITY COUNCIL

STAFF REPORT

Staff from the Hopewell Department of Development has drafted this report to assist City leadership with making informed decisions regarding land use cases in Hopewell.

I. APPLICANT: MewCo LLC, 4606 Chippoake Rd., Chester, VA 23831

II. EXECUTIVE SUMMARY

The applicant, MewCo, LLC, requests a Conditional Use Permit to construct a single-family dwelling on the non-conforming Parcel #033-0020 located on Boston Street in the Dupont Annex Neighborhood. Staff recommends approval with conditions.

III. TENTATIVE SCHEDULE OF MEETINGS

BODY	EST. DATE	TYPE	RESULT
Planning Commission	April 4, 2024	Public Hearing	Pending
City Council	April 23, 2024	1 st Reading	No Action
City Council	May 14, 2024	2 nd Reading / PH	Pending

IV. IDENTIFICATION AND LOCATIONAL INFORMATION

Existing Zoning	R-2 – Residential Medium Density
Requested Zoning	N/A
Acreage	0.206 acres / 9,000 sf
Legal Description	LOTS 6-7 BLK 4 SUBDIVISION: DUPONT ANNEX SEC 2
Election Ward	1
Future Land Use	Urban Residential
Strategic Plan Goal	Housing
Approval Method	City Council Resolution
Can Conditions be Set?	Yes
Map Location	Parcel #033-0020

V. PUBLIC NOTIFICATION

PUBLIC HEARING	NOTIFICATION TYPE	DATE	DATE
Planning Commission	Progress-Index Ad	3/27/24	4/3/2024
	Letter to Adj. Properties	3/25/2024	
City Council – 1 st Read	Progress-Index Ad	N/A	N/A
	Letter to Adj. Properties	N/A	
City Council PH	Progress-Index Ad	TBD	TBD
	Letter to Adj. Properties	TBD	

VI. ROLE OF PLANNING COMMISSION AND CITY COUNCIL

Excerpted and paraphrased from *Handbook for Virginia Mayors & Council Members*

Within each zoning district some uses are permitted as a matter of right and others are only conditionally permitted. The theory behind the conditional use approach is that the particular use has a certain level of negative externality which, if properly managed, could allow the use to be established in the district. Absent proper management, conversely, the use is most likely unacceptable. The Conditional Use Permit process affords a case-by-case review. It is up to the local governing body to establish the conditions under which the Conditional Use Permit is to be approved; applicants/property owners are not required to agree to the conditions imposed for them to be valid and binding on the property. The question being considered is whether the proposed use in the proposed location can be conditioned in such a way as to prevent negative externalities from being imposed on adjacent and nearby properties. Possible negative externalities can comprise a long list that are often spelled out in the ordinance – smoke, dust, noise, trash, light, traffic, incompatible activity levels or hours of operation, likelihood of trespass on adjoining properties, stormwater/drainage runoff, inadequate public infrastructure, and many more.

Conditional Use Permits in Hopewell run with the land and not the owner.

VII. APPLICABLE CODE SECTIONS

1. [Article XVII, Non-Conforming Uses, Section F, Non-Conforming Lots of Record](#)
2. [Article XXI, Amendments, Section D, Conditional and Special Use Permits](#)

VIII. SUBJECT PROPERTY

The subject property, Parcel #033-0020, is a non-conforming lot on Boston Street near the intersection with Arlington Road. The property dimensions are 50 feet wide by 180 feet deep for a total of 9,000 square feet. The R-2 Residential Medium Density District sets the minimum

lot width at 75 feet and the minimum lot size for a single-family dwelling at 7,500 square feet. The lot width is less than the required minimum, making it non-conforming to the R-2 District.

IX. APPLICANT POSITION

The applicant proposes to construct a 1,240 square foot, two-story, single-family dwelling on the property. The proposed dwelling will have a mix of horizontal and vertical (board and batten) fiber cement board siding with an asphalt shingle roof. An accent foundation wall of stone is also proposed. The applicant argues that the proposed dwelling conforms to the neighborhood and is consistent with the Comprehensive Plan by adding new market rate housing to Hopewell's housing stock. In addition, the applicant argues that adding a high-quality modern starter single-family home to this vacant lot will enhance the neighborhood's appeal and pride.

NOTE: The garage shown on the elevation will not be an element of the proposed dwelling. The area shown as the garage will be the primary bedroom (see floor plan).

X. STAFF ANALYSIS

When considering a conditional use permit, one must consider the seven conditions outlined in Article XXI of the Zoning Ordinance (see attachment). Conditions may be mandated to ensure the character of the neighborhood and zoning district in which the use is locating will not be adversely affected. Such conditions may address architectural style, materials, landscaping, enhanced storm water management, or any other required condition that mitigates any potential negative impact with the goal of maintaining or enhancing the surrounding neighborhood.

The Hopewell Zoning Ordinance requires that approved structures on non-conforming lots must adhere to the district's setbacks. The required setbacks in the R-2 District are as follows:

- 25ft. – front yard.
- 10ft. – interior side yard; 15ft. – corner side yard.
- 25ft. – rear yard.

The parcel has a buildable area that is 30ft x 130ft (3,900sf) after applying the required setbacks.

The lot is 25 feet narrower than the minimum lot width of 75 feet in the R-2 district. The neighborhood at large consists of lots ranging from 40-100 feet wide.

XI. RELATIONSHIP TO THE COMPREHENSIVE PLAN

AGE OF HOUSING

Hopewell has seen lower levels of new development in recent decades when compared to other cities in the region and state, with a drastic slowdown beginning in the 1980s. For this reason, the city now has an aging stock of housing units, with nearly 80% of all units built in the 1970s or earlier (Hopewell Comprehensive Plan 2018, pg. 202).

THE FUTURE LAND USE PLAN

Stable areas are fully built-out and are not viewed as available strategic opportunity areas for future growth. This leaves infill development and redevelopment employing Traditional Neighborhood Design (TND) and Urban Development Area (UDA) principles as the land use form upon which City leaders must focus. It is important to distinguish between the two. Infill attempts to “seed” (or catalyze) a progressive movement to gradually upgrade the value and attractiveness of a given neighborhood or commercial area. Redevelopment focuses on larger properties or groups of properties that are substantially deteriorated or vacant, with potential economic value for the entire community.

Infill development and redevelopment projects can have substantial benefits for Hopewell. This will not occur without City guidance and planning initiatives. Communities that have pursued active infill and redevelopment programs have realized a strengthening of their real estate market by renewing housing stock and readapting sub-standard neighborhoods and sub-par commercial areas. (Hopewell Comprehensive Plan 2018, pg. 117).

XII. STAFF RECOMMENDATION

A survey of the properties in the surrounding neighborhood reveals a homogeneous stock of one-story homes with vinyl siding. The houses along Wall Avenue are mostly of this one-story size but also include a 1.5-story and two-story dwelling. The average size of the neighborhood dwellings is 1,139sf. The proposed house will be larger than the average size at 1,240sf. Considering all these factors, Staff cites Article XXI, Section D, Item d(4), Approval Criteria, which states:

“As may be specified within each zoning district, uses permitted subject to conditional use review criteria shall be permitted only after review by the Planning Commission and approval by the City Council only if the applicant demonstrates that:

4. The proposed conditional use conforms to the character of the neighborhood within the same zoning district in which it is located. The proposal as submitted or modified

shall have no more adverse effects on health, safety or comfort of persons living or working in or driving through the neighborhood, and shall be no more injurious to property or improvements in the neighborhood, than would any other use generally permitted in the same district. In making such a determination, consideration shall be given to location, type, size, and height of buildings or structures, type and extent of landscaping and screening on the site, and whether the proposed use is consistent with any theme, action, policy or map of the Comprehensive Plan.”

For these reasons, Staff supports the approval of this application with the following conditions:

- a. The proposed dwelling as presented is to be constructed using cement fiber board siding in the patterns illustrated in the house elevation submitted with the application.
- b. A driveway of concrete or asphalt will be installed in accordance with the City’s driveway policy.
- c. The dwelling will have a roof overhang/eaves on all sides.
- d. The applicant will ensure a tree canopy of at least 20% lot coverage.

XIII. PLANNING COMMISSION RECOMMENDATION

The Hopewell Planning Commission voted 4-0 at the April 4, 2024 meeting to recommend approval of the CUP request with the following conditions:

- a. The proposed dwelling as presented is to be constructed using cement fiber board siding in the patterns illustrated in the house elevation submitted with the application.
- b. A driveway of concrete or asphalt will be installed in accordance with the City’s driveway policy.
- c. The dwelling will have a roof overhang/eaves on all sides.
- d. The applicant will ensure a tree canopy of at least 20% lot coverage.

XIV. PUBLIC COMMENT

No public comments were offered at the Planning Commission public hearing held on April 4, 2024.

The Development Department received one emailed comment on Thursday, April 4, 2024 at 6:18PM from Laura Deloatche, 1117 Wall Ave., stating that she is against the construction of a single-family dwelling on Parcel #033-0020. No specific reason was given.

APPENDIX A - MAPS

CITY LOCATIONAL MAP – Yellow Circle indicates general area

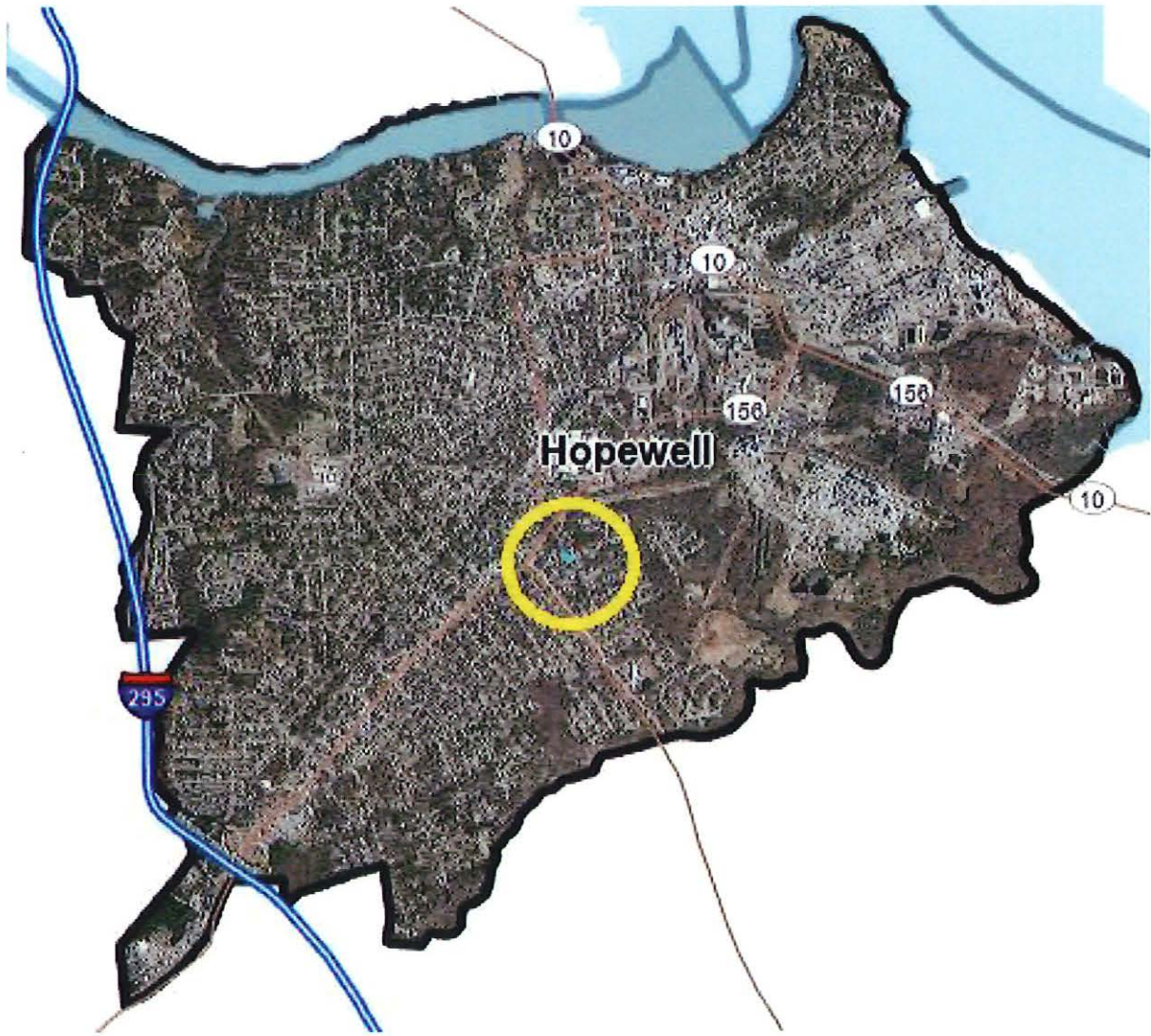

PROPERTY LOCATION – Red box indicates Parcel #033-0020



APPENDIX B – SURROUNDING AREA DATA

SURROUNDING PROPERTIES - PARCEL #079-0005									
WALL & BOSTON									
	ADDRESS	STORIES	HOUSE SQ FT	WIDTH	DEPT H	LOT SQ FT	MATERIAL	YR BUILT	TYP E
1	1110 WALL	1	1056	139	94	13,066	WOOD	1993	SF
2	1111 WALL	2	1560	75	90	6,750	VINYL	2007	SF
3	1112 WALL	1	1056	92	83	7,636	VINYL	1993	SF
4	1113 WALL	1.5	1372	65	90	5,850	VINYL	2006	SF
5	1114 WALL	1	1056	82	93	7,626	VINYL	1994	SF
6	1115 WALL	1	1022	85	100	8,500	VINYL	1991	SF
7	1116 WALL	1	1056	75	100	7,500	VINYL	1994	SF
8	1117 WALL	1	1056	75	100	7,500	MASONITE VINYL/WOOD	1991	SF
9	1205 WALL	1	1497	100	100	10,000	D	1997	SF
10	2520 BOSTON	1	791	50	100	5,000	VINYL	1951	SF
11	2522 BOSTON	1	1008	75	100	7,500	ASBESTOS	1951	SF
	AVERAGE	1	1,139	83	95	7,901	VINYL		
	#033-0020	2	1240	50	180	9,000	FIBER CEMENT		SF

BLUE = Proposed house

R-2



CITY OF HOPEWELL CITY COUNCIL ACTION FORM

Strategic Operating Plan Vision Theme:

- Civic Engagement
- Culture & Recreation
- Economic Development
- Education
- Housing
- Safe & Healthy Environment
- None (Does not apply)

Order of Business:

- Consent Agenda
- Public Hearing
- Presentation-Boards/Commissions
- Unfinished Business
- Citizen/Councilor Request
- Regular Business
- Reports of Council Committees

Action:

- Approve and File
- Take Appropriate Action
- Receive & File (no motion required)
- Approve Ordinance 1st Reading
- Approve Ordinance 2nd Reading
- Set a Public Hearing
- Approve on Emergency Measure

COUNCIL AGENDA ITEM TITLE: Conditional Use Permit Request to Construct a Single-Family Dwelling on Non-Conforming Lot, Parcel #028-0020 on Crescent Ave.

ISSUE: City ordinance requires CUP approval to construct a single-family dwelling on non-conforming lots. All setbacks must be met.

RECOMMENDATION: City Administration recommends no action at this time.

TIMING: City Council is requested on May 14, 2024

BACKGROUND: See enclosed documents

ENCLOSED DOCUMENTS: CUP application, staff report, presentation

STAFF: Christopher Ward, Director of Development

FOR IN MEETING USE ONLY

MOTION: _____

Roll Call**SUMMARY:**

Y	N		Y	N	
<input type="checkbox"/>	<input type="checkbox"/>	Councilor Rita Joyner, Ward #1	<input type="checkbox"/>	<input type="checkbox"/>	Councilor Janice Denton, Ward #5
<input type="checkbox"/>	<input type="checkbox"/>	Councilor Michael Harris, Ward #2	<input type="checkbox"/>	<input type="checkbox"/>	Councilor Brenda Pelham, Ward #6
<input type="checkbox"/>	<input type="checkbox"/>	Mayor John B. Partin, Ward #3	<input type="checkbox"/>	<input type="checkbox"/>	Councilor Dominic Holloway, Sr., Ward #7
<input type="checkbox"/>	<input type="checkbox"/>	Vice Mayor Jasmine Gore, Ward #4			



The City
of
Hopewell, Virginia

300 N. Main Street · Department of Development · (804) 541-2220 · Fax: (804) 541-2318

CONDITIONAL USE PERMIT APPLICATION

APPLICATION FEE: \$300

APPLICATION #

APPLICANT: James B. Jones

ADDRESS: P.O. Box 1402
Hopewell, VA 23860

PHONE #: 804.541.8000 FAX #: 804.541.8775

EMAIL ADDRESS: tara@jrjbuilder.com

INTEREST IN PROPERTY: OWNER OR AGENT
IF CONTRACT PURCHASER, PROVIDE A COPY OF THE CONTRACT OR A LETTER
OF THE PROPERTY OWNER'S CONSENT TO MAKE APPLICATION.

OWNER: _____

ADDRESS: _____

PHONE #: _____ FAX #: _____

PROPERTY ADDRESS / LOCATION:

lots 13, 14, & 15, Block 1, Crescent Hill

PARCEL #: 0280020 ACREAGE: .204 ZONING: R1

*** IF REQUIRED BY ARTICLE 16 OF THE ZONING ORDINANCE, ***
A SITE PLAN MUST ACCOMPANY THIS APPLICATION

ATTACH A SCALED DRAWING OR PLAT OF THE PROPERTY SHOWING:

1. FLOOR PLANS OF THE PROPOSED BUILDINGS. 1700+ sq. ft.
2. THE PROPOSED DEVELOPMENT WITH FRONT, SIDE, AND REAR ELEVATIONS. plat.

THIS REQUEST FOR A CONDITIONAL USE PERMIT IS FILED UNDER SECTION _____ OF THE ZONING ORDINANCE.

PRESENT USE OF PROPERTY:

vacant lots

THE CONDITIONAL USE PERMIT WILL ALLOW:

the lots to become one buildable lot.

PLEASE DEMONSTRATE THAT THE PROPOSAL AS SUBMITTED OR MODIFIED WILL NOT AFFECT ADVERSELY THE HEALTH, SAFETY, OR WELFARE OF PERSONS RESIDING OR WORKING IN THE NEIGHBORHOOD OF THE PROPOSED USE.

This proposal will not affect the surrounding homes negatively. Rather it will increase their home values.

PLEASE DEMONSTRATE THAT THE PROPOSAL WILL NOT BE DETRIMENTAL TO PUBLIC WELFARE OR INJURIOUS TO THE PROPERTY OR IMPROVEMENTS IN THE NEIGHBORHOOD.

This proposal will not be detrimental to the public and will increase home sales to the surrounding homes.

PLEASE DEMONSTRATE HOW THE PROPOSAL AS SUBMITTED OR MODIFIED WILL CONFORM TO THE COMPREHENSIVE PLAN AND THE PURPOSES AND THE EXPRESSED INTENT OF THE ZONING ORDINANCE.

We would like to build a home comparable to the area - similar to a Sears home.

AS OWNER OF THIS PROPERTY OR THE AUTHORIZED AGENT THEREFOR, I HEREBY CERTIFY THAT THIS APPLICATION AND ALL ACCOMPANYING DOCUMENTS ARE COMPLETE AND ACCURATE TO THE BEST OF MY KNOWLEDGE.



APPLICANT SIGNATURE

2.21.2024
DATE

Tara M. Jones

APPLICANT PRINTED NAME

OFFICE USE ONLY

DATE RECEIVED _____ DATE OF ACTION _____

APPROVED _____ DENIED

APPROVED WITH THE FOLLOWING CONDITIONS:

**Addendum to the request for Conditional Use Permit for
PID # 0280020 on Crescent Avenue**

1. Present use of property: vacant lots (14 to 16) with poor drainage to a slopping ravine.
2. The conditional use permit will allow: the lots to become one 75 foot frontage, buildable single-family parcel. The proposed house plan is within the average square footage of the surrounding properties at 1659 sq. ft.
3. Please demonstrate that the proposal as submitted or modified will not affect adversely the health, safety or welfare of persons residing or working in the neighborhood of the proposed use: The proposal will not affect the surrounding homes negatively in regards to structure, style, quality and/ or environmental standards. It will promote home ownership in the area, increase neighboring home values and provide additional revenue to the City.
4. Please demonstrate that the proposal will not be detrimental to public welfare or injurious to the property or improvements in the neighborhood: This proposal will not be detrimental to the public welfare or injurious to the property. We plan to keep as many mature trees as possible onsite without the need for replanting. In addition to, we plan to properly evaluate the drainage issue and repair/ replace any areas of concern with suitable erosion control measures to eliminate the existing matter.
5. Please demonstrate how the proposal as submitted or modified will conform to the comprehensive plan and the purposes and the expressed intent of the zoning ordinance: We plan to construct a Tudor-style home equivalent to the surrounding area. The livable square footage is 1659 sq. ft. The exterior of the home would complement the modern style Tudor homes with an archtop doorway, grouped windows with wide case trim, and a mixture of vinyl shake and stone veneer on the front exterior. The remaining exterior of the home would be vinyl siding with a brick foundation. Due to the limited buildable footprint, the square footage cannot exceed the current proposed house plan without altering the design of a Tudor style home.











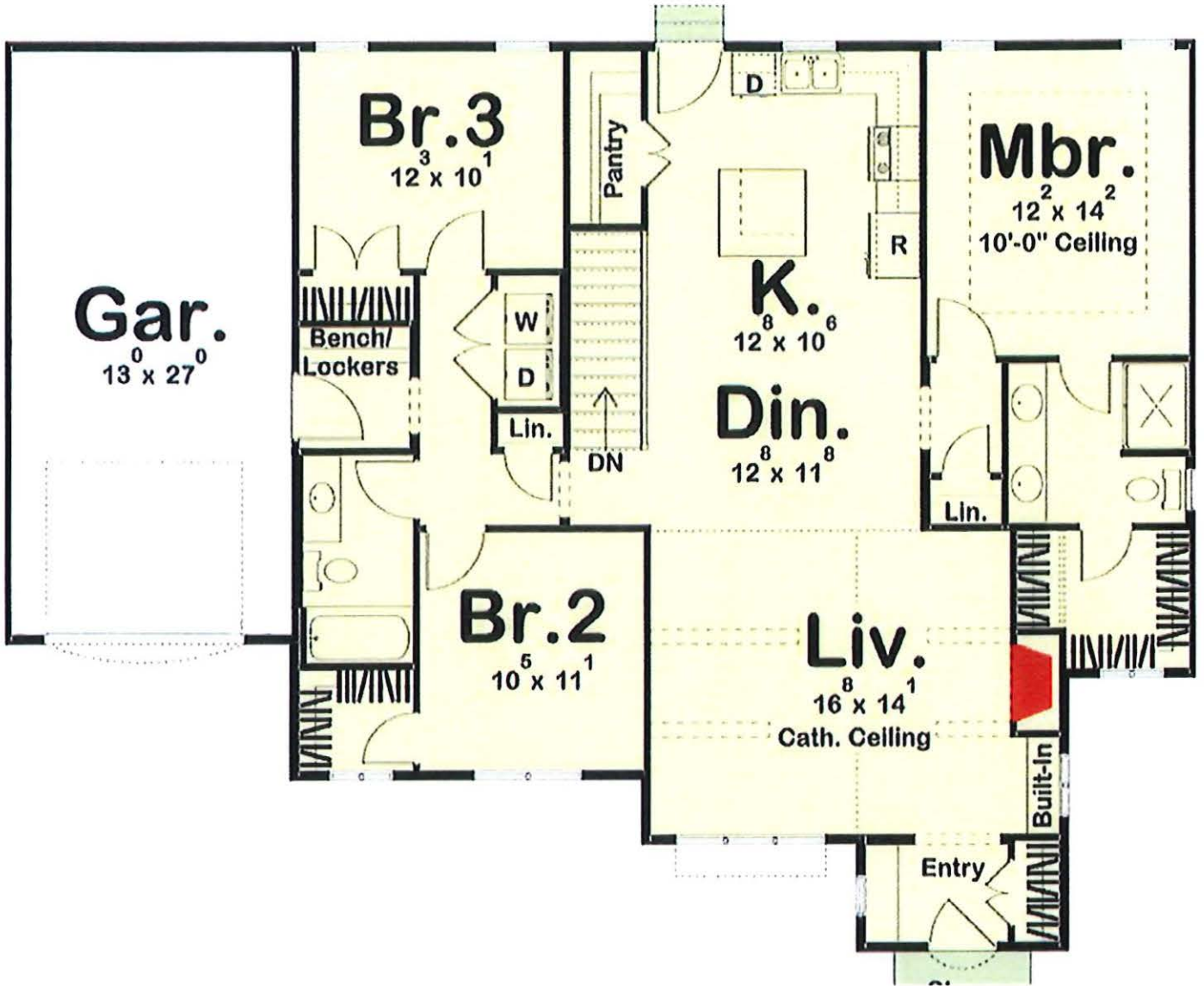

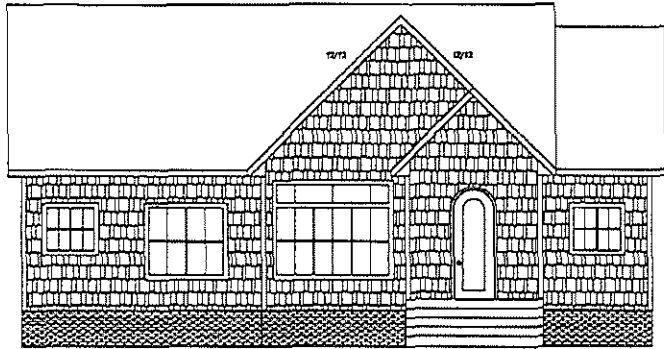

FRONT ELEVATION

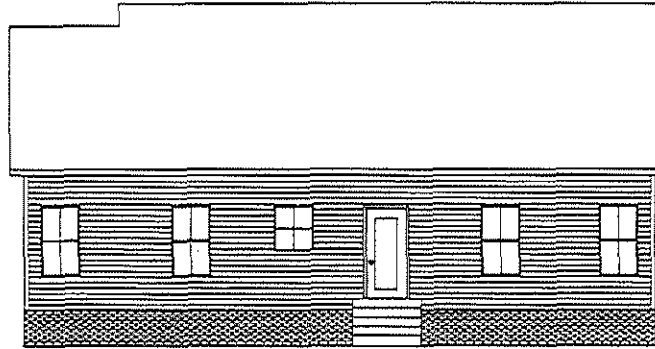

REAR ELEVATION

CD80 IRC/IBC 2003
 LOADING
 FLOOR
 LIVE LOAD 40PSF
 DEAD LOAD 10PSF
 ROOF
 LIVE LOAD 20PSF
 DEAD LOAD 10PSF

DATE: 2-2-24
 DESIGNER: CAS
 SCALE: 1/4" = 1'

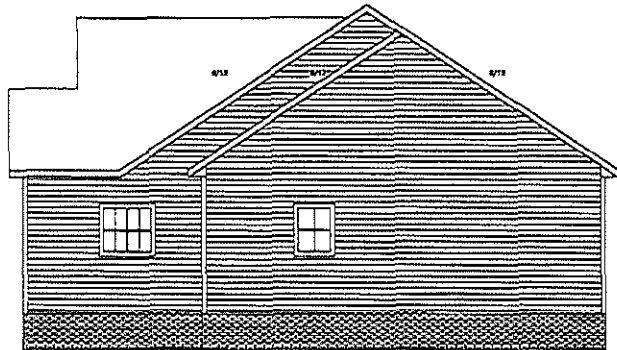

RIGHT ELEVATION

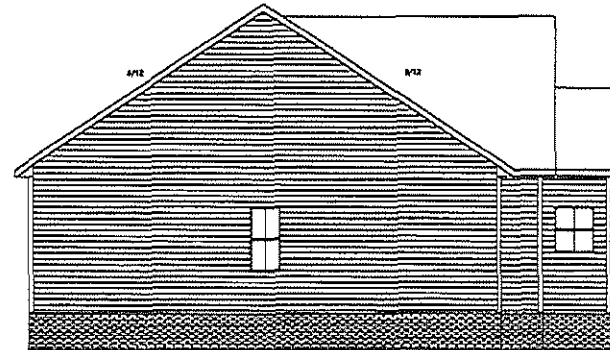

LEFT ELEVATION

CRESENT AVE
 DRAWN BY:
 Chris Smiley
 21565 Black Creek Road
 Franklin, Va. 23851

A-1

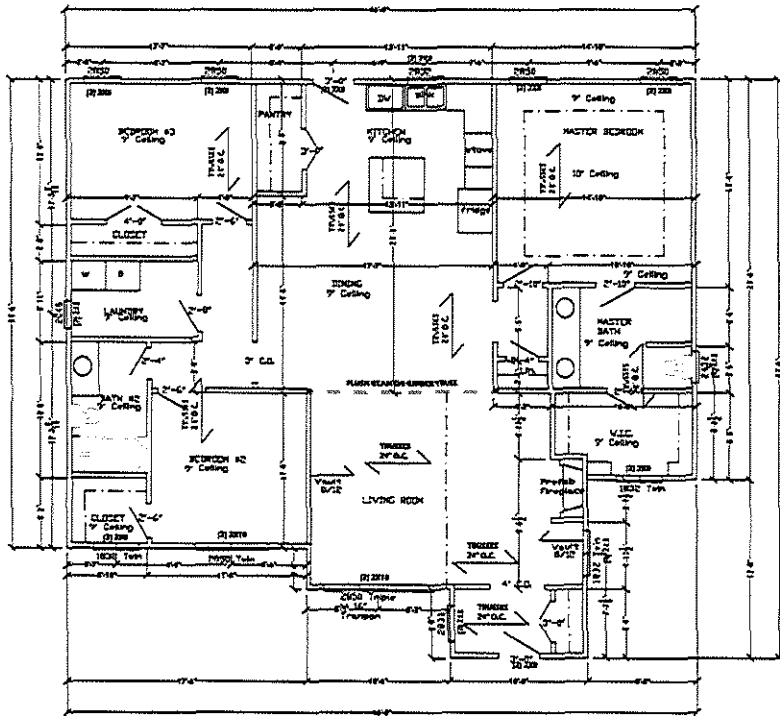

FIRST FLOOR PLAN

FIRST FLOOR SQ. FT = 1659

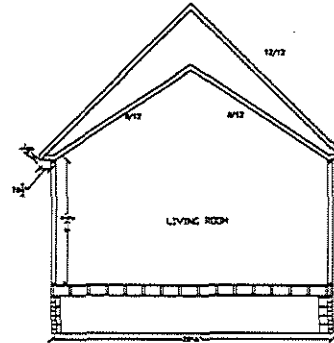

CUT THRU

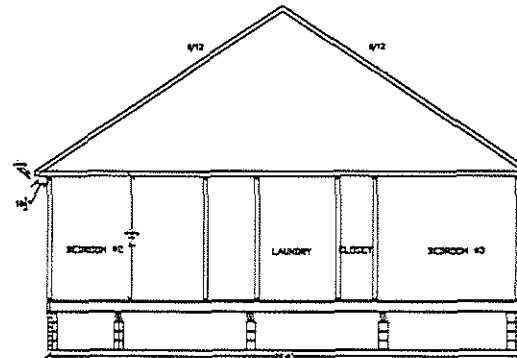

CUT THRU

DATE: 2-21-26	SCALE: 1/4" = 1'
DESIGNER: CAS	

CRESENT AVE

DRAWN BY:
 Chris Salley
 21565 Black Creek Road
 Franklin, Va. 23851

A-2

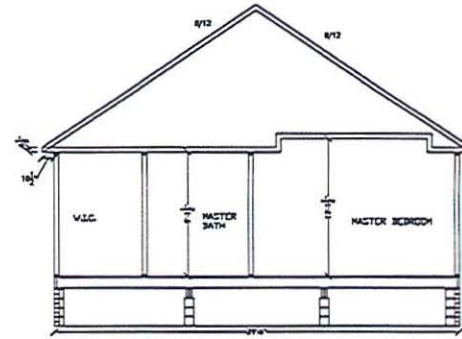
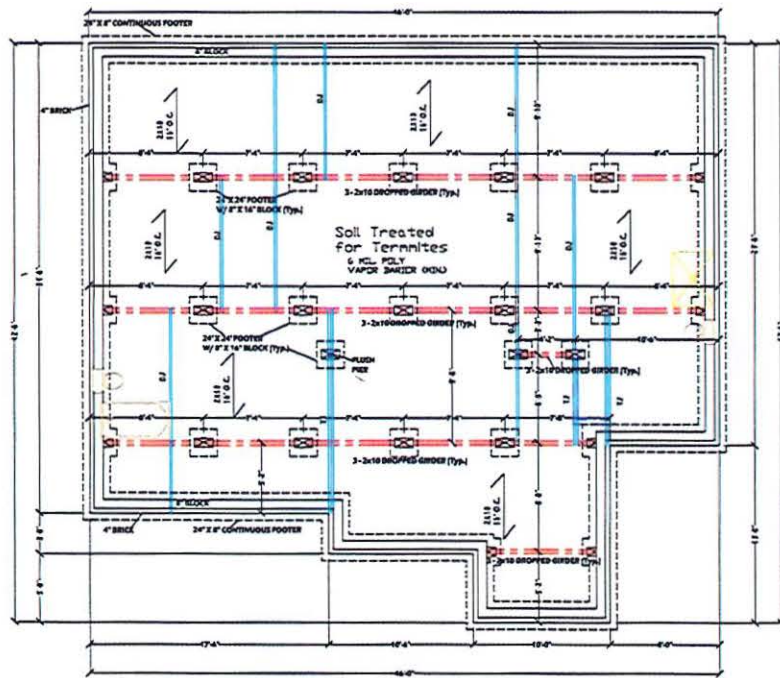

CUT THRU

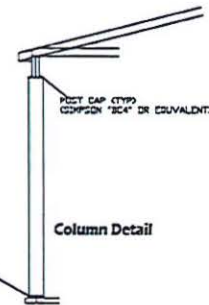

**SIMPSON POST BASE
AS PER OR EQUIVALENT
FACTORY TO COLUMN PER
MANUFACTURER'S SPEC'S
& 3/8\"/>**

Column Detail

FOUNDATION & 1ST FLOOR FRAMING PLAN

1. Double Joist under All Parallel
Partition Walls Unless Noted Otherwise.

DATE: 2-21-24	DESIGNER: CAS	SCALE: 1/4" = 1'
---------------	---------------	------------------

CRESENT AVE

DRAWN BY:
Chris Smiley
21565 Black Creek Road
Franklin, Va. 23851

A-3

- Roof Ventilation Section VRC R806 1 sq ft per 150

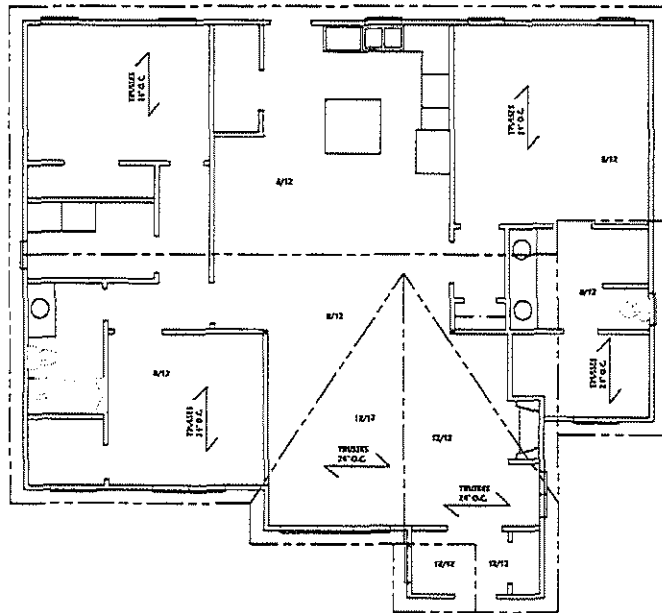

ROOF PLAN

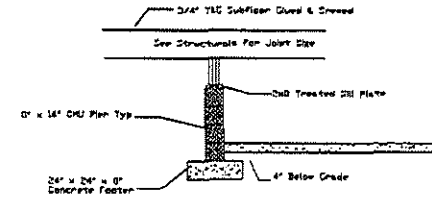

Typ. Pier & Girder Detail

DETAILS

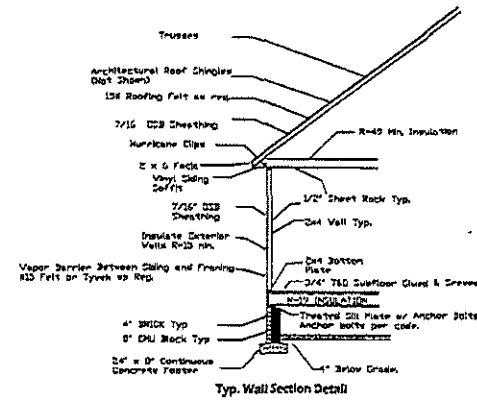

Typ. Wall Section Detail

DATE: 2-21-24	DESIGNER: CAS	SCALE: 1/4" = 1'
---------------	---------------	------------------

CRESENT AVE

DRAWN BY:
Chris Smiley
21565 Black Creek Road
Franklin, Va. 23851

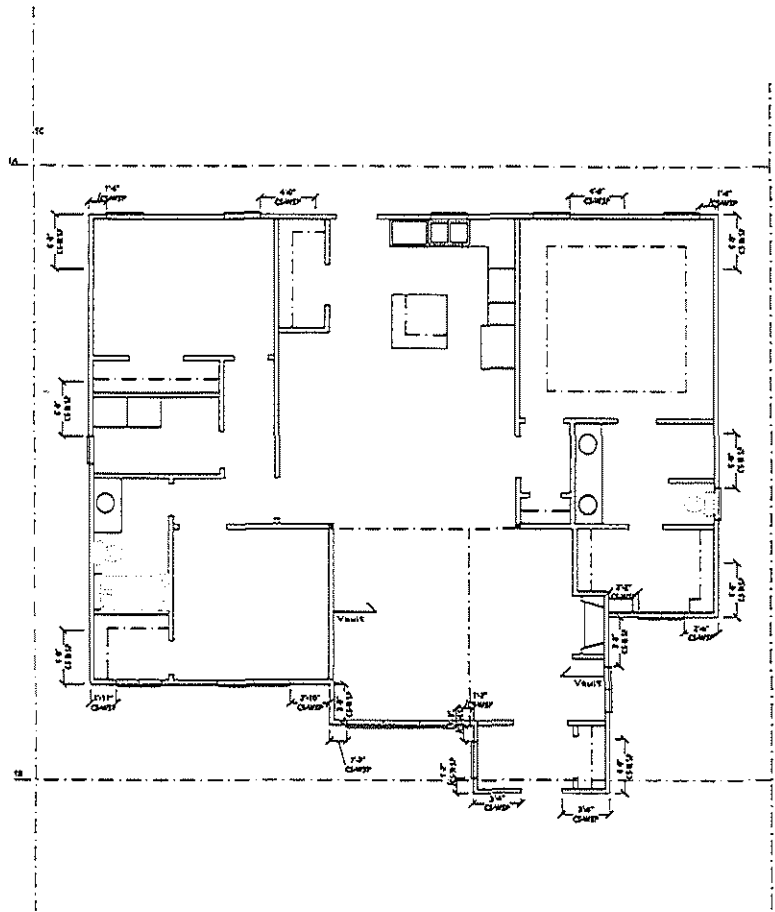

FIRST FLOOR WALL BRACING



1. MAX. 1" SPACING BETWEEN PICKETS
 2. 3.25" TALL RAILS
 RAIL DETAIL FOR PORCHES AND LANDINGS OVER 24" TALL

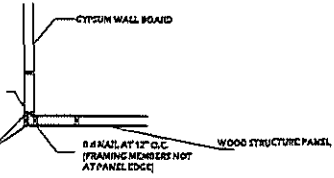
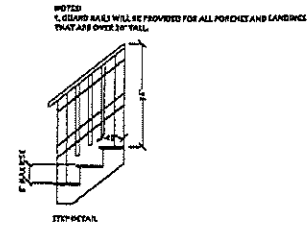

OUTSIDE CORNER DETAIL

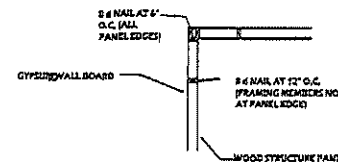

INSIDE CORNER DETAIL

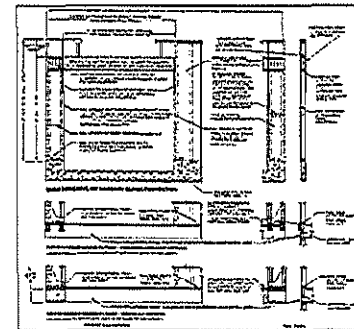

FIGURE R602.10.6.4 METHOD CS-PF - CONTINUOUSLY SHEATHED PORTAL FRAME PANEL CONSTRUCTION

DATE: 2-21-24
 DESIGNER: CAS
 SCALE: 1/4" = 1'

CRESENT AVE

BRAN BY:
 Chris Salley
 21565 Black Creek Road
 Franklin, Va. 23851

A-5

CONDITIONAL USE PERMIT REQUEST

Single-Family Dwelling on a Non-Conforming Lot

Parcel #028-0020 - Crescent Ave.

CITY COUNCIL

April 23, 2024

CUP REQUEST: SFD on Non-Conforming Parcel #028-0020

- APPLICANT: James R. Jones
- WARD: 3
- CURRENT ZONING: R-1 Residential Low Density
- REQUEST: Approve CUP request
- PUBLIC NOTICE: Ads in Progress-Index, letters to adjacent property owners, sign placed at property

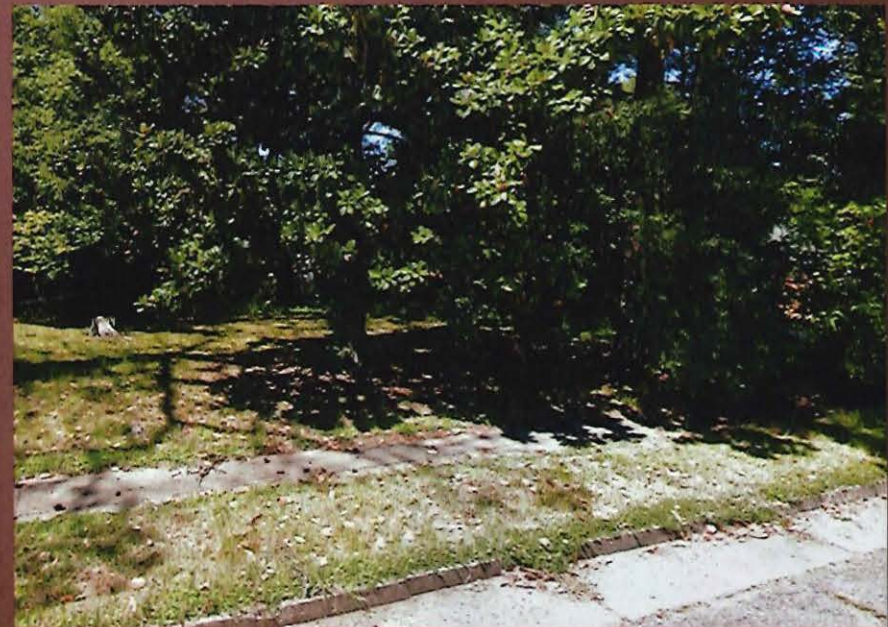

CUP REQUEST: SFD on Non-Conforming Parcel #028-0020

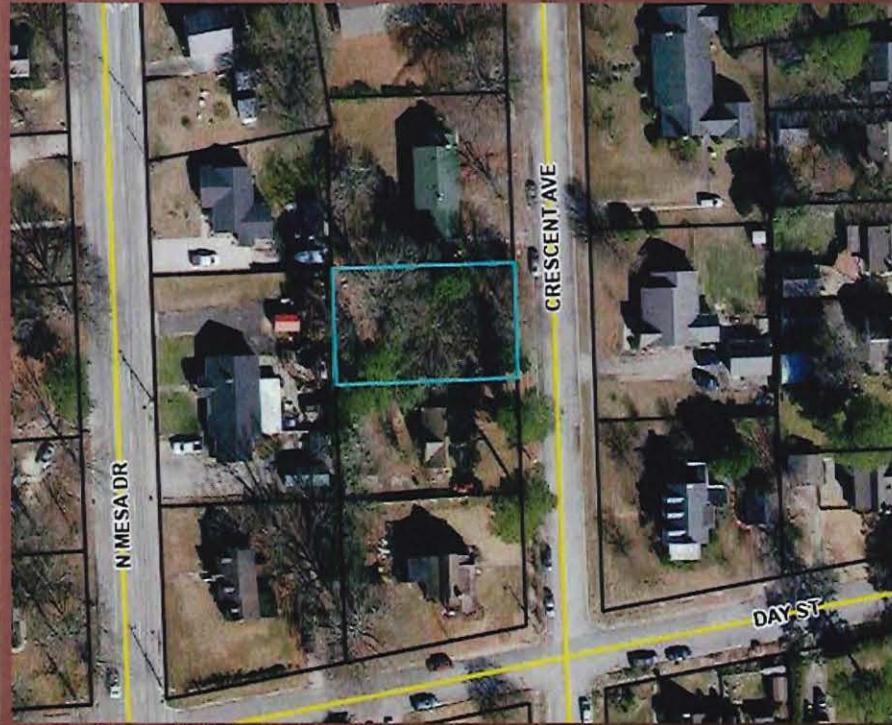
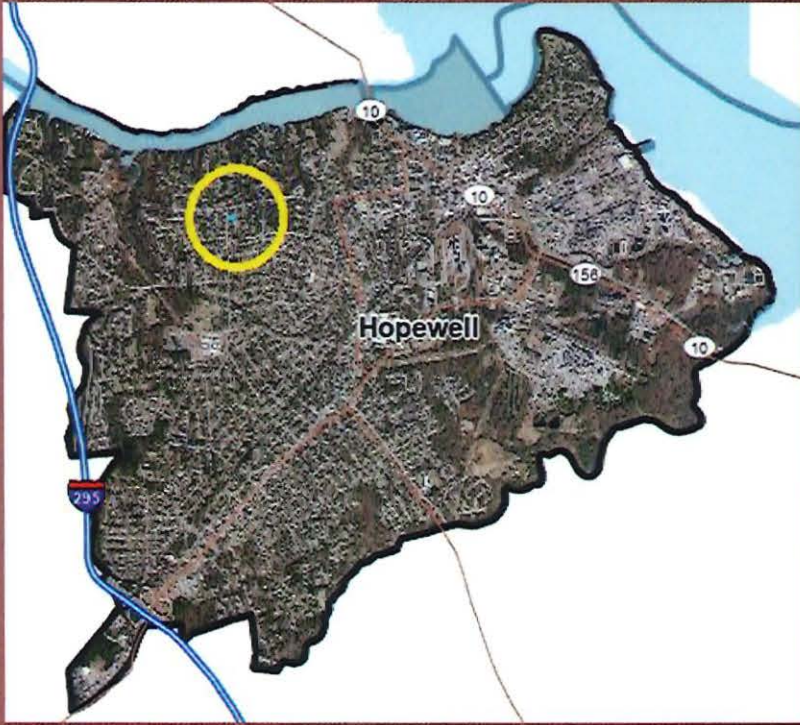

CUP REQUEST: SFD on Non-Conforming Parcel #028-0020

Minimum lot size in R-1 is 80 feet wide and 12,000sf.

Crescent Ave – Parcel #028-0020 is 75 feet wide and 8,850sf.

Non-Conformity – Total Lot Size less than 12,000sf. & lot width less than 80ft.



CUP REQUEST: SFD on Non-Conforming Parcel #028-0020

- 1-Story SF Dwelling
- 3 Bedroom; 2 Bath
- 1,659sf

Garage will **not** be constructed



CUP REQUEST: SFD on Non-Conforming Parcel #028-0020

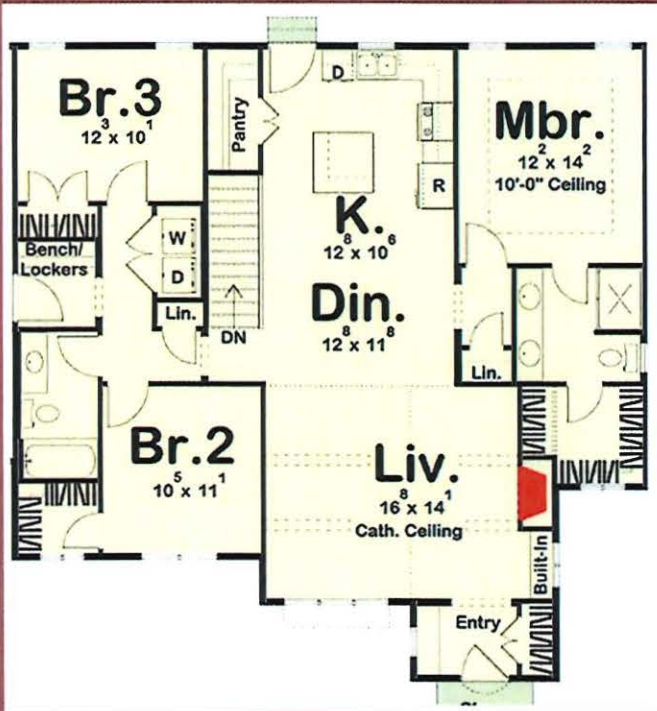

Staff Analysis

7 CUP Approval Criteria	✓
Comprehensive Plan	✓



- Proposed dwelling is of a unique architectural style (Cottage) that complements varied architecture in the neighborhood.
- Average size of dwellings in the surrounding area is 1,695 sf.
- Proposed dwelling is 1,659sf.
- Smaller lot size + steep slopes in rear limit options.

Staff Recommendation

Staff recommends approval of the CUP with the following conditions:

1. Construct proposed dwelling as presented (minus garage) including stone veneer covering full façade of front door project including sides and vinyl shake siding on all other front facades.
2. Install horizontal vinyl siding on all other building facades.
3. Include minimum of 4" wide trim around all front façade doors and windows.
4. Install 3-paned front window with 3-paned transom as shown.
5. Construct driveway of asphalt or concrete in accordance with City's driveway policy.
6. Include roof overhand/eaves on all roof sides.
7. Ensure 20% tree canopy lot coverage.
8. Include all other proffered features noted in application Addendum dated March 11, 2024.

Planning Commission Recommendation

Planning Commission recommends approval (4-0) of the CUP with the following conditions:

1. Construct proposed dwelling as presented (minus garage) including stone veneer covering full façade of front door project including sides and vinyl shake siding on all other front facades.
2. Install horizontal vinyl siding on all other building facades.
3. Include minimum of 4" wide trim around all front façade doors and windows.
4. Install 3-paned front window with 3-paned transom as shown.
5. Construct driveway of asphalt or concrete in accordance with City's driveway policy.
6. Include roof overhang/eaves of 12" on all roof sides.
7. Ensure 20% tree canopy lot coverage.
8. Include all other proffered features noted in application Addendum dated March 11, 2024.

Planning Commission Recommendation (Cont'd)

9. Install brick veneer on all foundation sides.
10. Include all other proffered features cited in the Application Addendum submitted by the applicant on March 11, 2024.
11. Coordinate with the City's Stormwater Division on the armoring of the ravine and proper storm drainage.

Public Comment

Written Comment:

- None

Public Comment (Planning Commission Public Hearing April 4, 2024):

- One citizen commented that the applicant is a quality builder and is confident that the applicant will construct a quality home.

Recommendation for City Council

Take action after the public hearing tentatively scheduled for

May 14, 2024.

CUP REQUEST: SFD on Non-Conforming [Parcel #028-0020](#)

Questions?



**REQUEST FOR CONDITIONAL USE PERMIT
TO CONSTRUCT A SINGLE-FAMILY DWELLING ON
NON-CONFORMING LOT, PARCEL # 028-0020 ON
CRESCENT AVE.**



CITY COUNCIL

STAFF REPORT

Staff from the Hopewell Department of Development has drafted this report to assist City leadership with making informed decisions regarding land use cases in Hopewell.

I. APPLICANT: James R. Jones, PO Box 1402, Hopewell, VA 23860

II. EXECUTIVE SUMMARY

The applicant, James R. Jones, requests a Conditional Use Permit to construct a single-family dwelling on the non-conforming Parcel #028-0020 located on Crescent Ave. in the Crescent Hills Neighborhood. Staff recommends approval with conditions.

III. TENTATIVE SCHEDULE OF MEETINGS

BODY	EST. DATE	TYPE	RESULT
Planning Commission	April 4, 2024	Public Hearing	Pending
City Council	April 23, 2024	1 st Reading	No Action
City Council	May 14, 2024	2 nd Reading / PH	Pending

IV. IDENTIFICATION AND LOCATIONAL INFORMATION

Existing Zoning	R-1 – Residential Low Density
Requested Zoning	N/A
Acreage	0.203 acres / 8,850 sf
Legal Description	LOTS 14 TO 16 BLK 1 SUBDIVISION: CRESCENT HILLS
Election Ward	3
Future Land Use	Urban Residential
Strategic Plan Goal	Housing
Approval Method	City Council Resolution
Can Conditions be set?	Yes
Map Location	Parcel #028-0020

V. PUBLIC NOTIFICATION

PUBLIC HEARING	NOTIFICATION TYPE	DATE	DATE
Planning Commission	Progress-Index Ad	3/27/2024	4/3/2024
	Letter to Adj. Properties	3/28/2024	
City Council 1 st Read	Progress-Index Ad	N/A	N/A
	Letter to Adj. Properties	N/A	
City Council PH	Progress-Index Ad	TBD	TBD
	Letter to Adj. Properties	TBD	

VI. ROLE OF PLANNING COMMISSION AND CITY COUNCIL

Excerpted and paraphrased from *Handbook for Virginia Mayors & Council Members*

Within each zoning district some uses are permitted as a matter of right and others are only conditionally permitted. The theory behind the conditional use approach is that the particular use has a certain level of negative externality which, if properly managed, could allow the use to be established in the district. Absent proper management, conversely, the use is most likely unacceptable. The Conditional Use Permit process affords a case-by-case review. It is up to the local governing body to establish the conditions under which the Conditional Use Permit is to be approved; applicants/property owners are not required to agree to the conditions imposed for them to be valid and binding on the property. The question being considered is whether the proposed use in the proposed location can be conditioned in such a way as to prevent negative externalities from being imposed on adjacent and nearby properties. Possible negative externalities can comprise a long list that are often spelled out in the ordinance – smoke, dust, noise, trash, light, traffic, incompatible activity levels or hours of operation, likelihood of trespass on adjoining properties, stormwater/drainage runoff, inadequate public infrastructure, and many more.

Conditional Use Permits in Hopewell run with the land and not the owner.

VII. APPLICABLE CODE SECTIONS

1. [Article XVII, Non-Conforming Uses, Section F, Non-Conforming Lots of Record](#)
2. [Article XXI, Amendments, Section D, Conditional and Special Use Permits](#)

VIII. SUBJECT PROPERTY

The subject property, Parcel #028-0020, is an interior lot approximately in the center of the block on Crescent Ave. The property dimensions are 75 feet wide along Crescent Ave. by 118 feet deep for a total of 8,850 square feet. The R-1 Residential Low Density District sets the minimum lot width at 80 feet and the minimum lot size for a single-family dwelling at 12,000

square feet. The total square footage and the minimum width of this lot are less than the required minimum, making this parcel non-conforming to the R-1 District. The parcel also contains a steep ravine along the north western and western edges of the parcel.

IX. APPLICANT POSITION

The applicant proposes to construct a 1,659 square foot, one-story, single-family dwelling on the property. The proposed dwelling will be a Cottage-style home with a mixture of vinyl shake and stone veneer. The front door will be arched and the foundation will be brick. The applicant understands the storm water issues with the rear of the property and commits to correcting the issue with appropriate storm water management improvements. Please see the applicant's ADDENDUM to the CUP application for more information.

X. STAFF ANALYSIS

When considering a conditional use permit, one must consider the seven conditions outlined in Article XXI of the Zoning Ordinance (see attachment). The Planning Commission may also impose conditions that are suitable to ensure the character of the neighborhood and zoning district in which the use is locating will not be adversely affected. Conditions may also dictate the architectural style of a proposed structure to ensure it will not be at variance with either the exterior architectural appeal and/or the functional plan of the structures already constructed in the immediate neighborhood or the character of the applicable zoning district.

The required setbacks in the R-1 District are as follows:

- 25ft. – front yard.
- 10ft. – interior side yard; 20ft. – corner side yard.
- 25ft. – rear yard.

The parcel has a buildable area that is 55ft x 68ft (3,740sf) after applying the required setbacks. The steep ravine at the rear of the property further limits the buildable area.

Several lots in the neighborhood are of similar size and contain single-family dwellings.

XI. RELATIONSHIP TO THE COMPREHENSIVE PLAN

AGE OF HOUSING

Hopewell has seen lower levels of new development in recent decades when compared to other cities in the region and state, with a drastic slowdown beginning in the 1980s. For this reason, the city now has an aging stock of housing units, with nearly

80% of all units built in the 1970s or earlier (Hopewell Comprehensive Plan 2018, pg. 202).

THE FUTURE LAND USE PLAN

Stable areas are fully built-out and are not viewed as available strategic opportunity areas for future growth. This leaves infill development and redevelopment employing Traditional Neighborhood Design (TND) and Urban Development Area (UDA) principles as the land use form upon which City leaders must focus. It is important to distinguish between the two. Infill attempts to “seed” (or catalyze) a progressive movement to gradually upgrade the value and attractiveness of a given neighborhood or commercial area. Redevelopment focuses on larger properties or groups of properties that are substantially deteriorated or vacant, with potential economic value for the entire community.

Infill development and redevelopment projects can have substantial benefits for Hopewell. This will not occur without City guidance and planning initiatives. Communities that have pursued active infill and redevelopment programs have realized a strengthening of their real estate market by renewing housing stock and readapting sub-standard neighborhoods and sub-par commercial areas. *Hopewell Comprehensive Plan 2018, pg. 117).

XII. STAFF RECOMMENDATION

The parcel in question was the subject of a previous CUP request from a different applicant in 2022. City Councilors made the following comments relating to the 2022 CUP application:

1. The proposed single-family dwelling was not architecturally compatible with the surrounding dwellings or larger neighborhood.
2. The proposed single-family dwelling of 1,290 sf should be larger – at least 1,500sf.

Staff cites Article XXI, Section D, Item d(4), Approval Criteria, which states:

“As may be specified within each zoning district, uses permitted subject to conditional use review criteria shall be permitted only after review by the Planning Commission and approval by the City Council only if the applicant demonstrates that:

4. The proposed conditional use conforms to the character of the neighborhood within the same zoning district in which it is located. The proposal as submitted or modified shall have no more adverse effects on health, safety or comfort of persons living or working in or driving through the neighborhood, and shall be no more injurious to property or improvements in the neighborhood, than would any other use generally

permitted in the same district. In making such a determination, consideration shall be given to location, type, size, and height of buildings or structures, type and extent of landscaping and screening on the site, and whether the proposed use is consistent with any theme, action, policy or map of the Comprehensive Plan.”

The applicant was made aware of the issues with the previous CUP application for this property and has attempted to satisfactorily address those concerns. The proposed house is a Cottage-style dwelling with an appropriate mix of shake siding, stone veneer, and brick foundation. The size of the proposed dwelling is 1,659sf, larger than the average size of the neighborhood. For these reasons, Staff supports the approval of this application with the following conditions:

- a. The proposed dwelling as presented is to be constructed with stone veneer covering the full façade of the front door projection including the sides of the projection. The proposed vinyl shake shall cover all other front facades including all projection sides. Horizontal vinyl siding shall be installed on other building sides.
- b. Minimum 4” wide trim around all front façade windows and doors.
- c. A 3-paned window with 3-paned transom to the left of the front door as shown in the elevation submitted with the application.
- d. A driveway of concrete or asphalt will be installed in accordance with the City’s driveway policy.
- e. The dwelling will have a roof overhang/eaves on all sides.
- f. The applicant will install front foundation shrub plantings.
- g. The applicant will ensure a tree canopy of at least 20% lot coverage.
- h. The foundation will have a brick veneer on all sides.
- i. All other proffered features cited in the Addendum to the CUP Application submitted by the applicant and received by the City on March 11, 2024.

XIII. PLANNING COMMISSION RECOMMENDATION

The Hopewell Planning Commission voted 4-0 at the April 4, 2024 meeting to recommend approval of the CUP request with the following conditions:

- a. The proposed dwelling as presented is to be constructed with stone veneer covering the full façade of the front door projection including the sides of the projection. The proposed vinyl shake shall cover all other front facades including all projection sides. Horizontal vinyl siding shall be installed on other building sides.
- b. Minimum 4” wide trim around all front façade windows and doors.
- c. A 3-paned window with 3-paned transom to the left of the front door as shown in the elevation submitted with the application.
- d. A driveway of concrete or asphalt will be installed in accordance with the City’s driveway policy.
- e. The dwelling will have a minimum roof overhang of 12” on all sides.

- f. The applicant will install front foundation shrub plantings.
- g. The applicant will ensure a tree canopy of at least 20% lot coverage.
- h. The foundation will have a brick veneer on all sides.
- i. All other proffered features cited in the Addendum to the CUP Application submitted by the applicant and received by the City on March 11, 2024.
- j. The applicant will coordinate with the City's Stormwater Division on the armoring of the ravine and proper storm drainage.

APPENDIX A - MAPS

CITY LOCATIONAL MAP – Yellow Circle indicates general area

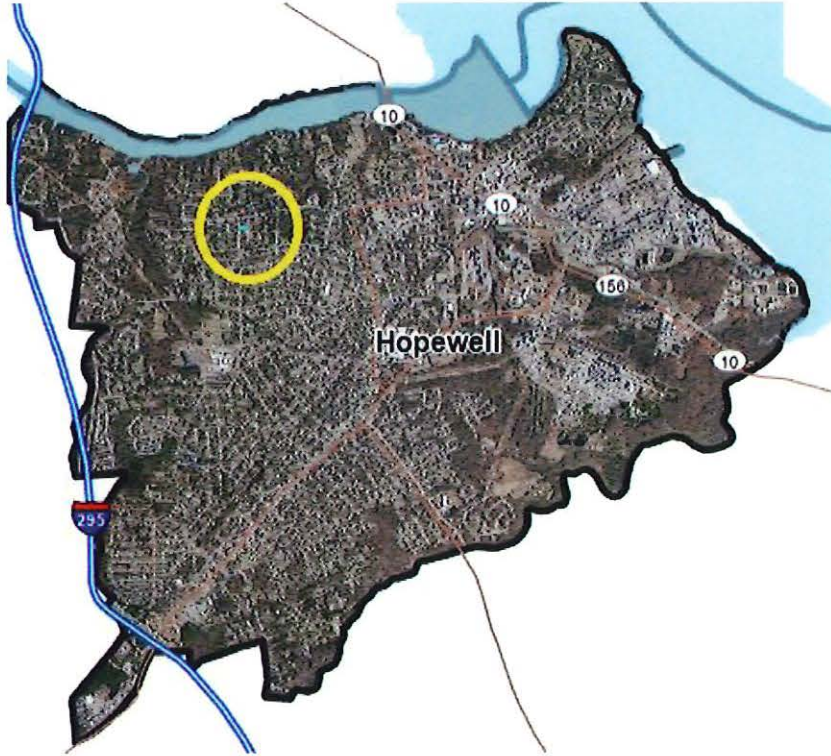

PROPERTY LOCATION – Red box indicates Parcel #028-0020

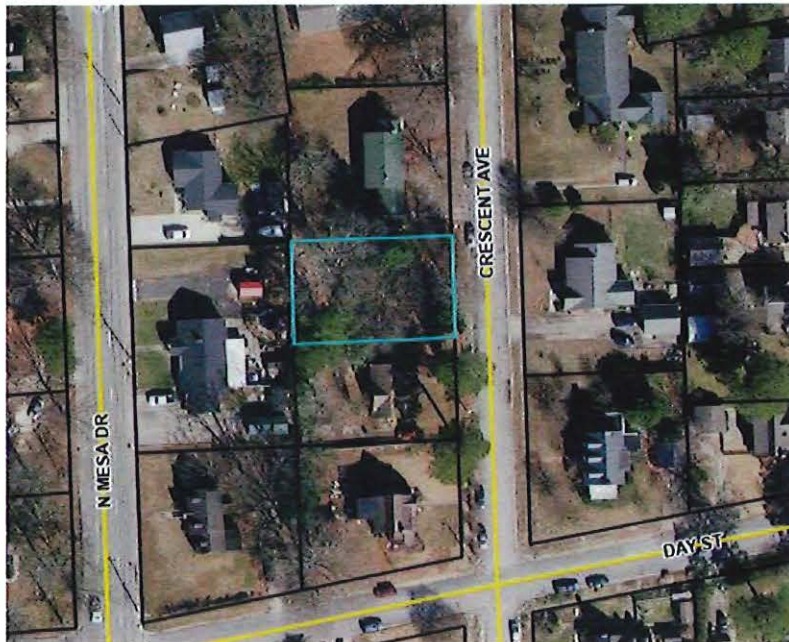

APPENDIX B – SURROUNDING AREA DATA

SURROUNDING PROPERTIES - PARCEL #028-0020

MOHAWK

	ADDRESS	STORIES	HOUSE SQ FT	WIDTH	DEPTH	LOT SQ FT	MATERIAL	YR BUILT	TYPE
1	3008 W BROADWAY	1	1,280	75	119	8,925	BRICK	1951	SF
2	3100 W BROADWAY	1	1,888	100	120	12,000	BRICK	1945	SF
3	200 MOHAWK	1	1,203	125	75	9,375	ALMNM	1952	SF
4	202 MOHAWK	1.5	1,362	75	125	9,375	VINYL	1954	SF
5	204 MOHAWK	1.5	2,033	100	125	12,500	BRICK	1951	SF
6	205 MOHAWK	1	1,991	100	125	12,500	BRICK	1953	SF
7	206 MOHAWK	1	1,496	86	123	10,578	ALMNM	1945	SF
8	207 MOHAWK	1	1,928	100	125	12,500	WOOD	1952	SF
9	3007 DAY	1	1,704	125	125	15,625	VINYL	1951	SF
	AVERAGE	1	1,654	69	118	7,823			
	#028-0020	1	1,659	75	118	9,430	VINYL/STONE		SF

SURROUNDING PROPERTIES - PARCEL #028-0020

MESA

	ADDRESS	STORIES	HOUSE SQ FT	WIDTH	DEPTH	LOT SQ FT	MATERIAL	YR BUILT	TYPE
1	200 N MESA	1.5	1,628	100	128	12,800+	VINYL	2013	SF
2	201 N MESA	1.5	1,764	112	118	13,216	MSNITE	1985	SF
3	205 N MESA	1	1,664	150	118	17,700	BRICK	1958	SF
4	206 N MESA	1	1,248	75	130	9,750	BRICK	1956	SF
5	207 N MESA	1	1,208	75	118	8,850	VINYL	1994	SF
6	208 N MESA	1	1,596	100	133	13,300	BRICK	1951	SF
7	2912 W BROADWAY	2	1,672	114	146	16,644	BRICK	1945	SF
8	3000 W BROADWAY	1.5	2,156	116	118	13,688	BRICK	1947	SF
	AVERAGE		1,617	105	126	13,243			
	#028-0020	1	1,659	75	118	9,430	VINYL/STONE		SF

SURROUNDING PROPERTIES - PARCEL #028-0020

CRESCENT

	ADDRESS	STORIES	HOUSE SQ FT	WIDTH	DEPTH	LOT SQ FT	MATERIAL	YR BUILT	TYPE
1	100 CRESCENT	2	1,502	108	118	12,744	BRICK	1941	SF
2	101 CRESCENT	1.5	2,038	120	118	14,160	WOOD	1941	SF
3	102 CRESCENT	1.5	2,268	75	118	8,850	BRICK	1951	SF
4	104 CRESCENT	1.5	1,661	90	118	10,620	BRICK	1920	SF
5	105 CRESCENT	2	1,441	162	118	19,116	BRICK	1929	SF
6	106 CRESCENT	2	2,290	97	118	11,446	ALMNM	1937	SF
7	107 CRESCENT	2	1,600	110	118	12,980	BRICK	1939	SF
8	108 CRESCENT	1.5	1,776	87	118	10,266	BRICK	1940	SF
9	109 CRESCENT	1.5	1,757	74	118	8,732	BRICK	1960	SF
	AVERAGE		1,815	103	118	12,102			
	#028-0020	1	1,659	75	118	9,430	VINYL/STONE		SF

R-3



CITY OF HOPEWELL CITY COUNCIL ACTION FORM

Strategic Operating Plan Vision Theme:

- Civic Engagement
- Culture & Recreation
- Economic Development
- Education
- Housing
- Safe & Healthy Environment
- None (Does not apply)

Order of Business:

- Consent Agenda
- Public Hearing
- Presentation-Boards/Commissions
- Unfinished Business
- Citizen/Councilor Request
- Regular Business
- Reports of Council Committees

Action:

- Approve and File
- Take Appropriate Action
- Receive & File (no motion required)
- Approve Ordinance 1st Reading
- Approve Ordinance 2nd Reading
- Set a Public Hearing
- Approve on Emergency Measure

COUNCIL AGENDA ITEM TITLE: Conditional Use Permit Requests to Construct two Single-Family Dwellings on two Non-Conforming Lots, Parcel #024-0310 and #024-0305 on Maryland Ave.

ISSUE: City ordinance requires CUP approval to construct a single-family dwelling on non-conforming lots. All setbacks must be met.

RECOMMENDATION: City Administration recommends no action at this time.

TIMING: City Council is requested on May 14, 2024

BACKGROUND: These applications were previously approved in 2022. See enclosed documents

ENCLOSED DOCUMENTS: CUP application, staff report, presentation

STAFF: Christopher Ward, Director of Development

FOR IN MEETING USE ONLY

MOTION: _____

Roll Call

SUMMARY:

- | Y | N | | Y | N | |
|--------------------------|--------------------------|-----------------------------------|--------------------------|--------------------------|--|
| <input type="checkbox"/> | <input type="checkbox"/> | Councilor Rita Joyner, Ward #1 | <input type="checkbox"/> | <input type="checkbox"/> | Councilor Janice Denton, Ward #5 |
| <input type="checkbox"/> | <input type="checkbox"/> | Councilor Michael Harris, Ward #2 | <input type="checkbox"/> | <input type="checkbox"/> | Councilor Brenda Pelham, Ward #6 |
| <input type="checkbox"/> | <input type="checkbox"/> | Mayor John B. Partin, Ward #3 | <input type="checkbox"/> | <input type="checkbox"/> | Councilor Dominic Holloway, Sr., Ward #7 |
| <input type="checkbox"/> | <input type="checkbox"/> | Vice Mayor Jasmine Gore, Ward #4 | | | |

SUMMARY:

Y N

- Councilor Rita Joyner, Ward #1
- Councilor Michael Harris, Ward #2
- Mayor John B. Partin, Ward #3
- Vice Mayor Jasmine Gore, Ward #4

Y N

- Councilor Janice Denton, Ward #5
- Councilor Brenda Pelham, Ward #6
- Councilor Dominic Holloway, Sr., Ward #7

CONDITIONAL USE PERMIT REQUEST

Single-Family Dwellings on Non-Conforming Lots

Parcels #024-0310 & #024-0305 - Maryland Ave.

CITY COUNCIL

April 23, 2024

CUP REQUEST: SFDs on Non-Conforming Parcels #024-0310 & #024-0305

- APPLICANT: David Edwards
- WARD: 2
- CURRENT ZONING: R-2 Res. Medium Density
- REQUEST: Approve CUP request
- PUBLIC NOTICE: Ads in Progress-Index, letters to adjacent property owners, sign placed at property

NOTE: CUPs were originally approved on March 22, 2022.



CUP REQUEST: SFDs on Non-Conforming Parcels #024-0310 & #024-0305

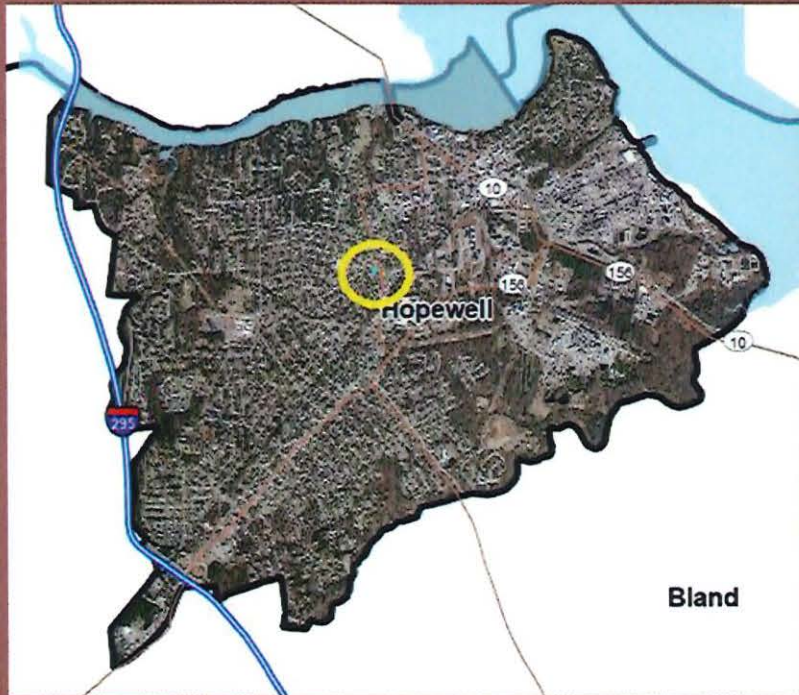

CUP REQUEST: SFDs on Non-Conforming Parcels #024-0310 & #024-0305

Minimum lot size in R-2 is 75 feet wide and 7,500sf.

Parcels #024-0310 & #024-0305 are 60 feet wide each and under 7,500sf.

Non-Conformity – Total lot size less than 12,000sf and lot width less than 70ft.



CUP REQUEST: SFDs on Non-Conforming Parcels #024-0310 & #024-0305

- 1-Story SF Dwellings
- 3 Bedroom; 2 Bath
- 1,300sf



CUP REQUEST: SFDs on Non-Conforming Parcels #024-0310 & #024-0305

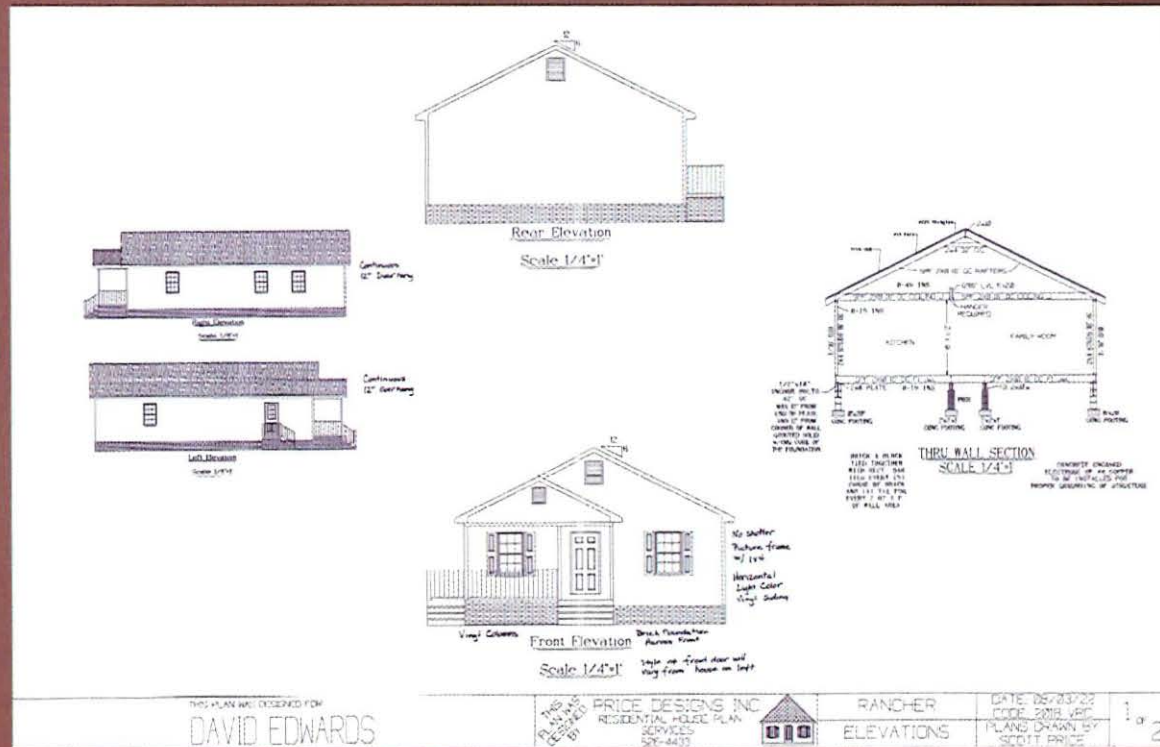

CUP REQUEST: SFDs on Non-Conforming Parcels #024-0310 & #024-0305

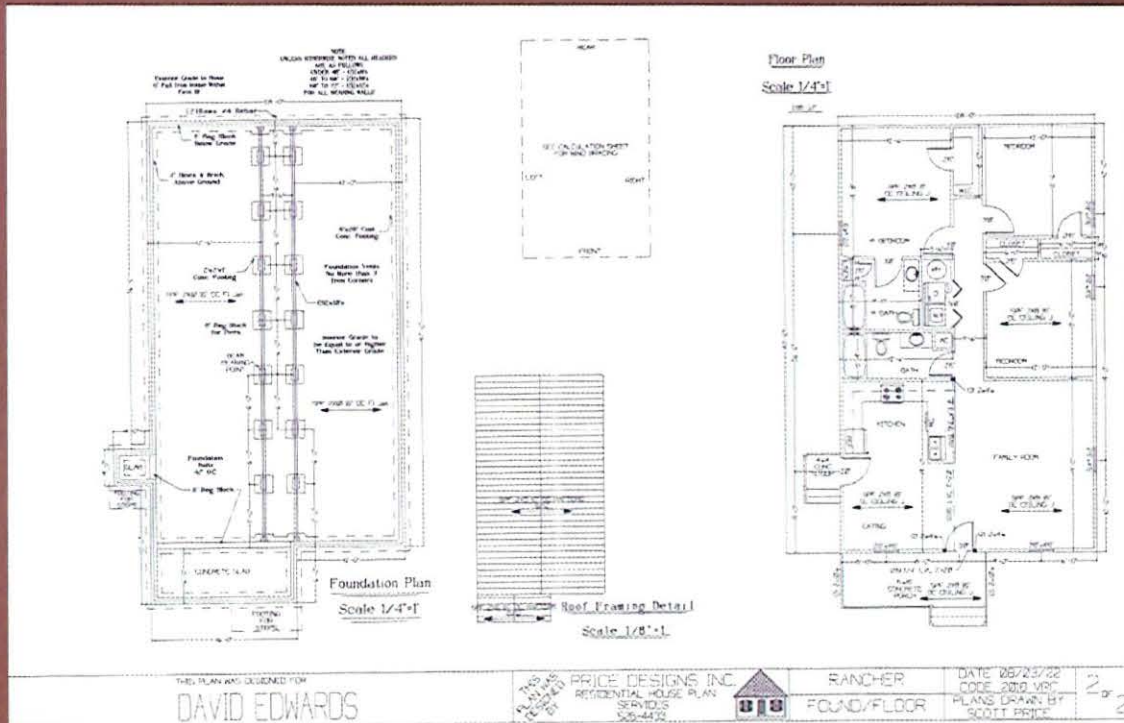

Staff Analysis

7 CUP Approval Criteria	✓
Comprehensive Plan	✓



- Proposed dwellings are compatible and complimentary with surrounding properties in size, scale, design, and materials.
- Average size of dwellings in the surrounding area is 1,123 sf.
- Proposed dwelling is 1,300sf.
- Proposed dwellings will vary in materials and color to avoid having the exact same house side-by-side.

Staff Recommendation

Staff recommends approval of the CUP requests with the following conditions:

1. Construct proposed dwellings as presented on house plans submitted 8/3/2022 including handwritten notations.
2. Install brick or stone veneer on all four sides of foundation.
3. Construct dwellings with roof overhand/eaves on all sides.
4. Install driveway of concrete or asphalt according to City's policy.
5. Install front foundation shrub plantings.
6. Ensure tree canopy of 20%.

Planning Commission Recommendation

Public
Hearing
April 4,
2024

Planning Commission recommends approval (4-0) of the CUP requests with the following conditions:

1. Construct proposed dwellings as presented on house plans submitted 8/3/2022 including handwritten notations.
2. Install brick or stone veneer on all four sides of foundation.
3. Construct dwellings with roof overhang/eaves on all sides.
4. Install driveway of concrete or asphalt according to City's policy.
5. Install front foundation shrub plantings.
6. Ensure tree canopy coverage of at least 20%.

Recommendation for City Council

Take action after the public hearing tentatively scheduled for

May 14, 2024.

CUP REQUEST: SFDs on Non-Conforming Parcels #024-0310 & #024-0305

Questions?



The City
of
Hopewell, Virginia

300 N. Main Street · Department of Development · (804) 541-2220 · Fax: (804) 541-2318

CONDITIONAL USE PERMIT APPLICATION

APPLICATION FEE: \$300

APPLICATION #

APPLICANT: DAVID EDWARDS CUSTOM BUILDER INC
ADDRESS: P.O. Box 669
Prince George, VA 23875
PHONE #: 804-691-6092 FAX #: _____
EMAIL ADDRESS: debbie.edwards@jamescrest.net

INTEREST IN PROPERTY: _____ OWNER OR AGENT
IF CONTRACT PURCHASER, PROVIDE A COPY OF THE CONTRACT OR A LETTER
OF THE PROPERTY OWNER'S CONSENT TO MAKE APPLICATION.

OWNER: Christopher & Kelly Gill
ADDRESS: P.O. Box 669
Prince George, Va 23875
PHONE #: 804-691-6092 FAX #: _____

PROPERTY ADDRESS / LOCATION:

Maryland Ave Lots 12 & 13 Block 4 Buren S/O

PARCEL #: 0240310 ACREAGE: _____ ZONING: R-2

*** IF REQUIRED BY ARTICLE 16 OF THE ZONING ORDINANCE, ***
A SITE PLAN MUST ACCOMPANY THIS APPLICATION

ATTACH A SCALED DRAWING OR PLAT OF THE PROPERTY SHOWING:

1. FLOOR PLANS OF THE PROPOSED BUILDINGS. _____
2. THE PROPOSED DEVELOPMENT WITH FRONT, SIDE, AND REAR ELEVATIONS. _____

App# 20240393

THIS REQUEST FOR A CONDITIONAL USE PERMIT IS FILED UNDER SECTION _____ OF THE ZONING ORDINANCE.

PRESENT USE OF PROPERTY:

Open Land - cleared lot

THE CONDITIONAL USE PERMIT WILL ALLOW:

Construction of a 3 bedroom home 1316 sq ft

PLEASE DEMONSTRATE THAT THE PROPOSAL AS SUBMITTED OR MODIFIED WILL NOT AFFECT ADVERSELY THE HEALTH, SAFETY, OR WELFARE OF PERSONS RESIDING OR WORKING IN THE NEIGHBORHOOD OF THE PROPOSED USE.

Proposed construction will improve the neighborhood & eliminate unsightly empty lot where others congregate without permission of owners

PLEASE DEMONSTRATE THAT THE PROPOSAL WILL NOT BE DETRIMENTAL TO PUBLIC WELFARE OR INJURIOUS TO THE PROPERTY OR IMPROVEMENTS IN THE NEIGHBORHOOD.

Proposed construction will not create adverse parking or additional traffic

PLEASE DEMONSTRATE HOW THE PROPOSAL AS SUBMITTED OR MODIFIED WILL CONFORM TO THE COMPREHENSIVE PLAN AND THE PURPOSES AND THE EXPRESSED INTENT OF THE ZONING ORDINANCE.

Proposed construction is within the appropriate zoning of R-2

AS OWNER OF THIS PROPERTY OR THE AUTHORIZED AGENT THEREFOR, I HEREBY CERTIFY THAT THIS APPLICATION AND ALL ACCOMPANYING DOCUMENTS ARE COMPLETE AND ACCURATE TO THE BEST OF MY KNOWLEDGE.

Deborah H. Edwards, VP
APPLICANT SIGNATURE

3-5-24
DATE

DEBORAH H. EDWARDS VP
APPLICANT PRINTED NAME

OFFICE USE ONLY

DATE RECEIVED _____ DATE OF ACTION _____

APPROVED _____ DENIED

APPROVED WITH THE FOLLOWING CONDITIONS:



Department of Development
City of Hopewell, Virginia
Residential Lot Plans

Official Use Only	
Application Number:	_____
Permit Number:	_____

Affidavit of Responsibility

Application for the following:

Property Address/Parcel: 0240310

Lot: 12 & 13 Block: 4 Subdivision: Buren

I, DEBORAH H. EDWARDS, VP, by filing this affidavit certify that I am the owner or authorized agent of David Edwards Custom Builders, Inc; and further, certify that I have enclosed the Residential Lot Plan to be included as part of the Building Permit.

Furthermore, I certify that the lot grading of the aforementioned parcel will be consistent with the submitted plan. If within 12 months after a CO has been issued the City of Hopewell determines that the drainage configuration does not function properly, I will assume full responsibility to make corrections in order that the drainage will function as intended and approved by the City of Hopewell.

APPLICANT NAME (PRINT):

DEBORAH H EDWARDS, VP

SIGNATURE: Deborah H Edwards VP

DATE: 3-6-24

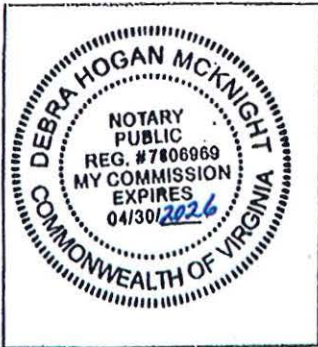

CITY/COUNTY OF Hopewell
COMMONWEALTH OF VIRGINIA

THE FOREGOING INSTRUMENT WAS ACKNOWLEDGED BEFORE ME

THIS 6th DAY OF March, 2020 BY
NOTARY PUBLIC: [Signature]

NOTARY PUBLIC REGISTRATION NUMBER: 7806969

MY COMMISSION EXPIRES: 30 April, 2026

Proposed Dwelling for C.V.D. apps.





The City
of
Hopewell, Virginia

300 N. Main Street • Department of Development • (804) 541-2220 • Fax: (804) 541-2318

CONDITIONAL USE PERMIT APPLICATION

APPLICATION FEE: \$300

APPLICATION #

APPLICANT: DAVID Edwards Custom Builder, Inc.
ADDRESS: P.O. Box 669
Prince George, VA 23875
PHONE #: 804-691-6092 FAX #: _____
EMAIL ADDRESS: debbie.edwards@jamescrest.net

INTEREST IN PROPERTY: OWNER OR _____ AGENT
IF CONTRACT PURCHASER, PROVIDE A COPY OF THE CONTRACT OR A LETTER
OF THE PROPERTY OWNER'S CONSENT TO MAKE APPLICATION.

OWNER: DAVID Edwards Custom Builder, Inc.
ADDRESS: P.O. Box 669
Prince George, Va 23875
PHONE #: 804-691-6092 FAX #: _____

PROPERTY ADDRESS / LOCATION:

Maryland Ave Lots 10 & 11 Block 4 Buren s/d
PARCEL #: 0240305 ACREAGE: _____ ZONING: R-2

*** IF REQUIRED BY ARTICLE 16 OF THE ZONING ORDINANCE, ***
A SITE PLAN MUST ACCOMPANY THIS APPLICATION

ATTACH A SCALED DRAWING OR PLAT OF THE PROPERTY SHOWING:

1. FLOOR PLANS OF THE PROPOSED BUILDINGS. _____
2. THE PROPOSED DEVELOPMENT WITH FRONT, SIDE, AND REAR ELEVATIONS. _____

App# 20240392

THIS REQUEST FOR A CONDITIONAL USE PERMIT IS FILED UNDER SECTION _____ OF THE ZONING ORDINANCE.

PRESENT USE OF PROPERTY:

open land - cleared lot

THE CONDITIONAL USE PERMIT WILL ALLOW:

Construction of a 3 bedroom house

PLEASE DEMONSTRATE THAT THE PROPOSAL AS SUBMITTED OR MODIFIED WILL NOT AFFECT ADVERSELY THE HEALTH, SAFETY, OR WELFARE OF PERSONS RESIDING OR WORKING IN THE NEIGHBORHOOD OF THE PROPOSED USE.

Proposed dwelling will improve the neighborhood & eliminate unsightly open land where others congregate without permission of owner

PLEASE DEMONSTRATE THAT THE PROPOSAL WILL NOT BE DETRIMENTAL TO PUBLIC WELFARE OR INJURIOUS TO THE PROPERTY OR IMPROVEMENTS IN THE NEIGHBORHOOD.

Proposed dwelling will not create adverse parking or additional traffic

PLEASE DEMONSTRATE HOW THE PROPOSAL AS SUBMITTED OR MODIFIED WILL CONFORM TO THE COMPREHENSIVE PLAN AND THE PURPOSES AND THE EXPRESSED INTENT OF THE ZONING ORDINANCE.

Proposed dwelling is within the appropriate zoning of R-2

AS OWNER OF THIS PROPERTY OR THE AUTHORIZED AGENT THEREFOR, I HEREBY CERTIFY THAT THIS APPLICATION AND ALL ACCOMPANYING DOCUMENTS ARE COMPLETE AND ACCURATE TO THE BEST OF MY KNOWLEDGE

Deborah H. Edwards VP
APPLICANT SIGNATURE

3-5-24
DATE

DEBORAH H. EDWARDS
APPLICANT PRINTED NAME

OFFICE USE ONLY

DATE RECEIVED _____ DATE OF ACTION _____

APPROVED _____ DENIED

APPROVED WITH THE FOLLOWING CONDITIONS:



Department of Development
City of Hopewell, Virginia
Residential Lot Plans

Official Use Only
Application Number: _____
Permit Number: _____

Affidavit of Responsibility

Application for the following:

Property Address/Parcel: 0240305

Lot: 10&11 Block: 4 Subdivision: Bures

I, DEBORAH H. EDWARDS, VP, by filing this affidavit certify that I am the owner or authorized agent of David Edwards Custom Builders, Inc. and further, certify that I have enclosed the Residential Lot Plan to be included as part of the Building Permit.

Furthermore, I certify that the lot grading of the aforementioned parcel will be consistent with the submitted plan. If within 12 months after a CO has been issued the City of Hopewell determines that the drainage configuration does not function properly, I will assume full responsibility to make corrections in order that the drainage will function as intended and approved by the City of Hopewell.

APPLICANT NAME (PRINT):

DEBORAH H. EDWARDS VP

SIGNATURE: Deborah H. Edwards, VP

DATE: 3-8-23

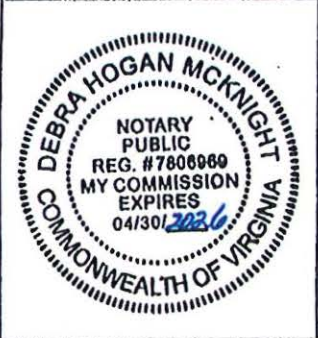

CITY/COUNTY OF Hopewell
COMMONWEALTH OF VIRGINIA
THE FOREGOING INSTRUMENT WAS ACKNOWLEDGED BEFORE ME
THIS 6th DAY OF March, 2020 BY
NOTARY PUBLIC: [Signature]
NOTARY PUBLIC REGISTRATION NUMBER: 7806969
MY COMMISSION EXPIRES: 30 April, 2026

Proposed Dwelling for C.V.P. apps.





**REQUEST FOR CONDITIONAL USE PERMITS
TO CONSTRUCT TWO SINGLE-FAMILY DWELLINGS
ON TWO NON-CONFORMING LOTS, PARCEL #
024-0305 AND PARCEL #024-0310 ON
MARYLAND AVE.**



CITY COUNCIL

STAFF REPORT

Staff from the Hopewell Department of Development has drafted this report to assist City leadership with making informed decisions regarding land use cases in Hopewell.

I. EXECUTIVE SUMMARY

The applicant, David Edwards Custom Builder, Inc., requests Conditional Use Permits to construct two single-family dwellings on two non-conforming lots, Parcels #024-0305 and Parcel #024-0310, located on Maryland Ave. in the Buren neighborhood. Conditional Use Permits for these parcels were previously approved on March 22, 2022 but the applicant did not complete construction within one year, as required by the Hopewell Zoning Ordinance. Staff recommends re-approval with conditions.

II. TENTATIVE SCHEDULE OF MEETINGS

BODY	DATE	TYPE	RESULT
Planning Commission	April 4, 2024	Public Hearing	Pending
City Council	April 23, 2024	1 st Reading	No Action
City Council	May 14, 2024	2 nd Reading / PH	Pending

III. IDENTIFICATION AND LOCATIONAL INFORMATION

Existing Zoning	R-2 – Residential Medium Density
Requested Zoning	N/A
Acreage: 024-0305 & 024-0310	0.172 ac/7,492sf & 0.167 ac/7,275sf
Legal Description	LOTS 10-11 and LOTS 12-13 BLK 4 SUBDIVISION: BUREN
Election Ward	2
Future Land Use	Urban Residential
Strategic Plan Goal	Housing
Approval Method	City Council Resolution

Can Conditions be set?	Yes
Map Location	Parcel #024-0305 & #024-0310

IV. PUBLIC NOTIFICATION

PUBLIC HEARING	NOTIFICATION TYPE	DATE	DATE
Planning Commission	Progress-Index Ad	3/27/2024	4/3/2024
	Letter to Adj. Properties	3/28/2024	
City Council	Progress-Index Ad	N/A	N/A
	Letter to Adj. Properties	N/A	
City Council	Progress-Index Ad	TBD	TBD
	Letter to Adj. Properties	TBD	

V. ROLE OF PLANNING COMMISSION AND CITY COUNCIL

Excerpted and paraphrased from *Handbook for Virginia Mayors & Council Members*

Within each zoning district some uses are permitted as a matter of right and others are only conditionally permitted. The theory behind the conditional use approach is that the particular use has a certain level of negative externality which, if properly managed, could allow the use to be established in the district. Absent proper management, conversely, the use is most likely unacceptable. The Conditional Use Permit process affords a case-by-case review. It is up to the local governing body to establish the conditions under which the Conditional Use Permit is to be approved; applicants/property owners are not required to agree to the conditions imposed for them to be valid and binding on the property. The question being considered is whether the proposed use in the proposed location can be conditioned in such a way as to prevent negative externalities from being imposed on adjacent and nearby properties. Possible negative externalities can comprise a long list that are often spelled out in the ordinance – smoke, dust, noise, trash, light, traffic, incompatible activity levels or hours of operation, likelihood of trespass on adjoining properties, stormwater/drainage runoff, inadequate public infrastructure, and many more.

Conditional Use Permits in Hopewell run with the land and not the owner.

VI. APPLICABLE CODE SECTIONS

1. [Article XVII, Non-Conforming Uses, Section F, Non-Conforming Lots of Record](#)
2. [Article XXI, Amendments, Section D, Conditional and Special Use Permits](#)

VII. SUBJECT PROPERTY

The subject properties, Parcel #024-0305 and #024-0310, are adjoining interior lots approximately in the center of the block on Maryland Ave. The property dimensions are 60

feet wide along Maryland. by approximately 120 feet deep for a total of approximately 3,600-3,700 square feet. The parcels are not perfect rectangles. The R-2 Residential Medium Density District sets the minimum lot width at 75 feet and the minimum lot size for a single-family dwelling at 7,500 square feet. The total square footage and the minimum width of these lots are less than the required minimum, making these parcel non-conforming to the R-2 District.

VIII. APPLICANT POSITION

The applicant proposes to construct two 1,300sf, one-story, single-family dwellings – one on each of the adjoining properties. The proposed dwellings will be Rancher-style homes with a mixture of vinyl siding and masonry veneer (brick, stone). The proposed dwellings will be of the same architecture and design but will utilize differing and unique materials to differentiate the two homes.

IX. STAFF ANALYSIS

When considering a conditional use permit, one must consider the seven conditions outlined in Article XXI of the Zoning Ordinance (see attachment). The Planning Commission may also impose conditions that are suitable to ensure the character of the neighborhood and zoning district in which the use is locating will not be adversely affected. Conditions may also dictate the architectural style of a proposed structure to ensure it will not be at variance with either the exterior architectural appeal and/or the functional plan of the structures already constructed in the immediate neighborhood or the character of the applicable zoning district.

The required setbacks in the R-2 District are as follows:

- 25ft. – front yard.
- 10ft. – interior side yard; 15ft. – corner side yard.
- 25ft. – rear yard.

The parcel has a buildable area that is approximately 40ft x 70ft (2,800sf) after applying the required setbacks.

Several lots in the neighborhood are of similar size and contain single-family dwellings.

X. RELATIONSHIP TO THE COMPREHENSIVE PLAN

AGE OF HOUSING

Hopewell has seen lower levels of new development in recent decades when compared to other cities in the region and state, with a drastic slowdown beginning in the 1980s. For this reason, the city now has an aging stock of housing units, with nearly

80% of all units built in the 1970s or earlier (Hopewell Comprehensive Plan 2018, pg. 202).

THE FUTURE LAND USE PLAN

Stable areas are fully built-out and are not viewed as available strategic opportunity areas for future growth. This leaves infill development and redevelopment employing Traditional Neighborhood Design (TND) and Urban Development Area (UDA) principles as the land use form upon which City leaders must focus. It is important to distinguish between the two. Infill attempts to “seed” (or catalyze) a progressive movement to gradually upgrade the value and attractiveness of a given neighborhood or commercial area. Redevelopment focuses on larger properties or groups of properties that are substantially deteriorated or vacant, with potential economic value for the entire community.

Infill development and redevelopment projects can have substantial benefits for Hopewell. This will not occur without City guidance and planning initiatives. Communities that have pursued active infill and redevelopment programs have realized a strengthening of their real estate market by renewing housing stock and readapting sub-standard neighborhoods and sub-par commercial areas. *Hopewell Comprehensive Plan 2018, pg. 117).

XI. STAFF RECOMMENDATION

Conditional Use Permits were previously approved for these parcels with the same proposed dwellings. Staff at that time supported the applications and continues to support the applications for the following reasons:

1. The proposed houses are larger than the average house size in the neighborhood.
2. Although of the same general architectural style, the applicant has proposed to differentiate the two homes by using different façade materials.
3. The proposed architectural style is compatible with the rest of the neighborhood.

Staff cites Article XXI, Section D, Item d(4), Approval Criteria, which states:

“As may be specified within each zoning district, uses permitted subject to conditional use review criteria shall be permitted only after review by the Planning Commission and approval by the City Council only if the applicant demonstrates that:

4. The proposed conditional use conforms to the character of the neighborhood within the same zoning district in which it is located. The proposal as submitted or modified shall have no more adverse effects on health, safety or comfort of persons living or working in or driving through the neighborhood, and shall be no more injurious to

property or improvements in the neighborhood, than would any other use generally permitted in the same district. In making such a determination, consideration shall be given to location, type, size, and height of buildings or structures, type and extent of landscaping and screening on the site, and whether the proposed use is consistent with any theme, action, policy or map of the Comprehensive Plan.”

Staff supports the approval of this application with the following conditions:

- a. The proposed dwellings are to be constructed as presented (handwritten notations included) in the house plans submitted with the application dated 8/3/2022
- b. The foundation will have brick or stone veneer on all sides.
- c. The house will be constructed with roof overhang/eaves on all sides.
- d. A driveway of concrete or asphalt will be installed in accordance with the City’s driveway policy.
- e. The applicant will install front foundation shrub plantings.
- f. The applicant will ensure a tree canopy of at least 20% lot coverage.

XII. PLANNING COMMISSION RECOMMENDATION

The Hopewell Planning Commission voted 4-0 at the April 4, 2024 meeting to recommend approval of the CUP request with the following conditions:

- a. The proposed dwellings are to be constructed as presented (handwritten notations included) in the house plans submitted with the application dated 8/3/2022
- b. The foundation will have brick or stone veneer on all sides.
- c. The house will be constructed with roof overhang/eaves on all sides.
- d. A driveway of concrete or asphalt will be installed in accordance with the City’s driveway policy.
- e. The applicant will install front foundation shrub plantings.
- f. The applicant will ensure a tree canopy of at least 20% lot coverage.

APPENDIX A - MAPS

CITY LOCATIONAL MAP – Yellow Circle indicates general area

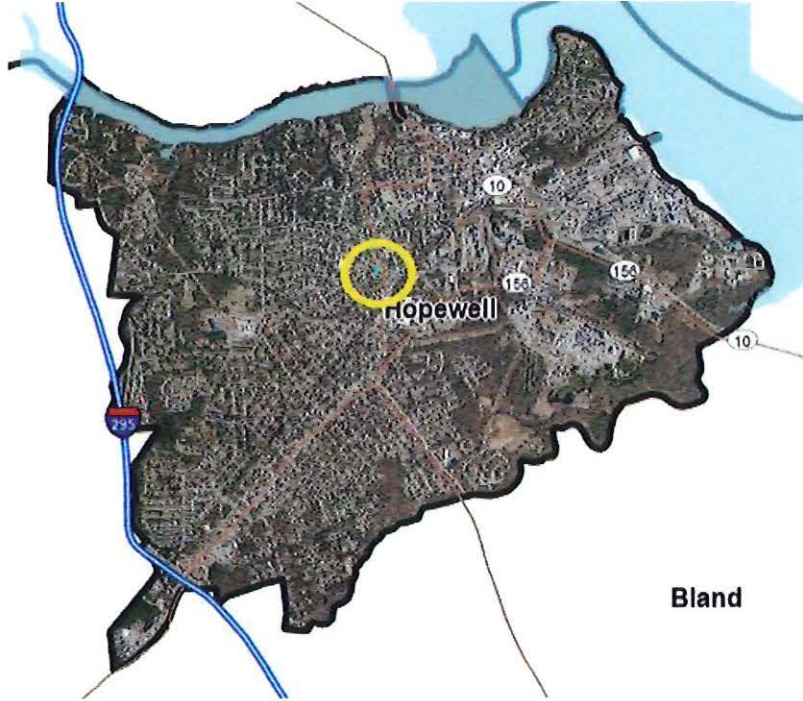

PROPERTY LOCATION – Red & blue boxes indicate subject parcels



APPENDIX B – SURROUNDING AREA DATA

SURROUNDING PROPERTIES - PARCEL #028-0020
MARYLAND

	ADDRESS	STORIES	HOUSE SQ FT	WIDTH	DEPTH	LOT SQ FT	MATERIAL	YR BUILT	TYPE
	310								
1	MARYLAND	1	936	30	75	2,100	ASBSTS	1920	SF
	314								
2	MARYLAND	1	1,032	60	88	5,280	MASNITE	1920	SF
	318								
3	MARYLAND	1	984	30	102	3,060	VINYL	1920	SF
	328								
4	MARYLAND	1.5	1,704	30	79	2,370	BRICK	1954	SF
	330								
5	MARYLAND	1	864	30	55	1,650	BRICK	1920	SF
	1505								
6	LYNCHBURG	1	1,296	60	85	5,100	BRICK	1963	SF
	1507								
7	LYNCHBURG	1	1,288	30	102	3,060	VINYL	2007	SF
	1511								
8	LYNCHBURG	1	1,248	63	113	7,119	VINYL	2005	SF
9	335 S 17 TH	1	1,191	65	85	5,525	VINYL	2004	SF
10	319 S 17 TH	1	943	30	109	3,270	MASNITE	1920	SF
11	315 S 17 TH	1	736	30	90	2,700	VINYL	1920	SF
12	311 S 17 TH	1	748	76	77	5,852	ASBSTS	1955	SF
13	309 S 17 TH	1	1,278	50	110	5,500	VINYL	2003	SF
14	307 S 17 TH	1.5	1,473			7,841	VINYL	2003	SF
	AVERAGE	1	1,123	45	90	4,316			
	#024-0305								
	#024-0310	1	1,300	60	120	7,200+	VINYL/STONE		SF

R-4



CITY OF HOPEWELL CITY COUNCIL ACTION FORM

Strategic Operating Plan Vision Theme:

- Civic Engagement
- Culture & Recreation
- Economic Development
- Education
- Housing
- Safe & Healthy Environment
- None (Does not apply)

Order of Business:

- Consent Agenda
- Public Hearing
- Presentation-Boards/Commissions
- Unfinished Business
- Citizen/Councilor Request
- Regular Business
- Reports of Council Committees

Action:

- Approve and File
- Take Appropriate Action
- Receive & File (no motion required)
- Approve Ordinance 1st Reading
- Approve Ordinance 2nd Reading
- Set a Public Hearing
- Approve on Emergency Measure

COUNCIL AGENDA ITEM TITLE: Amendment of FY24 School Board Operating & Cafeteria Fund Budgets

ISSUE: Supplemental appropriation amending the FY24 Hopewell Public Schools operating budget by a total of \$6,354,804 in additional federal, state, and other grants increasing the total operating budget to \$74,556,462.

Also, a supplemental appropriation amending the FY24 Hopewell Public Schools cafeteria fund budget by a total of \$478,581 in additional other funds, increasing the total cafeteria fund budget to \$3,550,807.

RECOMMENDATION: Staff recommends that City Council approve the resolution to amend the FY24 Hopewell Public Schools supplemental budget appropriation, as presented.

TIMING: A public hearing will need to be conducted.

BACKGROUND: The Hopewell Public School (HPS) Division’s FY24 budget was approved by City Council on June 13, 2023. Hopewell Public Schools have received supplemental appropriations of state and federal funding along with grant funds in the total of \$6,833,385. HPS received a school security officer grant, a year round schools grant, a grant from VCU, a school security equipment grant, a Stronger Connections grant, a grant from the Department of Behavioral Health and Developmental Services, as well as additional funds from the state of VA. HPS also is correcting it’s budget for carryover amounts of federal and state grants. These funds will increase the total HPS Operating Fund to \$74,556,462 and the Cafeteria Fund to \$3,550,807.

SUMMARY:

- | | | | | |
|--------------------------|--------------------------|-----------------------------------|--------------------------|--|
| Y | N | | Y | N |
| <input type="checkbox"/> | <input type="checkbox"/> | Councilor Rita Joyner, Ward #1 | <input type="checkbox"/> | <input type="checkbox"/> |
| <input type="checkbox"/> | <input type="checkbox"/> | Councilor Michael Harris, Ward #2 | <input type="checkbox"/> | <input type="checkbox"/> |
| <input type="checkbox"/> | <input type="checkbox"/> | Mayor John B. Partin, Ward #3 | <input type="checkbox"/> | <input type="checkbox"/> |
| <input type="checkbox"/> | <input type="checkbox"/> | Vice Mayor Jasmine Gore, Ward #4 | <input type="checkbox"/> | <input type="checkbox"/> |
| | | | <input type="checkbox"/> | <input type="checkbox"/> |
| | | | | Councilor Janice Denton, Ward #5 |
| | | | | Councilor Brenda Pelham, Ward #6 |
| | | | | Councilor Dominic Holloway, Sr., Ward #7 |

ENCLOSED DOCUMENTS:

- **Budget Amendment Resolution – Supplemental Appropriation #1, #2, #3, & #4**

STAFF: Dr. Melody D. Hackney, Superintendent of Schools

Janel F. English, Director of Finance, Hopewell Public Schools

FOR IN MEETING USE ONLY

MOTION: _____

Roll Call

SUMMARY:

Y N

- Councilor Rita Joyner, Ward #1
- Councilor Michael Harris, Ward #2
- Mayor John B. Partin, Ward #3
- Vice Mayor Jasmine Gore, Ward #4

Y N

- Councilor Janice Denton, Ward #5
- Councilor Brenda Pelham, Ward #6
- Councilor Dominic Holloway, Sr., Ward #7

FY24 Proposed School Budget

	Original Budget	Changes	Adjusted Budget
School Operating Fund - 014			
Estimated Revenues			
State Sources	37,787,530	5,745,145	43,532,675
Federal Sources	11,580,744	1,045,924	12,626,668
Other Revenues	4,337,936	479,184	4,817,120
Transfer from General Fund	14,495,448	(915,448)	13,580,000
Total Revenues	<u>68,201,658</u>	<u>6,354,804</u>	<u>74,556,462</u>
Appropriations			
Non-Categorical	<u>68,201,658</u>	<u>6,354,804</u>	<u>74,556,462</u>
Total School Operating Fund	<u>68,201,658</u>	<u>6,354,804</u>	<u>74,556,462</u>
School Textbook Fund - 056			
Estimated Revenues			
State Sources	<u>1,529,794</u>	-	<u>1,529,794</u>
Total Revenues	<u>1,529,794</u>	-	<u>1,529,794</u>
Appropriations			
Textbook Purchases	<u>1,529,794</u>	-	<u>1,529,794</u>
Total School Textbook Fund	<u>1,529,794</u>	-	<u>1,529,794</u>
School Cafeteria Fund - 057			
Estimated Revenues			
States Sources	33,958	-	33,958
Federal Sources	2,400,000	-	2,400,000
Other Sources	638,268	478,581	1,116,849
Total Revenues	<u>3,072,226</u>	<u>478,581</u>	<u>3,550,807</u>
Appropriations			
Operating Expenses	<u>3,072,226</u>	<u>478,581</u>	<u>3,550,807</u>
Total School Cafeteria Fund	<u>3,072,226</u>	<u>478,581</u>	<u>3,550,807</u>
School Building/Bus Replacement Fund - 063			
Estimated Revenues			
Other Sources	<u>47,180</u>	-	<u>47,180</u>
Total Revenues	<u>47,180</u>	-	<u>47,180</u>
Appropriations			
Appropriations	<u>47,180</u>	-	<u>47,180</u>
Total School Building/Bus Repl Fund	<u>47,180</u>	-	<u>47,180</u>
Total Budget Request	<u>72,850,858</u>	<u>6,833,385</u>	<u>79,684,243</u>

Hopewell City School Board FY24 Budget

Board Resolution Number	Original Budget Approved 5/11/2023 23-05-G2	Amended Budget Approved 6/7/2023 23-06-G19	Supplemental Appropriation FY24 #1 Approved 11/6/2023 23-11-G3	Supplemental Appropriation FY24 #2 Approved 11/6/2023 23-11-G4	Supplemental Appropriation FY24 #3 Approved 12/11/2023 23-12-G2	Adjustment to Correct Budget to Match City Approved 1/11/2024 24-01-G2	Supplemental Appropriation FY24 #4 Approved 2/8/2024 24-02-G2	Total of Supplemental Appropriations That Need City Approval	FY24 REVISED SCHOOL BOARD BUDGET
Fund	Approved by City:								
14 Operating Fund	\$68,701,658	\$68,201,658	\$2,822,200	\$3,494,837	\$558,975	-\$915,448	\$394,240	\$6,354,804	\$74,556,462
63 Building/Bus Replacement Fund	\$47,180	\$47,180	\$0	\$0	\$0	\$0	\$0	\$0	\$47,180
56 Textbook Fund	\$1,529,794	\$1,529,794	\$0	\$0	\$0	\$0	\$0	\$0	\$1,529,794
57 School Food Fund	\$3,072,226	\$3,072,226	\$478,581	\$0	\$0	\$0	\$0	\$478,581	\$3,550,807
Total Budget	\$73,350,858	\$72,850,858	\$3,300,781	\$3,494,837	\$558,975	-\$915,448	\$394,240	\$6,833,385	\$79,684,243

	Grant Carryovers/SSO	School Security Equipment Grant/Title IVA Stronger Connections Grant	Department of Behavioral Health and Developmental Services (DBHDS)
Cut Request by \$500,000	Grant/Year Round Schools Grant/VCU Grant/Food Services Actual Beginning Balance	Additional State Funding	To Match City Appropriation

Approval of Supplemental Appropriation

FY24 #1

23-11-G3

RESOLVED, upon the recommendation of the Superintendent of Schools, that a supplemental appropriation to the Operating Fund, in the amount of \$2,822,200 and to the Cafeteria Fund, in the amount of \$478,581 for federal and state grants be and is hereby approved for FY24. The grants below are as follows:

Federal Grant Carryovers: \$703,186

School Security Officer Grant: \$39,890

Year Round Schools Grant: \$1,600,000

VCU Grant: \$50,000

Operating Fund Beginning Balance Correction: \$429,184

Correction to State Funds: (\$60.00)

Cafeteria Fund Beginning Balance Correction: \$478,581

Approval of Supplemental Appropriation

FY24 #2

23-11-G4

RESOLVED, upon the recommendation of the Superintendent of Schools, that a supplemental appropriation to the Operating Fund, in the amount of \$3,494,837 for additional state funding be and is approved to be added to FY24, once the Virginia Department of Education approves Hopewell's All-In Virginia Plan.



General Resolutions for December 11, 2023

Warrants
Review of Bills
November
23-12-G1

RESOLVED, upon the recommendation of the Superintendent of Schools, that bills in the amount of \$945,952.99 (Operating Fund) & \$205,446.28 (Cafeteria Fund) for November have been presented and reviewed by the Hopewell City School Board.

Approval of Supplemental Appropriation
FY24 #3
23-12-G2

RESOLVED, upon the recommendation of the Superintendent of Schools, that the supplemental appropriation to the Operating Fund, in the amount of \$558,975.11 for new state grants be and is hereby approved to be added to FY24.

School Security Equipment Grant \$216,237.00
Title IVA Stronger Connections Grant \$342,738.11



General Resolutions for February 8, 2024

Warrants

Review of Bills

January

24-02-G1

RESOLVED, upon the recommendation of the Superintendent of Schools, that bills in the amount of ***\$1,499,415.39***(Operating Fund) & ***\$75,795.24***(Cafeteria Fund) for January have been presented and reviewed by the Hopewell City School Board.

Approval of Supplemental Appropriation

FY24 #4

24-02-G2

RESOLVED, upon the recommendation of the Superintendent of Schools, that a supplemental appropriation to the Operating Fund, in the amount of ***\$394,240*** for a new state grant be and is approved to be added to FY24.

Department of Behavioral Health and Developmental Services (DBHDS) Grant
\$394,240.00

R-5



CITY OF HOPEWELL CITY COUNCIL ACTION FORM

Strategic Operating Plan Vision Theme:

- Civic Engagement
- Culture & Recreation
- Economic Development
- Education
- Housing
- Safe & Healthy Environment
- None (Does not apply)

Order of Business:

- Consent Agenda
- Public Hearing
- Presentation-Boards/Commissions
- Unfinished Business
- Citizen/Councilor Request
- Regular Business
- Reports of Council Committees

Action:

- Approve and File
- Take Appropriate Action
- Receive & File (no motion required)
- Approve Ordinance 1st Reading
- Approve Ordinance 2nd Reading
- Set a Public Hearing
- Approve on Emergency Measure

COUNCIL AGENDA ITEM TITLE: Request to apply for funding through the Virginia Recreational Trails Program

ISSUE: The funding assistance is in the form of a reimbursement grant in the amount of \$280,000. **If** Friends of the Lower Appomattox River receives a grant for \$100,000, **then** we can potentially use those funds as the city’s match, as this grant is an 80/20 reimbursement grant.

RECOMMENDATION: Staff recommends approval to apply for the Virginia Recreational Trails Program for Riverwalk Phase III Design and Engineering.

TIMING: Staff recommends action at the April 23, 2024 City Council to provide ample time to complete the grant application by the deadline of May 7, 2024.

BACKGROUND: The Virginia Recreational Trails Program was established to provide and maintain recreational trails and is administered by the DCR. The funding assistance would allow the city to complete the design and engineering stage of the Riverwalk Phase III project. **If** Friends of the Lower Appomattox River receives a grant for \$100,000, **then** we can use those funds as the city’s match, as this grant is an 80/20 reimbursement grant.

ENCLOSED DOCUMENTS: 2024 RTP Application Manual.

STAFF: Tabitha Martinez, Recreation and Parks Director

SUMMARY:

- | Y | N | | Y | N | |
|--------------------------|--------------------------|-----------------------------------|--------------------------|--------------------------|--|
| <input type="checkbox"/> | <input type="checkbox"/> | Councilor Rita Joyner, Ward #1 | <input type="checkbox"/> | <input type="checkbox"/> | Councilor Janice Denton, Ward #5 |
| <input type="checkbox"/> | <input type="checkbox"/> | Councilor Michael Harris, Ward #2 | <input type="checkbox"/> | <input type="checkbox"/> | Councilor Brenda Pelham, Ward #6 |
| <input type="checkbox"/> | <input type="checkbox"/> | Mayor John B. Partin, Ward #3 | <input type="checkbox"/> | <input type="checkbox"/> | Councilor Dominic Holloway, Sr., Ward #7 |
| <input type="checkbox"/> | <input type="checkbox"/> | Vice Mayor Jasmine Gore, Ward #4 | | | |

FOR IN MEETING USE ONLY

MOTION: _____

Roll Call

SUMMARY:

- | Y | N | |
|--------------------------|--------------------------|-----------------------------------|
| <input type="checkbox"/> | <input type="checkbox"/> | Councilor Rita Joyner, Ward #1 |
| <input type="checkbox"/> | <input type="checkbox"/> | Councilor Michael Harris, Ward #2 |
| <input type="checkbox"/> | <input type="checkbox"/> | Mayor John B. Partin, Ward #3 |
| <input type="checkbox"/> | <input type="checkbox"/> | Vice Mayor Jasmine Gore, Ward #4 |

- | Y | N | |
|--------------------------|--------------------------|--|
| <input type="checkbox"/> | <input type="checkbox"/> | Councilor Janice Denton, Ward #5 |
| <input type="checkbox"/> | <input type="checkbox"/> | Councilor Brenda Pelham, Ward #6 |
| <input type="checkbox"/> | <input type="checkbox"/> | Councilor Dominic Holloway, Sr., Ward #7 |

Virginia Recreational Trails Program 2024 Application Manual



RTP grant information produced by the Virginia Recreational Trails Program is guidance. This document can be updated or changed at any time pending input or program changes by the Federal Highway Administration.

Table of Contents

I.	Virginia Recreational Trails Program Overview	3
II.	Eligibility	4
III.	Project Categories and Available Funding.....	5
IV.	Application Procedures and Selection Process	6
V.	Award Timeline.....	7
VI.	Programmatic Requirements.....	8
VII.	Eligible Project Costs and Applicant Share	10
VIII.	Reimbursement Procedures.....	12
IX.	Project Administration.....	14
X.	Appendices.....	17
	Appendix A - Application Resources	
	Appendix B - Accessibility Resources	

The following documents, available on the DCR RTP website at <https://www.dcr.virginia.gov/recreational-planning/traillnd>, should be referenced or used along with this manual:

- **RTP Procurement Procedures**
- **RTP Environmental Review and Public Comment Requirements**
- **2024 Recreational Trails Program Application**
- **2024 Recreational Trails Program Application Certification Form**
- **2024 RTP Scoring Criteria**

I. Virginia Recreational Trails Program Overview

The Recreational Trails Program (RTP) is an 80%-20% matching reimbursement program established for the purposes of developing and maintaining recreational trails and trail-related facilities. The Federal Highway Administration (FHWA) allocates funds to each state and provides oversight to state agencies who administer the program. The agency responsible for administering the program in Virginia is the Department of Conservation and Recreation (DCR).

The RTP requirements mandate that each year's apportioned funds be specifically divided among three categories: 30% for motorized trail uses, 30% for non-motorized trail uses, and 40% for multi-use/ diversified trail uses.

Entities eligible to receive funding include town, city, and county governments, tribes, recreation agencies and regional recreation authorities, and state agencies. Non-profit organizations, with support from the local governmental body, are also eligible to receive funding.

The RTP is a reimbursement program, meaning that the applicant must be capable of financing the project upfront while requesting periodic reimbursements. The program will reimburse up to 80% of eligible project costs included in the project authorization request. Recipients are responsible for at least 20% of project costs. Selected applicants enter into a grant agreement with DCR that outlines the maximum funding amount, scope of work, and other requirements for their project.

Projects are selected and recommended for funding through an annual open grant round. All proposals are reviewed and scored by the Virginia RTP Advisory Committee.

Projects recommended for funding must complete an environmental analysis prior to construction in accordance with federal and state regulations. These costs can be included in the grant proposal.

The application deadline for the 2024 RTP grant cycle is **4:00PM on Tuesday, May 7, 2024**. All applications must be submitted electronically via email to recreationgrants@dcr.virginia.gov by this deadline. Applicants are responsible for delivery by the deadline; late submissions will not be accepted.

Programmatic Changes for 2024

Applicants should familiarize themselves with this manual in its entirety, however the following list outlines the **most significant** changes to the RTP program from the 2023 RTP grant round. Each of these points is discussed in further detail within this manual:

- **Both construction of new trails and water trail access points and maintenance and amenity projects on existing trails are eligible for funding this year.**
- Most projects will qualify for exemption of Buy America requirements for iron, steel, construction materials, and manufactured products. This makes equipment purchases now eligible for funding.
- Updated guidance documents on procurement and environmental review procedures.
- Changes have been made to the application questions and scoring criteria.

II. Eligibility

Eligible Entities - RTP funding may be awarded to any of the following:

- Municipalities (cities, towns, counties, etc.);
- Tribes;
- State agencies (Dept. of Forestry, Wildlife Resources, etc.);
- Federal government agencies (combined total of RTP funds and matching federal agency funds cannot exceed 95% of project cost in certain circumstances);
- Other government entities (regional park authorities, etc.);
- Non-profit organizations [requires letters of support from landowner (if property not owned by applicant) and local government body].
 - If selected, non-profit organizations may be asked to provide additional financial records and documentation on land use agreements.

Eligible Projects – RTP funding may be used for:

- Construction of new recreational trails and trail linkages;
- Maintenance and restoration of existing recreational trails;
- Development and rehabilitation of trailside and trailhead facilities and/or amenities on land and water trails;
- Provision of features that facilitate access and use of trails by persons with disabilities;
- Lease or purchase* of recreational trail construction and maintenance equipment;
*Applicants should discuss proposed equipment purchases with DCR Recreation Grants staff to verify eligibility prior to application submission.
- Acquisition of easements and fee simple title to property for recreational trails or recreational trail corridors; and
- Assessment of trail conditions for accessibility and maintenance.

Recreational trails are defined in the RTP regulations as a thoroughfare or track across land or snow used for recreational purposes. These recreational purposes can include:

- traditional pedestrian-oriented activities such as hiking and jogging;
- skating and skateboarding;
- equestrian activities;
- bicycling and mountain biking;
- activities on water trails such as kayaking and canoeing; and
- motorized recreational activities such as all-terrain, utility-terrain, or other off-road vehicle riding, motorcycling, motor boating on water trails, and electric biking.

Uses Not Permitted - RTP funding may not be used for:

- Condemnation of any kind of interest in property.
- Upgrading, expanding, or otherwise facilitating motorized use or access to trails that prior to May 1, 1991, were predominantly used by non-motorized trail users, and on which motorized use was either prohibited or had not occurred.
- Planning proposals, gap analysis, and feasibility studies.

- RTP funds cannot be used to provide sidewalks along or adjacent to public roads or streets. The Virginia Department of Transportation may have funding available to assist with these types of facilities.

III. Project Categories and Available Funding

Categories

RTP Legislation (23 U.S.C. 206) dictates categorical requirements for the use of each state's RTP apportionment: 40 percent of funds apportioned be used for diverse recreational trail use, 30 percent for motorized recreation, and 30 percent for non-motorized recreation.

- **Diversified use project:** A project primarily intended to benefit more than one mode of recreational use such as: walking, bicycling, and skating; or both pedestrian and equestrian use; or pedestrian and mountain biking. A diverse use project may also include both motorized and non-motorized uses where motorized use is not the predominant use or when the motorized and non-motorized uses are separated by season, such as equestrian use in summer and snow sports use in winter.
- **Non-motorized project for a single use:** A project primarily intended to benefit only one mode of non-motorized recreational trail use, such as pedestrian only, or equestrian only, or mountain biking only. RTP projects serving various pedestrian uses (such as walking, hiking, running, bird-watching, nature interpretation, backpacking, etc.) constitute a single use for the purposes of this category.
- **Motorized use project:** A project primarily intended to benefit motorized use. A project may be classified in this category if the project serves only one mode of motorized recreational use or more than one mode of motorized recreational use. A project may be classified in this category if the project also benefits some non-motorized uses (it is not necessary to exclude non-motorized uses), but the primary intent must be for the benefit of motorized use.

DCR staff can aid applicants to determine the category their project fits into.

Available Funding by Category

The approximate funds available for the 2024 grant round as per the fiscal year 2024 FHWA apportionment and remaining funds from completed project underruns are as follows:

- **Diversified category** - \$945,000 available
 - Minimum request - \$50,000, maximum request - \$350,000
- **Non-motorized single use category** - \$435,000 available
 - Minimum request - \$50,000, maximum request - \$250,000
- **Motorized category** - \$630,000 available
 - Minimum request - \$50,000, maximum request - \$630,000*

*There is no maximum request in the motorized category due to historically few applications being received. However if multiple competitive applications are received, award amounts may be less than requested. Note grant awards of \$500,000.00 and up do not qualify for the Build America, Buy America materials waiver discussed in under procurement heading.

It is anticipated that 3-5 grants may be awarded in the diversified category, 2-3 grants in the non-motorized category, and 1-3 grants in the motorized category. **The actual number of grants awarded, and dollar value of the award is contingent upon committee evaluation and the amount of RTP funding available to Virginia at the time of grant award selections.**

IV. Application Procedures and Selection Process

Application Procedures

1. Read this manual in its entirety. It reflects the most recent guidance on the RTP program and supersedes previous guidance materials distributed by DCR.
2. Review the scoring criteria and application resources posted with this manual.
3. Download the RTP application form and certification form from the [DCR RTP website](#). The application is a fillable Microsoft Word document. Questions are answered by typing or pasting into the space provided. The certification form is a fillable PDF and requires a signature.

If you are unable to download or use the documents, please contact recreationgrants@dcr.virginia.gov or 804-786-1119 to obtain an alternative format of the application.

4. Complete the application. All questions should be answered in the space available. Be clear and concise. Only attach additional pages when instructed to do so (listed at the end of each section of the application). Failure to follow these instructions may disqualify the application.
5. Submit the certification form, application, and attachments as a single PDF via email (max email size 25MB) to recreationgrants@dcr.virginia.gov by **Tuesday May 7th, 2024 at 4:00 pm**.

If your email with attachments exceeds 25 MB, contact recreationgrants@dcr.virginia.gov at least two business days prior to the deadline to discuss using an alternative submission method.

If you do not receive a reply acknowledging receipt of your electronic submission within one business day of submission, please contact DCR at the email or phone number listed above to ensure your application was received.

Selection Process

1. Applications received by the deadline undergo a preliminary review by DCR staff to verify application completeness and project eligibility.
2. All eligible and complete applications are sent to the Virginia Recreational Trails Program Advisory Committee for review and scoring.
3. The Virginia Recreational Trails Advisory Committee meets to review all scores and recommend projects for funding.
4. Applicants of projects recommended for funding are contacted by DCR and a site inspection is scheduled.
 - a. Applicants not recommended for funding will also be notified at this time.
5. DCR staff conduct a site inspection to ascertain field conditions and suitability for recommendation to FHWA.
6. DCR staff work with the applicant to gather information and prepare the necessary forms to submit the project for FHWA approval and authorization.
7. Projects authorized by FHWA are issued a project agreement that allows 3 years to complete the required environmental review process, design plans (if applicable), permitting, and project construction.

V. Award Timeline

The anticipated timeline for the 2024 grant cycle is as follows:

March 12, 2024	Grant round opens
April 2, 2024 1:00PM	Informational webinar (registration information available at and post-webinar recording posted to DCR RTP website)
May 7, 2024 4:00PM	Application deadline
May – June 2024	Applications reviewed by DCR and Advisory Committee
Late June 2024	Applicants of projects recommended for funding are contacted
July 2024	Applicants not recommended for funding are notified
July 2024	Site inspections and preparing documents for FHWA authorization request
August 2024	Project authorizations and release of grant agreements
September 2024	Agreement execution

VI. Programmatic Requirements

Right of Way

Applicants should have the right of way secured (deed, easement/s, license agreement, etc.) *prior* to applying for RTP funding. The preference for federal-aid investments is that access to the trail should be in perpetuity, however DCR will prioritize projects with legal access to the project right of way for at least a 20 year period.

- **Work on Public Lands**

Applicants submitting proposals for work on lands owned by another public entity are required to enter into a separate legal agreement with that public entity to undertake the work described in the RTP application. A copy of this agreement, or a draft if the agreement is pending, must be included with the RTP application.

- **Work on Private Lands**

Public access to private lands must be secured at the time of application. A right of way agreement must already be in place prior to application. Applicants submitting proposals for work on privately owned land must submit a copy of the relevant recorded deed, easement, license, or agreement with the RTP application.

Access for People with Disabilities

Recipients of federal financial assistance, including subgrantees, must comply with Section 504 of the Rehabilitation Act of 1973, as amended (29 U.S.C. § 794). This legislation states that:

No otherwise qualified individual with a disability in the United States...shall, solely by reason of...disability, be excluded from the participation in, be denied the benefits of, or be subjected to discrimination under any program, service, or activity receiving federal financial assistance.

There is also a nearly identical mandate in the Americans with Disabilities Act (ADA), which applies to state and local governments and public accommodations of businesses and non-profit organizations. Most entities applying for RTP funding must follow both this provision and the 2010 ADA Standards for Accessible Design.

While there currently are no minimum standards for trails and related outdoor recreation amenities in the ADA standards, entities must not discriminate against people with disabilities in the programs and activities they offer, which includes trails. The best available guidance is to follow, at a minimum, the federal outdoor accessibility standards of the Architectural Barriers Act (ABA). The ABA Accessibility Standards (ABAAS) can be found at <https://www.access-board.gov/aba/>. In most cases, ABAAS are identical to the 2010 ADA Standards. However, ABAAS includes additional provisions for outdoor recreation areas including trails, trailheads, campgrounds, picnic areas, and viewing areas. A guide for these standards can be found at <https://www.access-board.gov/aba/guides/chapter-10-outdoor/>. Exceptions are only permitted in limited circumstances. For technical assistance on the ABA Standards, contact the U.S. Access Board at 202-272-0080 or ta@access-board.gov. For

technical assistance on the ADA, contact the Department of Justice at 800-514-0301 (voice) or 1-833-610-1264 (tty).

The ADA and ABA standards primarily address access for people with disabilities that impact mobility. Entities will also need to demonstrate how their project provides equitable experiences for users with sensory, cognitive, neurological and/or mental health disabilities.

Additional accessibility resources can be found in Appendix B.

Note that these requirements do not preclude any state or local accessibility laws or standards that provide greater accessibility than those discussed above.

Project applications must describe *how* a project will provide access for people with disabilities, not simply state that the project will comply with all legal requirements.

Environmental Review

All projects must complete an environmental analysis prior to construction in accordance with the National Environmental Policy Act (NEPA) and at a minimum compliance with the Endangered Species Act, Historic Preservation Act, and Executive Orders 11988 and 11990: Floodplain Management and Wetlands Protection. A Federal Consistency Determination in accordance with the Coastal Zone Management Act may also be required. Additional information is provided in the RTP Environmental Review Guidance document posted on the [DCR RTP website](#).

Procurement

All RTP projects must comply with [2 CFR 200.317-327](#), the [Virginia Public Procurement Act](#) (VPPA), and local entity procurement standards, as well as other applicable state and federal procurement regulations. Please review the **RTP Procurement Procedures** document available at the [DCR RTP website](#) for additional details on required procurement procedures. Important points include:

- **Small, Women-owned and Minority-owned Businesses (SWaM) and Disadvantaged Business Enterprises (DBE)** - all RTP recipients must take appropriate and reasonable steps to provide SWaM and DBE with the maximum opportunity to compete for and perform contracts for trail projects receiving aid through the program. Documentation of SWaM and DBE outreach efforts must be submitted.
- **Construction Bidding** – All construction contracts must be competitively bid, unless the procurement qualifies under the locality’s established small purchase procedures in accordance with the Virginia Public Procurement Act. Additionally, at least two bids must be received for construction contracts, otherwise the project must be re-bid.
- **Buy America** – Projects authorized after August 2023 utilizing less than \$500,000 of federal funding are exempt from Build America, Buy America requirements for iron, steel, construction materials, and manufactured products. Projects with \$500,000 or more in federal funding or those authorized prior to this date are not exempt. Material certification documentation proving the material was sourced and manufactured in the U.S may be required.

- **Equipment Purchases** – In accordance with 2 CFR 200.313, recipients are limited in how equipment purchased with RTP funds can be used and must report on the status of equipment every two years following grant closeout. Applicants should discuss proposed equipment purchases with DCR Recreation Grants staff prior to application submission. If grant-purchased equipment is sold or disposed before the value falls below \$5,000 a portion of grant funds may require repayment to FHWA.
- **DCR Administrative Review** – Drafts of select procurement documents must be submitted for DCR administrative review before proceeding at various steps of the procurement process.
- **Recordkeeping** - The subgrantee must maintain records sufficient to detail the history of all procurements and is responsible for submitting certain procurement records to DCR. These records should include: final solicitation/advertisement, final Invitation for Bid or Request for Proposals, bid/response spreadsheet listing all bids/responses received, executed contract, and summary of the RTP recipient's efforts to comply with the RTP DBE and SWaM Policy.

Recipients are responsible for ensuring that all contracts are in compliance with federal and state laws concerning the solicitation of supplies, equipment, and services. When conflicts exist, DCR must be contacted for consultation with the FHWA. If any project components or services are not procured per the applicable standards, those expenses will not be eligible for RTP reimbursement and the project may be withdrawn and any previous payments received returned to FHWA.

Facility Life

The preference for federal-aid investments is that the public interest in and access to the trail should be in perpetuity. However, it is understood that facilities and features will have associated life expectancies/ lifespans. The greater the amount of federal funding involved, the greater expectation for a long facility life. All RTP projects should be designed and built for longevity and must submit maintenance plans with the application.

VII. Eligible Project Costs and Applicant Share

Eligible Project Costs

The following list represents costs that *may* be eligible for reimbursement on a project. All project costs must be outlined in the project proposal and budget and approved in the project agreement.

- Costs to conduct required environmental review for NEPA and Section 106 compliance
- Costs associated with project engineering and design
- Construction, rehabilitation, and maintenance work on trails
- Construction of bridges, railings, ramps, fences, and retaining structures
- Bank stabilization, re-vegetation (excluding ornamental landscaping), erosion control
- Trailhead development including parking, restrooms, and related facilities

- Motorized boat launches and non-motorized paddle launches on water trails
- Signs and interpretive aids
- Features that facilitate trail use by people with disabilities
- Consultant/ contractor services
- Equipment rental or purchase
- Bid advertisements for project-related work
- Employee salary for on-the-ground project work in the field
- Costs to administer the project and the grant when agreed upon up front and documented correctly (does not include general overhead costs)
- Environmental review and engineering costs incurred less than 18 months prior to FHWA authorization *may* be counted towards the applicant's 20% share in limited circumstances. These services must have been procured following the procurement requirements outlined in the RTP Procurement Procedures document and require documentation including invoicing and proof of payment specific to the project to prove this. Discuss with the DCR grant administrator if you wish to include these costs. **No other costs incurred prior to authorization are eligible.**

Matching Share Requirement

Of the eligible total project costs, the RTP program will reimburse 80% of approved costs. The other 20% remains the responsibility of the applicant. This 20% contribution from the applicant is referred to as the non-federal or matching share. Another way to determine the required match amount is to calculate 25% of the grant award amount.

Example: If a grant is awarded for \$100,000, applicants must provide \$25,000 in match, making the total project cost \$125,000. The 80% RTP share is \$100,000 and the 20% matching share is \$25,000.

The simplest way for entities to provide their 20% share is to directly pay for eligible items, and the program will then reimburse the entity at 80%, leaving the 20% share. However, many other items can be used towards the matching share with appropriate documentation, including:

- Force account labor (employees of entity working on the project, either in-field or in project/grant administration);
 - Timesheets, proof of salary, and proof of payment to the employee are required.
- Donation of private funds;
- Value of volunteer and/or in-kind labor, donated and/or in-kind equipment, donated and/or in-kind materials, at fair market value;
 - These items may only be used to cover recipient's 20% share and are never a reimbursable expense, i.e. cannot receive cash reimbursement for item that was not actually spent in cash. Volunteer, in-kind, and donation values exceeding the 20% share will not be reimbursed.
 - General volunteer labor rate calculated using current independentsector.org rate for Virginia. As of February 2024, the posted rate was \$32.59 per hour.
 - In kind equipment costs will require a time log, other items require proof of fair market value determination.
- Other federal, state, local, and private grants;

- Eligible as long as the requirements are not in conflict RTP regulations.
- In some cases, combined federal funds cannot exceed 95% of the total project costs. Any projects planning to use federal funds for more than 95% of the total project costs should consult with DCR prior to submission.

All volunteer or in-kind labor; donated or in-kind materials, equipment, and services; and in-house or consultant administrative costs must meet three primary requirements to be eligible:

1. They must be clearly outlined in the project application narrative and proposed budget.
2. They must be included in the FHWA authorization and signed agreement, and
3. They must have proper documentation.

The value of donations and in-kind items cannot be added to the budget after authorization.

The two examples below illustrate how donated labor and materials can be used to cover the non-federal share:

#1	<u>Total Project Cost</u>	\$40,000
	Cost of materials	\$20,000
	Cost of county work forces (Force Account)	\$12,000
	Value of private volunteer labor	\$8,000

Maximum RTP reimbursement on the above project is \$32,000. The sponsor actually spent \$32,000 on materials, services, and work forces, and then added the volunteer labor to the local match. The recipient would receive a grant reimbursement of \$32,000 which is also the full 80% of overall project cost.

#2	<u>Total Project Cost</u>	\$40,000
	Cost of materials	\$8,000
	Cost of county work forces (Force Account)	\$8,000
	Value of donated materials	\$12,000
	Value of private volunteer labor	\$12,000

Maximum RTP reimbursement on the above project is \$16,000. The total paid expenditures on the project equal \$16,000. The total value of donated materials and labor is \$24,000. Therefore, the maximum allowable reimbursement amount is \$16,000 or the cost of materials and work forces. The recipient does not receive the full 80% of the project cost because only \$16,000 of the costs were paid in cash.

VIII. Reimbursement Procedures

RTP is a reimbursement program; therefore, the RTP recipient must pay 100% of the cost of any item before submitting a request for reimbursement of 80% of costs. The recipient must have cash on hand or other financing available to cover all project expenses until reimbursement is received.

Reimbursement requests can be submitted as soon as documentation of the payment (cleared check, ACH statement, bank statement) is available. However, since banks sometimes only release that documentation monthly, there can be a 1-3 month delay between incurring the expense, the availability of payment verification documentation, document submission to DCR, DCR and FHWA processing, and receiving reimbursement.

Reimbursement requests must be submitted via email. Regular reimbursements requests must be submitted to maintain the project in active status. Specific deadlines will be provided in the grant agreement.

Reimbursement request submissions must include:

1. Signed certification cover sheet (template provided);
2. The following summary sheet/s, as applicable (templates provided):
 - a. Data sheet summarizing invoices,
 - b. Data sheet summarizing employee labor,
 - c. Data sheet summarizing volunteer labor,
 - d. Data sheet summarizing in-kind equipment records;
3. Documentation of each expense specific to the RTP project (invoice, billing statement, signed timesheets, signed daily volunteer work log, documentation of value determination for donated materials, volunteer time, etc.);
4. Proof of payment for each expense (cleared check- front and back, or other document confirming vendor receipt of payment such as: ACH statement, bank statement, or payroll ledger);
5. Additional documentation as requested by DCR.

Once received, DCR reviews the request and follows up with the recipient if any additional documentation is needed. DCR then prepares the forms and submits to FHWA to process the reimbursement. Once approved, FHWA releases the funds to DCR, and then DCR sends the reimbursement to the recipient.

Additional guidance on reimbursement procedures and templates of forms used in the reimbursement process can be found under "Documents and forms for grant recipients" on the [DCR RTP website](#).

IX. Project Administration

FHWA Authorization and Grant Agreements

DCR will collect the necessary information from applicants to submit a project to FHWA for approval and authorization. FHWA will review the project and if found to meet all program requirements, will authorize the project and project scope for a specific amount of funding.

Once a project is authorized by FHWA, a grant agreement between DCR and the applicant (now called the *subgrantee or subrecipient*) is created and signed by both parties. This agreement outlines program rules and regulations, approved scope of work, approved budget, approved non-federal share items, and reporting requirements. **Do not incur costs that you are submitting for reimbursement until project is authorized by FHWA and a DCR-subgrantee agreement is signed.**

Project Management

One person should be assigned as the project coordinator, with at least one additional person designated as backup. The project coordinator will have the responsibility for all coordination with DCR. All grant communication and deliverables should be submitted to recreationgrants@dcr.virginia.gov NOT to individual DCR staff email addresses.

Quarterly Reports

Recipients of RTP funding must submit quarterly reports providing the status of the trail project. A template is provided that also indicates the required information. Reports are due via email every three months (reporting periods end on last day of March, June, September, December). The first report due date will be identified in the project agreement. It is the responsibility of the recipient to submit the status reports to DCR.

Record Retention

All program and financial records shall be retained by the subgrantee for state and federal audit purposes during and following completion of the project for a minimum of 3 years.

Administrative Review of Project Documentation

Plans, environmental analysis documents, and bid documentation must be administratively reviewed by DCR prior to the start of construction on the project. Administrative review is defined as a review of bidding documents, construction plans, specifications and/or contractual documents to determine consistency with the approved Recreational Trail Program scope of work. DCR's administrative review of these items and permission to proceed shall not be considered a professional architectural, engineering, or legal review or an endorsement of design practices and standards.

Plans which include the design of structural components, such as trail bridges, tunnels, or scenic overlooks, must be stamped, signed and dated by a Licensed Professional Engineer.

Grant Phases

RTP projects have two phases. The first phase is preliminary engineering (PE). The preliminary engineering phase provides time and funding to assist in completing the required environmental review, final design plan specifications, and permitting. **No bidding or on-the-ground work may begin before the PE Phase is complete and the NEPA pathway document is signed by FHWA.**

- **Preliminary Engineering Phase** – the PE phase assists with the cost associated with performing the studies and analysis needed to address the requirements of the National Environmental Policy Act (NEPA) and other environmental laws. PE phase grants also assist with the completion of design plans and specifications and obtaining required permits. A completed environmental review and supporting documents, including all agency correspondence, must be submitted to DCR for a NEPA pathway recommendation to FHWA. Additional information about the environmental review process can be found in the RTP Environmental Review Guidance document posted on the [DCR RTP website](#).
- **Construction Phase** – the construction phase is for the cost of bid advertisement for construction, construction costs, and may assist with obtaining permits if the permits were not included in the PE phase. Bid documentation must be reviewed by DCR prior to advertisement.

The PE phase should be complete within the first 18 months of the project period, based on project timeline. Overall project period for completion is a maximum of three years from initial project authorization. Projects unable to complete both PE and Construction in three years may be terminated and funds returned for reauthorization to other projects.

Project Completion and Closeout

To close out the grant, a DCR staff site inspection of the completed work is required. The last reimbursement request should be submitted prior to the project end date that includes a written statement of project completion and notice of final reimbursement request. The project completion statement must describe the actual work accomplished, how it differed, if at all, from the original scope of work, and the percentage and dollar value of volunteer, in-kind, donated, and cash contributions. It should also include a report on the total DBE and SWaM, if any, involvement in the project, and photos of the completed work.

Note that if a project is not able to be constructed as agreed upon, RTP funds provided for the project may need to be returned to FHWA. If the subgrantee has any reason to believe construction cannot be completed DCR must be notified immediately.

Changes to Approved Scope of Work

Requests for changes to the project scope outlined in the project agreement must be submitted in writing to DCR. Changes in scope must be approved by DCR and FHWA; FHWA has final authority on eligibility issues and modifications or amendments. If approved, an amendment to the project agreement will be prepared and forwarded to the subgrantee for signature.

Extension Policy

RTP project agreement extensions may be considered, on a case by case basis, based on the following conditions:

1. Unforeseeable *severe* weather conditions prevented project implementation as scheduled; please contact DCR promptly when the project is delayed.
2. Unexpected staff turnover during the project period and after beginning construction, which resulted in new personnel being hired or trained to meet project deliverables; DCR must be notified immediately when the primary contact for RTP project administration changes to ensure proper contact and procedures can be established.
3. Delays due to unexpected environmental concerns.

Conditions that do not warrant an extension include, but are not limited to:

1. Project delays resulting from lack of attention;
2. Extension request on projects where program reporting requirements have not been met;
3. Failure to complete project deliverables in accordance with the project schedule established in grant application and project agreement scope of work;

Administrative Procedure for Extensions

At least **90 days prior** to the agreement expiration date, the RTP recipient must provide a written request to DCR that specifies the reason for the project extension, supporting documentation, and the necessary time period needed to complete the project. Only one extension request per project agreement will be considered. If an extension is approved by DCR, then DCR will request an extension for the project from the FHWA. Final approval of extensions or project modifications are at the discretion of the FHWA. Updates to DCR and FHWA RTP program guidelines may also result in an extension request being denied.

X. Appendices

Appendix A - Application Guidance

This appendix is provided as a supplement to the 2024 VA RTP Application. Please refer to this information while completing the application. It provides instructions on answering specific questions, including directions on how to access web-based mapping software referenced in the application and source links for other data-based questions.

Application Certification Form

Question 2

Provide the contact name and title of the person who will be responsible for direct communication with DCR.

Question 11

If you do not know your organization's Federal Information Processing Standards code, you can use the Virginia Department of Taxation Locality Code Lookup feature at <https://www.business.tax.virginia.gov/fips/index.cfm>.

Application Form

Section I

Question 3

Category maximum requests are listed in Section III. of this manual.

Question 5

RTP project categories are defined in Section III. of this manual.

Question 13

If applicant is a non-profit organization, a letter of support from the locality in which the project is located in must be provided. This letter should indicate the locality's support for the project and its willingness to advise the project sponsor, if needed, on required permitting and public procurement procedures.

Section I Attachments

Location maps can be generated using Google Maps or similar screen captures with pins or arrows identifying the project location. If you do not have an existing trail map, you can make one using DCR's Natural Heritage Data Explorer:

1. To access the Natural Heritage Data Explorer, visit: <https://vanhde.org/> and click on the "Map" tab. A separate browser tab will open. Please read and accept the Terms of Use.

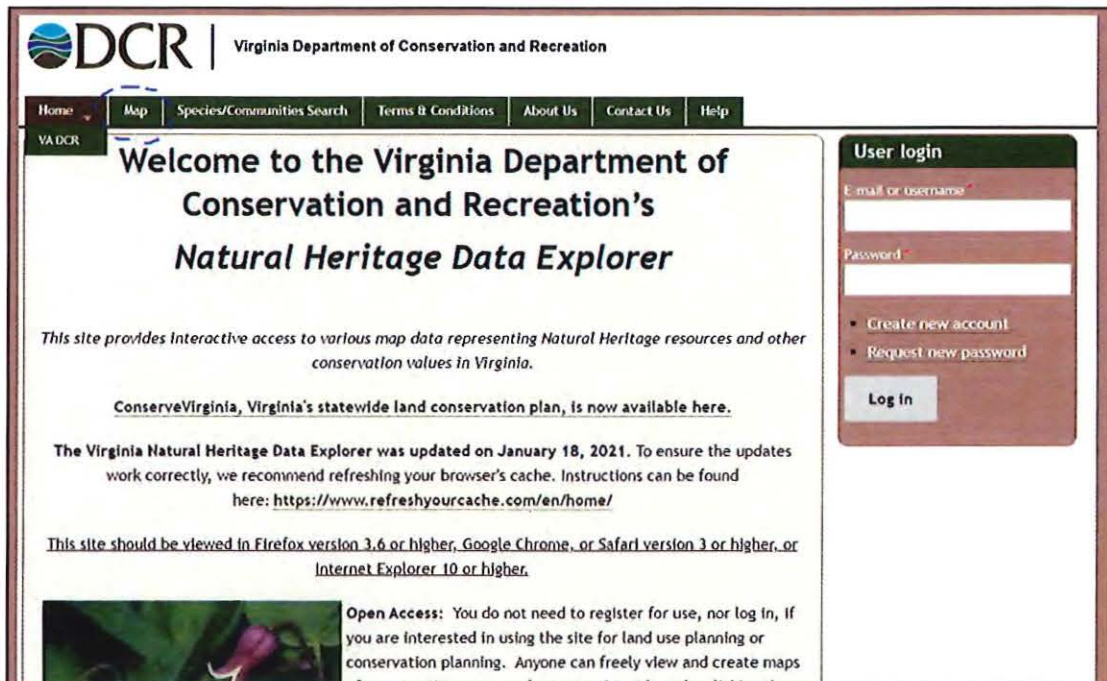

2. Navigate to your location by either using the map's zoom feature, or entering an address into the box in the upper right side of the screen labeled "find address or place."
3. Once your area is located, select the "Make a Map" tab. Note you can switch the basemap to an aerial view by clicking "Switch Basemap" directly above the "Layers," "Make a Map," and "Feature Search" tabs.

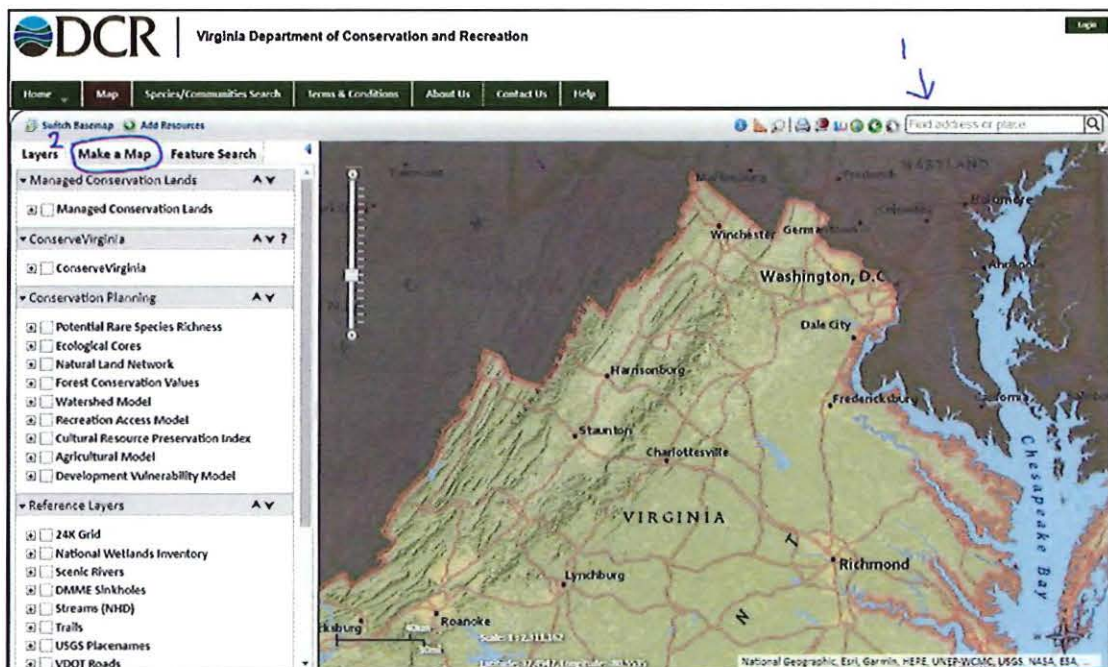

- To create a polygon that defines the subject property, select "Polygons" from the Drawing Type drop-down and click "Add." A drop-down Annotation Settings menu will appear allowing you to adjust the color and transparency of the polygon shape.

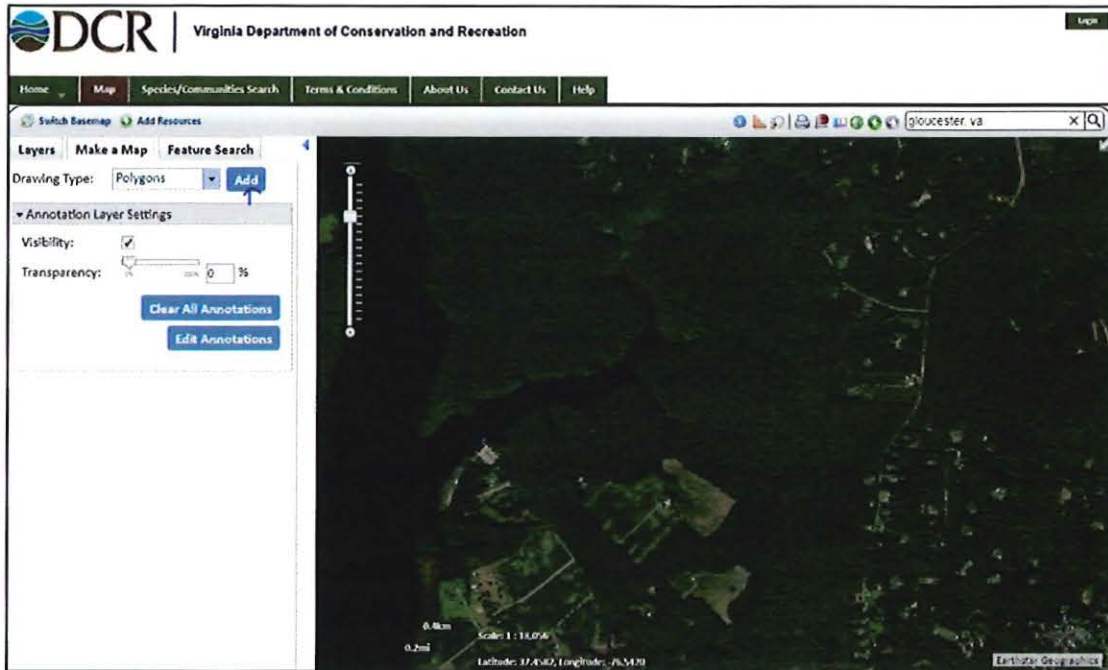

- Draw your polygon by clicking around the edge of your parcel on the map. When the shape is complete, double-click and then click "Accept."

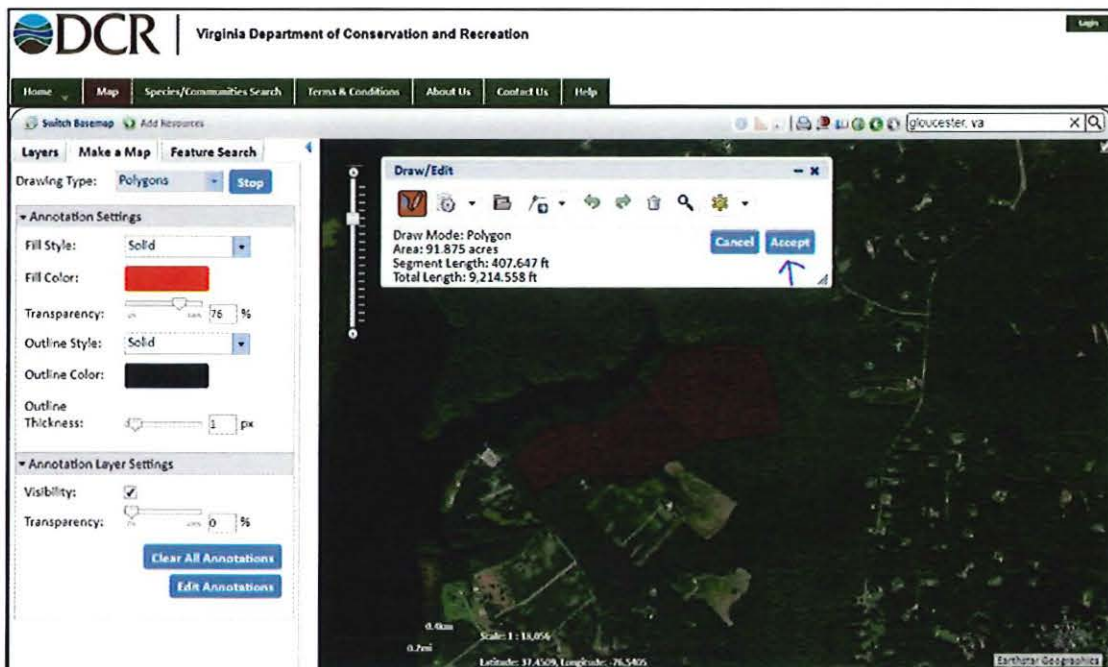

- If you wish to also add a line to indicate the trail layout, select "Line" from the Drawing Type drop-down menu and click "Add." You can select from the same options to change the color and transparency of the line. Once you have drawn the line, double click to complete the line and click "Accept." You can then print your map by either

using the “Print” option on the top right side of the screen, or using your computer’s “Snip” tool.

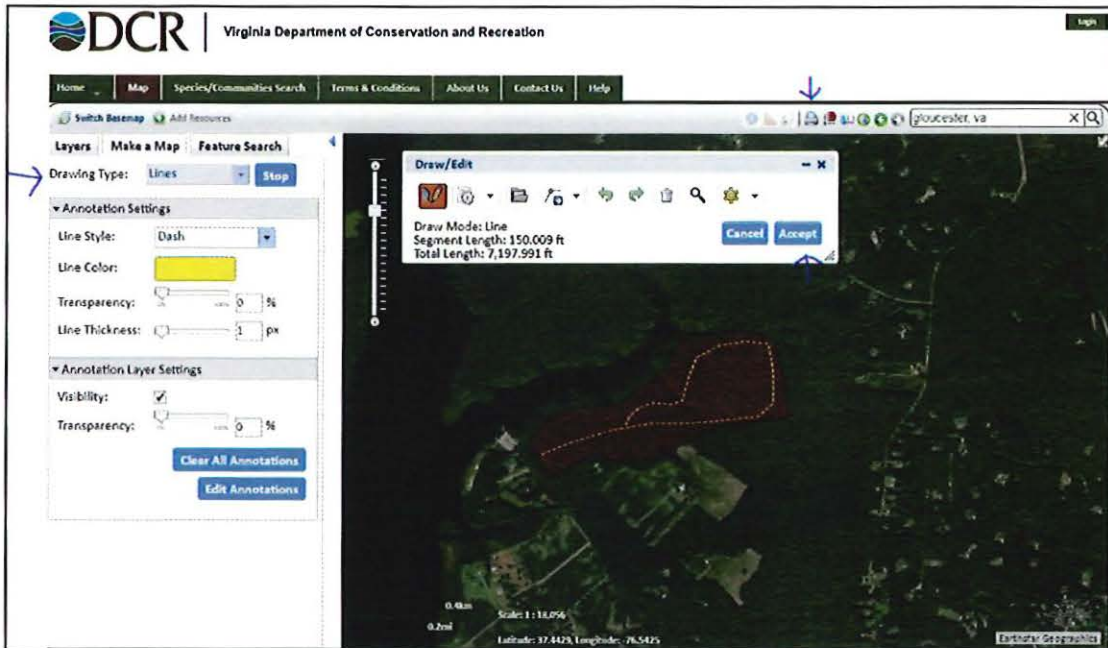

7. If you use the “Print” feature, enter your project details and click “Print.” When the map is ready, the “Print” box will change to “Printout.” Click this and a new window with you map will open. This can be attached to your application.



Section II.A and II.B – Answer the Section II.A questions if your project includes construction of a new trail or trail segment or construction of a new water trail access point. Answer the Section II.B questions if your project includes maintenance or repairs to an existing trail, or construction of new amenities on an existing trail. The unused section may be deleted. If your project includes both new trail construction and additional amenities on an existing trail, answer both parts and the project will be awarded the higher score of the two. If in doubt, contact DCR Recreation Grants staff or complete both A and B and the review committee will determine and score the appropriate section.

Question 15

The project will be evaluated based on the demonstrated recreation need of its location based on the DCR Nature-based Recreation Access Model (2021) and the Trust for Public Lands ParkServe Model. Projects offering land-based trail opportunities will be scored on whichever model demonstrates a greater need. Projects offering water-based (water trail) recreation opportunities will be scored on the Nature-based Recreation Access Model's water-based recreation need rating.

ParkServe can be found at: <https://www.tpl.org/parkserve>.

The Nature-based Recreation Access Model maps can be accessed through DCR's Natural Heritage Data Explorer. Follow steps 1 and 2 outlined for Section I attachments above to access the mapper. Once you have located your area on the map, follow these steps to view the Nature-based Recreation Access Model need rating:

1. Under the Conservation Planning Category on the left side of the screen, check the box next to "Nature-based Recreation Access Model"
2. Expand that drop down and check the box next to "Land-based Recreation Need" (Question 15a) or "Water-based Recreation Need" (Question 15b)

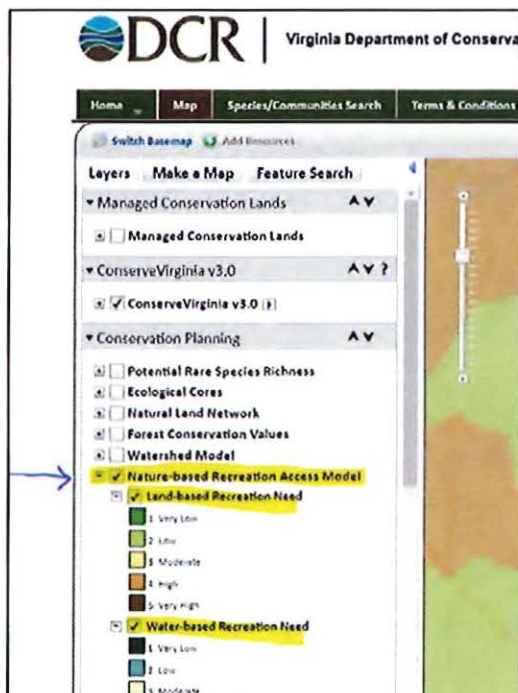

- To find the score for your project area, click the “identify” icon in the top right of the map, next to the triangle and the magnifying glass, and then click on your project location.

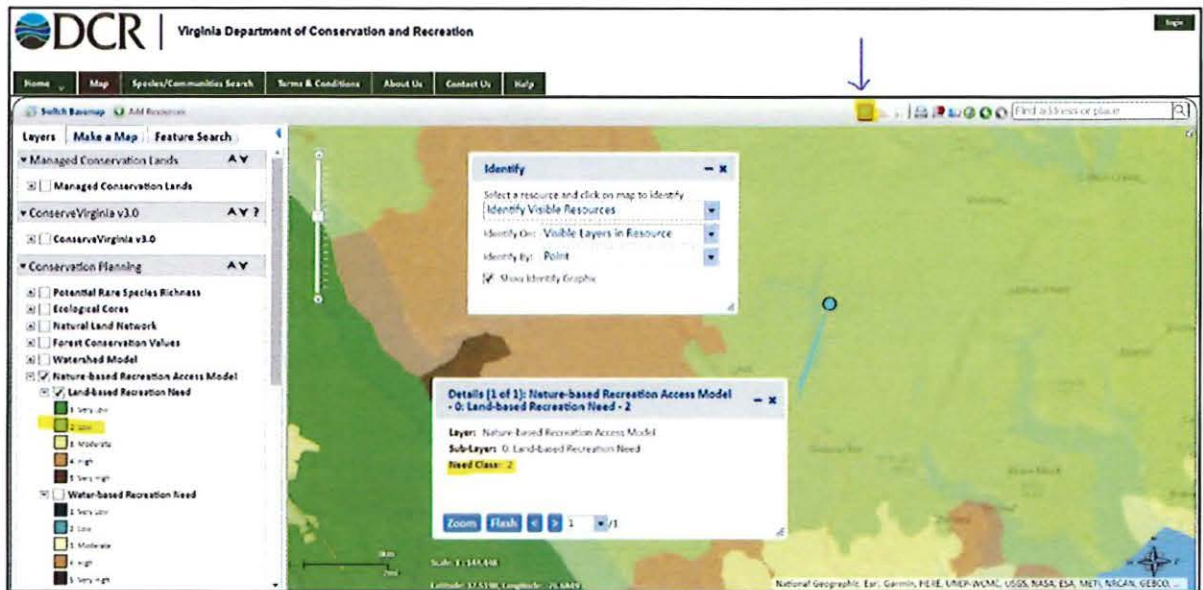

- Two windows will pop up. Within the “Details” window, the “Need Class” number will be listed. This corresponds to one of the five need classes listed in the legend.

Question 16

The ConserveVirginia map can also be accessed through DCR’s Natural Heritage Data Explorer. Follow steps 1 and 2 outlined for Section I attachments above to access the mapper. Once you have located your area on the map, follow these steps to view the ConserveVirginia map:

- Under the ConserveVirginia v3.0 Category on the left side of the screen, check the box next to “ConserveVirginia v3.0”
- Expand that drop down and check the box next to “ConserveVirginia Map.”

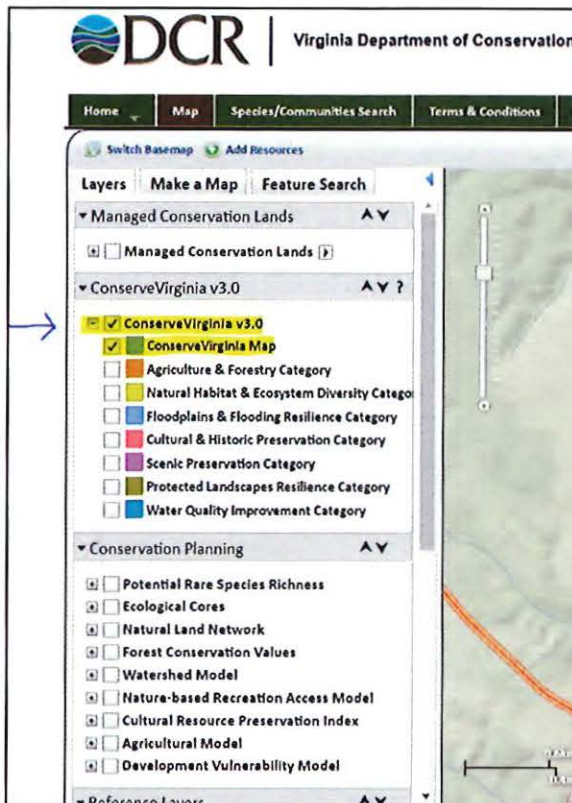

- To find whether your parcel is within ConserveVirginia, click the “identify” icon in the top right of the map, next to the triangle and the magnifying glass.

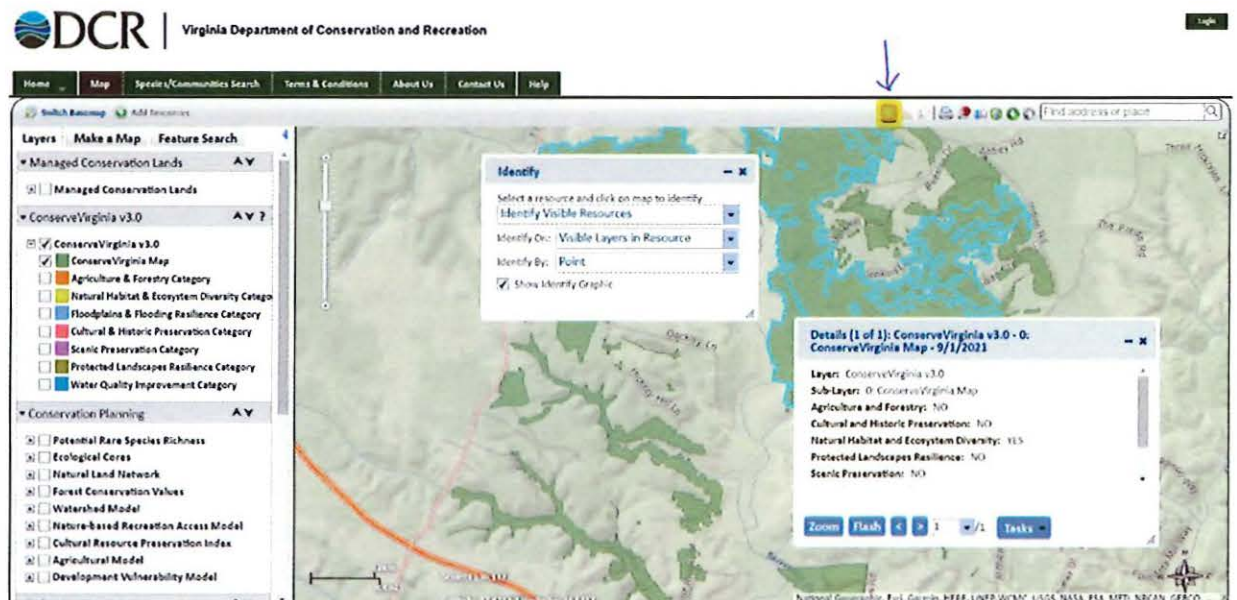

- Two windows will pop up. Within the “Detail” window, it will say “Yes” next to any sub-layer/ category that is within ConserveVirginia. In this case, the identified location is within the Natural Habitat and Ecosystem Diversity layer.

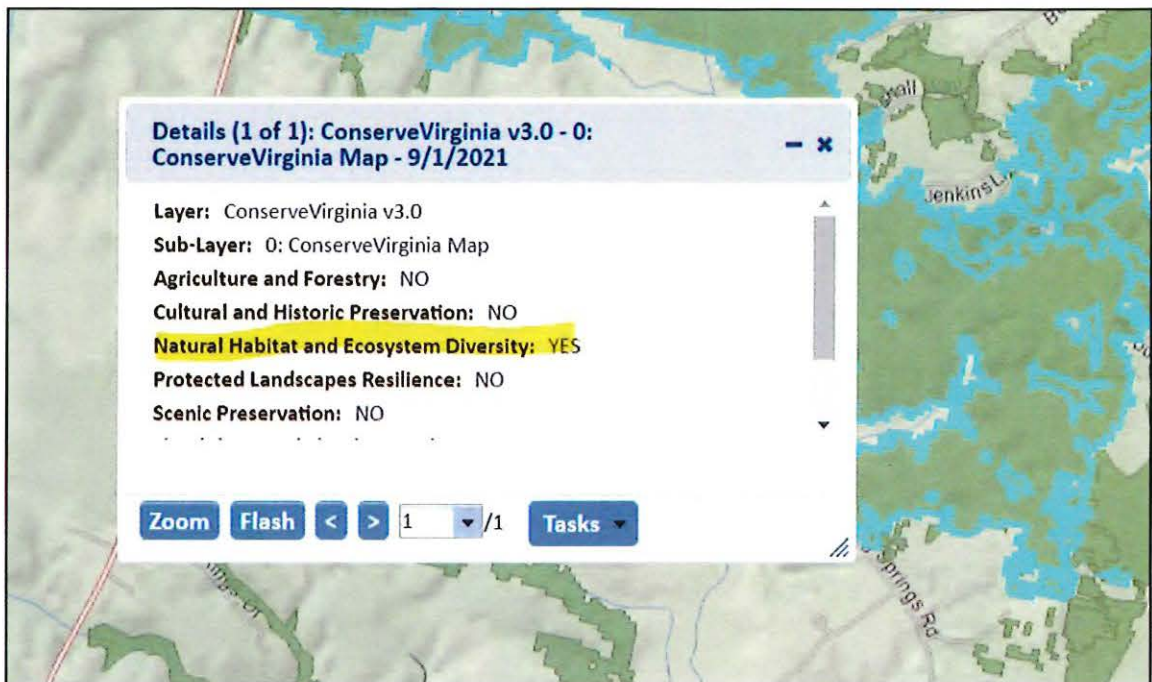

Question 17

The 2018 Virginia Outdoors Plan can be found at <https://www.dcr.virginia.gov/recreational-planning/vop>. A link to the VOP Mapper for identifying blueways and scenic rivers is also on this page.

Section III

Question 27

See Appendix B of this manual for a list of online accessibility resources.

Section IV

Question 31

Review the RTP Procurement Procedures document available at <https://www.dcr.virginia.gov/recreational-planning/traifnd> for overview of procurement procedures required for RTP projects and a description of Buy America applicability to specific projects.

Section V

Question 33

Review the RTP Environmental Review Guidance document available at <https://www.dcr.virginia.gov/recreational-planning/traifnd> for overview of agency correspondence and procedures required to comply with NEPA and Section 106 requirements.

Appendix B - Accessibility Resources

The following resources may aid entities in planning for inclusive trail experiences and understanding legal obligations. As you plan your trail project, consider how your entity will provide equitable experiences for all users, including people with mobility, sensory, cognitive, and mental health disabilities.

2010 ADA Standards for Accessible Design <https://www.access-board.gov/ada/>

Full text of the technical standards that apply to state and local governments, non-profits, and businesses.

ABA Accessibility Standards <https://www.access-board.gov/aba/>

Full text of the technical standards that apply to federal government agencies and some recipients of federal funds.

U.S. Access Board Public Right-of-Way Accessibility Guidelines.

<https://www.access-board.gov/prowag/>

Recently published guidelines for pedestrian facilities in the public right of way, included shared use paths designed for transportation and recreation purposes.

U.S. Access Board Guide to the ABA Accessibility Standards (Outdoor)

<https://www.access-board.gov/aba/guides/chapter-10-outdoor/>

Illustrated guide to the technical requirements of the ABA Outdoor Developed Area standards, which include trails, viewing areas, picnic areas and camping areas.

U.S. Forest Service Accessibility Resources Website

<https://www.fs.usda.gov/managing-land/national-forests-grasslands/accessibility/resources>

Contains links to numerous documents, including the Forest Service Trail Accessibility Guidelines, and other guides, summaries, and best practices.

American Trails Trail Accessibility Hub

<https://www.americantrails.org/resources/accessibility-hub>

Summary collection of accessible land and water trail articles, webinars, guides, bulletins from a variety of sources.

AccessibilityOnline Webinar Archives <https://www.accessibilityonline.org/ao/archives>

Archive of recorded webinars presented by the U.S. Access Board on ADA and ABA standards, including Recreation Facilities and Outdoor Developed Areas.

Massachusetts Audubon Accessible Trails Manual

<https://www.massaudubon.org/get-outdoors/accessibility/accessible-projects-and-partners/accessible-trails-manual>

Summary and recommendations from Mass Audubon detailing their experiences in creating multisensory and inclusive trail environments.

Trails for All People: Guidance for Accessibility and Inclusive Design

<https://conservationtools.org/guides/115>

Guide from WeConservePA with overview of legal requirements and summary of best practices.

REPORTS OF
THE CITY
MANAGER



CITY OF HOPEWELL CITY COUNCIL ACTION FORM

Strategic Operating Plan Vision Theme:

- Civic Engagement
- Culture & Recreation
- Economic Development
- Education
- Housing
- Safe & Healthy Environment
- None (Does not apply)

Order of Business:

- Consent Agenda
- Public Hearing
- Presentation-Boards/Commissions
- Unfinished Business
- Citizen/Councilor Request
- Regular Business
- Reports of Council Committees

Action:

- Approve and File
- Take Appropriate Action
- Receive & File (no motion required)
- Approve Ordinance 1st Reading
- Approve Ordinance 2nd Reading
- Set a Public Hearing
- Approve on Emergency Measure

COUNCIL AGENDA ITEM TITLE: Collective Bargaining Impact Presentation

ISSUE: Presentation regarding the impact of collective bargaining.

RECOMMENDATION: It is the intention of City Council to direct City Administration to begin working on a collective bargaining ordinance and request administration to begin the review of what impacts its implementation for presentation to City Council within 120 days or sooner.

TIMING: No Action Required

BACKGROUND: In April of 2020, the Virginia General Assembly passed legislation permitting local governing bodies to enter into collective bargaining agreements with respect to any matter relating to employment, provided that the local government adopts an ordinance.

ENCLOSED DOCUMENTS: Collective Bargaining Resolution, Rating Impact of Collective Bargaining Letter by Davenport, Collective Bargaining Ordinance

STAFF: Dr. Concetta Manker, City Manager

SUMMARY:

- | Y | N | | Y | N | |
|--------------------------|--------------------------|-----------------------------------|--------------------------|--------------------------|--|
| <input type="checkbox"/> | <input type="checkbox"/> | Councilor Rita Joyner, Ward #1 | <input type="checkbox"/> | <input type="checkbox"/> | Councilor Janice Denton, Ward #5 |
| <input type="checkbox"/> | <input type="checkbox"/> | Councilor Michael Harris, Ward #2 | <input type="checkbox"/> | <input type="checkbox"/> | Councilor Brenda Pelham, Ward #6 |
| <input type="checkbox"/> | <input type="checkbox"/> | Mayor John B. Partin, Ward #3 | <input type="checkbox"/> | <input type="checkbox"/> | Councilor Dominic Holloway, Sr., Ward #7 |
| <input type="checkbox"/> | <input type="checkbox"/> | Vice Mayor Jasmine Gore, Ward #4 | | | |

FOR IN MEETING USE ONLY

MOTION: _____

Roll Call

SUMMARY:

- | Y | N | |
|--------------------------|--------------------------|-----------------------------------|
| <input type="checkbox"/> | <input type="checkbox"/> | Councilor Rita Joyner, Ward #1 |
| <input type="checkbox"/> | <input type="checkbox"/> | Councilor Michael Harris, Ward #2 |
| <input type="checkbox"/> | <input type="checkbox"/> | Mayor John B. Partin, Ward #3 |
| <input type="checkbox"/> | <input type="checkbox"/> | Vice Mayor Jasmine Gore, Ward #4 |

- | Y | N | |
|--------------------------|--------------------------|--|
| <input type="checkbox"/> | <input type="checkbox"/> | Councilor Janice Denton, Ward #5 |
| <input type="checkbox"/> | <input type="checkbox"/> | Councilor Brenda Pelham, Ward #6 |
| <input type="checkbox"/> | <input type="checkbox"/> | Councilor Dominic Holloway, Sr., Ward #7 |

COLLECTIVE BARGAINING RESOLUTION

WHEREAS, in April of 2020, the Virginia General Assembly passed legislation permitting local governing bodies to enter into collective bargaining agreements with respect to any matter relating to employment, provided that the local government adopts an ordinance authorizing as much; and

WHEREAS, pursuant to Section 40.1-57.2 (C), VA Code Ann., any governing body that has not adopted an ordinance providing for collective bargaining may receive an employee certification from a majority of employees who self-identify as a bargaining unit, and within 120 days of receipt of such employee certification, shall take a vote to adopt or not adopt an ordinance or resolution to provide for collective bargaining; the Virginia Code does not require any governing body to adopt an ordinance or resolution authorizing collective bargaining; and

WHEREAS, City Council held a closed session on October ___ 2023 to receive legal advice specifically about the issue of collective bargaining from retained counsel, Cynthia Hudson; and

WHEREAS, Hopewell City Council (City Council) at their City Council meeting on November 14, 2023 requested administration to begin the review of collective bargaining in the City of Hopewell and what impacts its implementation may have on the city; and

WHEREAS, City Council additionally directed administration to research and include studies that have been done by other jurisdictions who have collective bargaining to determine residents' satisfaction with quality of life and how collective bargaining has impacted satisfaction; and

WHEREAS, it is the intention of City Council to begin working on a collective bargaining ordinance for presentation to City Council after the completion of PMO financial services from the Robert Bobb Group.

NOW, THEREFORE, BE IT RESOLVED that the Hopewell City Council hereby adopts this resolution to provide for collective bargaining by the applicable Hopewell Police Department and Department of Fire and Rescue employees, and any other public employees deemed appropriate by the Hopewell City Council, by directing County staff to draft a collective bargaining ordinance for Hopewell City Council future consideration based on parameters the Hopewell City Council will set at upcoming Hopewell City Council Work Sessions and

Hopewell City Council meetings after the completion of the audit work and PMO services performed by the Robert Bobb Group.

ADOPTED BY THE CITY COUNCIL OF THE CITY OF HOPEWELL on November 14, 2023.

Witness this signature and seal

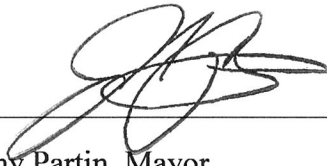

Johnny Partin, Mayor
City of Hopewell

VOTING AYE:	Vice Mayor Gore	yes
	Councilor Denton	yes
	Councilor Pelham	Yes
	Councilor Holloway	yes
	Councilor Harris	Yes

VOTING NAY:	Mayor Partin	No
	Councilor Joyner	No

ABSTAINING:

ABSENT:

ATTEST:



Brittani Williams, City Clerk
City of Hopewell





City of Hopewell, Virginia

Proposed Collective Bargaining Fiscal Impact & Bargaining Ordinance Review

**Dr. Concetta Manker, City Manager
4/17/2024**

New State Law: Va. Code §40.1-57.2, et seq.



Effective **May 1, 2021-**

Permits local governing bodies (counties, cities, towns, school boards) for the first time in the state's history to legally recognize and bargain with a **labor union** or other **employee association** as the exclusive bargaining agent of their employees and to **collectively bargain** and enter a **collective bargaining agreement**“ with respect to any matter relating to them or their employment or service,” by ordinance.

Code of Virginia: <https://law.lis.virginia.gov/vacode/title40.1/chapter4/section40.1-57.2/>



Under the New State Law...

If a locality chooses to adopt an ordinance, the new statute requires that the ordinance provide procedures for recognizing a labor union or other employee association as the employees' ***exclusive bargaining agent, authorized to enter into a legally binding bargaining contract*** governing certain employment matters.



City of Hopewell
The Proposed Ordinance

Ordinance: Content Overview



➤ *Definitions of fundamental terms [Sec. 101]*

- Collective Bargaining –[Including **scope**]
- Confidential Employee
- Employee organization
- City "employee" --[City Ordinance n/a to Schools]
- Exclusive bargaining representative
- Impasse
- Temporary, intermittent, seasonal employees
- Labor Management dispute
- Lockout
- Mediation
- Strike



Ordinance: Content Overview

Ineligible to Bargain: [Sec. 101] [§ 40.1-57.2]

- Elected/appointed officials and members of boards, commissions, state employees working at local level
- Employees of "Constitutional Officers"
- Managerial employees
- Supervisory employees
- Confidential employees (Attorney and Human Relations)
- Temporary, Intermittent, Probationary employees
- Interns, Volunteers

Code of Virginia: <https://law.lis.virginia.gov/vacode/title40.1/chapter4/#article2-1/>

Meet and Confer



The City Manager or his/her designee shall, upon request, meet and confer with employees who supervise members of a certified bargaining unit who are themselves are ineligible to bargain collectively regarding matters within the scope of collective bargaining under this ordinance, with the specific intent to address salary compression, as commonly defined or understood, resulting from collective bargaining with certified employees.



City of Hopewell

Infrastructure, Framework & Cost Requirements



City Demographics - Snapshot

Population	22,962
Persons under 18 years	5,878 (25.6%)
Median Household income	\$50,661
Health (disability, under age 65)	2,686 (11.7%)
*House Roof Tops	9,000 Homes
*Individual Property Ownership (homes, companies)	6,477
Persons in poverty.	4,890 (21.3%)
*Subsidized and Unsubsidized housing	2,000 residents (8.7%)

<https://www.census.gov/quickfacts/fact/table/hopewellcityvirginia/PST045222>

* Data collected from the City of Hopewell

Staffing Requirements



Current Staff	New Internal Staff	New External Staff
HR Director	<u>Deputy City Attorney</u> (handle increase volume of grievances)	<u>Labor Relations Administrator (LRA)</u> – Overseeing elections, determining unresolved issues. Refer to section 106 of Collective Bargaining Ordinance
HR Administrator	<u>Employee & Labor Relation Manager</u> (provides expertise in policy, labor contracts, addressing employee relation issues)	<u>Attorney Firm</u> - Specialized in Collective Bargaining (Retainer or hourly services as needed to administers the collective bargaining process).
HR Generalist (Admin Staff)	<u>Labor Relation Specialist</u> (research, interprets and administer labor contracts communicate policies).	
Risk Manager (PT)	<u>Financial Budgeting and Reporting Analyst</u> (analyzing, preparing and reporting budgeting for all bargaining units)	
City Attorney		
Paralegal		



Cost of Administration

Staffing	Salary	Benefits	Total Cost	Description	Details
Deputy City Attorney	\$120,000	\$45,692	\$165,692	Salary and Benefits	Salary range in Virginia \$103,916 – \$142,896.00
Labor Relations Officer	\$99,000	\$40,786	\$139,786	Salary and Benefits	Salary range in Virginia \$86,503.82-\$152,2030.52
Labor Relations Specialist	\$70,000	\$34,011	\$104,011	Salary and Benefits	Salary range in Virginia \$60,477-\$80,488
Financial Budgeting and Reporting Analyst	\$86,702	\$37,913	\$124,615	Salary and Benefits	Salary range in Virginia \$86,000-\$130,000
Labor Administrator (LRA)	\$150,000		\$150,000	\$2,500/ day	Costs assumes 60/days
Attorney Firm – Labor Specialty	\$620,000-\$850,000		\$850,000	\$310-\$425/hour	Cost assumes 2000/hours

Salary: <http://www.governmentjobs.gov>



Cost of Administration.

Mediation, Dispute Resolution and Factfinding –
Variable Costs

Dispute Resolution	Cost	Description
Mediation (counseling)	50/50 Cost share	Average cost is \$1,200 - \$2,000/day
Impasse (parties that cannot agree)	50/50 Cost share	
Arbitration (impose a final contract without parties agreeing)	50/50 Cost share	Average cost is \$6,500 - \$8,000

The City of Hopewell estimates administrative cost for collective bargaining will cost between **\$1,304,104** to **\$1,534,104** to the budget yearly. This estimate is conservative, because variable costs are unable to be captured.

Rating Impact of Collective Bargaining



- ▶ James Sanderson, Senior Vice President – Davenport
 - ▶ Rating Impact of Collective Bargaining (see attached letter)

The City's financial advisor Davenport & Company LLC was asked about the impact on ratings of collective bargaining and Davenport reported back after consulting with current and former bond rating agency analysts that "collective bargaining is not a credit positive", that it would be considered a "constraining factor" in the determination of a jurisdiction's bond rating, and would be "definitely more limiting on the expenditure side and creates pressures that were not there before".



Shared Lessons Learned

- ▶ **Do not implement all bargaining units at once.**
 - ▶ Consider a phased approach to help to manage administrative costs.

- ▶ **Complete Fiscal Health and Salary Class & Compensation study before implementation.**
 - ▶ This will help organization know where salaries should be prior to bargaining, because bargaining units will come with their own studies.
 - ▶ Fiscal Health study will determine if your municipality has the fiscal strength to handle ongoing administrative costs, legal costs, compounding yearly salaries and all other forms of monetary compensation such as, bonus, merit raises, overtime, cost of living (COLA) raises, signing bonuses, shift differential pay, tuition reimbursement pay, 401k match options, retention bonuses, relocation stipend, professional development stipend.
 - ▶ Consider a compensation step plan for all employees. A step-rate compensation structure are easy to understand and communicate. Its best for recruitment, retention and pay equity. And it help Finance manage cost effectively.

Shared Lesson Learned Continued.....

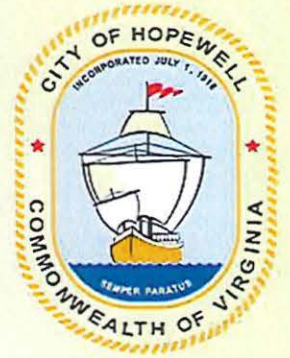

- ▶ **Educate the Public and Workforce before and after Collective Bargaining Ordinance Approval.**
 - ▶ The public should have buy-in prior to collective bargaining. Often times taxes will have to be increased to support ongoing and compounding bargaining costs.
 - ▶ Educate the workforce regarding collective bargaining to avoid employee resentment between departments, and tension between department heads and the feeling of "loss of power" from the executive staff.
- **Ensure that councilors understand the impact of collective bargaining.**
 - While Council retains the legal authority to not fund a collective bargaining agreement, there will be significant pressure on a Council to continue to fund collective bargaining agreements once they are approved.

Lessons Learned Continued.....

- After making a good faith pledge, there will be significant employee and union pressure to maintain it, and it will be politically very difficult for a governing body to reverse that pledge, even in the case of an economic emergency.
- **Ensure that your HR Manual is updated with current rules and policies.**



Recommendations

- **Meet and Confer Process:** In a state where an employer is not legally required to collectively bargain with a union and chooses not to, they may discuss issues and solicit input.
 - **Purpose:** The purpose of meet and confer rules is to save the parties time and money and increase judicial economy by encouraging parties to resolve issues without the need for invention.
- **Complete a Salary and Compensation Study**
- **Create a Resolution to revisit Collective Bargaining in Fiscal Year 2027.**



Recommendations Continued...



▪ Create a Resolution to revisit Collective Bargaining in Fiscal Year 2027.

- ❖ Collective Bargaining is not recommended as this time because of the fiscal distress posture of the City.
- ❖ Collective Bargaining would require additional tax increases on citizens for yearly compounding administrative costs.
- ❖ It is the Government Finance Officers Association (GFOA) recommendation that municipalities have an economic reserve of 16.9% of total annual budget. The City of Hopewell has not reached this goal; therefore, additional significant cost is fiscally risky.

ORDINANCE NO. _____

TO AMEND CHAPTER 2 OF THE CITY CODE (ADMINISTRATION) OF HOPEWELL, VIRGINIA, TO ADD A NEW ARTICLE III AUTHORIZING COLLECTIVE BARGAINING WITH LABOR UNIONS OR OTHER EMPLOYEE ASSOCIATION

WHEREAS the Virginia General Assembly enacted Sec 40.1-572 of the Virginia Code to expressly authorize the City and other local government, upon adoption of a local ordinance to recognize labor unions or other employee associations as bargaining agents for public officer or employee, subject to the provisions and limitation set forth with said statute; and

WHEREAS within this ordinance, City Council desires to provide procedures for the certification and decertification of exclusive bargaining representatives, including reasonable public notice and opportunity for labor organization to intervene in the process for designating and exclusive representative of bargaining unity, and to set forth procedures and parameters within which collective bargaining contracts may be negotiated and administered within the City government, consistent with the City Charter and the general laws of the Commonwealth of Virginia; NOW, THEREFORE,

BE IT ORDAINED BY THE CITY COUNCIL OF THE CITY OF HOPEWELL, VIRGINIA THAT:

Section 1: That the Code of the City of Hopewell, Virginia, as amended, be, and the same hereby is, add the new Article III (Collective Bargaining) as follows:

CHAPTER 2-ADMINISTRATION

ARTICLE III - COLLECTIVE BARGAINING

Sec. 100 - Statement of Policy / Purpose

It is the public policy of the City of Hopewell and the purpose of this article to promote orderly and constructive relationships between the city and its employees subject, however, to the supreme right of the citizens of the city that their government honor guarantees for their health, safety, welfare, and the uninterrupted operations and functions of government. Because unresolved disputes between the city and its employees are detrimental to the public and to city employees, adequate means must be established for their speedy and effective resolution. Within the limitations required by the greater public interest and recognizing that amicable relationships are required between the city and its employees, the City Council has determined that the overall policies set forth here may best be accomplished by (1) granting to city employees the right to organize and choose their representatives freely; (2) permitting the city to negotiate and bargain in good faith with employee organizations representing city employees and to enter into written agreements evidencing the result of such bargaining; and (3) establishing procedures to provide for the protection of the rights of the city, city employees and the public at large.

The council establishes this policy with the intent that city employees enjoy the right to bargain collectively within parameters that promote a government that provides ethical, effective and efficient services that are responsive to the community and focused on improving quality of life through the services of well-qualified staff who value and work to actively promote policies to

advance all things reasonably necessary to achieve organizational excellence, while at all times elevating principles of cooperation, ethics, honesty, initiative, and learning,

City Council intends to initiate this policy upon a good faith finding that the city is in good fiscal health in order to initiate the adoption of an ordinance to permit collective bargaining. City Council intends to request and be provided with a fiscal impact study to determine the appropriate time to initiate the collective bargaining process.

Sec. 101 - Definitions.

As used in *this* article, the following terms shall have the meanings ascribed to them in this section:

Administrative employee means an employee whose primary duty is the performance of office or non-manual work directly related to or in furtherance of the management or general business operations and services of the city.

Arbitration means the procedure by which the city and an exclusive bargaining representative, when involved in a labor-management dispute, as defined in this article, submit their differences to a third party for a final and binding decision subject to the provisions of this article.

Benefits mean all forms of non-wage compensation.

City means the City of Hopewell acting through its City Manager or its designee.

Collective Bargaining means to performance mutual obligation of the City, by its representatives. The exclusive bargaining representative of employees in an appropriate bargaining unit to meet and negotiate in good faith at reasonable times and places, with the good faith intention of reaching an agreement and remaining in effect until superseded by a new agreement, regarding terms and conditions of employment including terms and conditions of employment, including wages, salaries, and other forms of monetary compensation. Any agreement reached by collective bargaining shall be subject to appropriation of funds by the City Council.

A *collective bargaining agreement* is the written legal contract between the City and an exclusive bargaining agent representing the employees in a bargaining unit authorized by this entity and resulting from collective bargaining as defined in this section.

Confidential employee means any employee who works in or for:

- (1) the office of the City Council;
- (2) the office of the City Manager;
- (3) the office of the City Attorney;
- (4) the office of the City Clerk;
- (5) the Department of Human Resources or other department or position in which the employee has authorized access to confidential city personnel files;

(6) the Office of Management and Budget; or

(7) is a secretary, administrative assistant, management analyst, or any other position, wherever assigned and however, those titles may be changed from time to time, with authorized access to confidential information pertaining to City budgetary and fiscal data relevant to subjects within the scope of collective bargaining as set forth in this article.

Employee means any employee of the City, except it does not include anyone who is:

(1) an employee of the courts or of any local constitutional officer, i.e., officers elected pursuant to Article VII, Section 4 of the Constitution of Virginia;

(2) a confidential employee, as defined in this section;

(3) a managerial employee, as defined in this section;

(4) a supervisor, as defined in this section;

(5) an intermittent, temporary or seasonal employee, as defined in this section;

(6) an intern or volunteer;

(7) a member of a board or commission, or other appointee of any public body as defined by state law; or

(8) an attorney whose responsibilities include providing legal advice to the City or performing legal research for the City as a client.

Employee organization means an organization in which employees participate, and that exists for the purpose, in whole or in part, of representing employees in collective bargaining concerning labor disputes, wages, hours, and other terms and conditions of employment.

Exclusive bargaining representative and *exclusive bargaining agent* mean the employee organization recognized by the City as the only organization to bargain collectively for all employees in a bargaining unit (as defined in section 105),

Impasse means the failure of the City and an exclusive bargaining representative to reach agreement in the course of collective bargaining negotiations.

Intermittent employee means irregular or variably recurring, hourly employment that is less than full time in any calendar year.

Labor-management dispute means a difference of position as between the City and the exclusive bargaining agent concerning administration or interpretation of the collective bargaining agreement between them; negotiability disputes; action challenged as a prohibited practice under Sec. 115; and questions of eligibility of disputes for resolution by arbitration. It shall not include

an individual grievance as defined by Virginia Code Section 15.2-1507(A)(1).

Lockout means any action taken by the City intended to interrupt or prevent the continuity of work properly and usually performed by employees for the purpose of coercing or intimidating employees in the exercise of their rights conferred by this article or influencing their exclusive bargaining agents' positions in collective bargaining contract negotiations.

Managerial employee means any individual who:

- (1) has responsibility for a unit or sub-unit of a division of an agency or department;
- (2) participates in the formulation of policy;
- (3) is significantly engaged in executive or management functions;
- (4) is charged with the responsibility of directing the implementation of management policies, procedures, or practices; or
- (5) is involved in administration of collective bargaining agreements or human resources or personnel decisions, including, but not limited to, staffing, reductions-in force/layoffs, reorganizations, hiring, discipline, evaluations, pay, assignments, transfers, promotions or demotions.

Mediation means an effort by a neutral, third-party factfinder chosen under the terms of this article to assist confidentially in resolving an impasse, as defined in this section, arising in the course of collective bargaining between the City and the exclusive bargaining agent of a bargaining unit, or the first step prior to arbitration of a labor-management dispute other than a prohibited practice claim or charge.

Professional employee means an employee exempt from the Fair Labor Standards Act and whose primary duty is the performance of work;

- (1) Requiring knowledge of an advanced type in a field of science or learning customarily acquired by a prolonged course of specialized intellectual instruction; or
- (2) Requiring invention, imagination, originality, or talent in a recognized field of artistic or creative endeavor.

Seasonal employee means an employee who is hired into a position for which the customary annual employment is four (4) months or less and for which the period of employment begins each calendar year in approximately the same part of the year, such as summer or winter, for reasons related to work demands that arise during those parts of the year.

Supervisor means any individual who customarily and regularly devotes a majority of work time to supervision of two or more employees and has authority to hire, transfer, suspend, layoff, recall, promote, demote, discharge, reward or discipline other employees, or adjust grievances, or effectively to recommend any such actions. With respect to the Fire Department, "supervisor" includes all personnel at the rank of battalion chief or above. With respect to the Police Detachment,

"supervisor" includes all personnel at the rank of deputy chief or above. The City Manager or City Manager's designee shall meet and confer with Police and Fire supervisor's ineligible to bargain collectively regarding matters within the scope of collective bargaining as specified in this article with the specific intent to address salary compression, as commonly defined or understood, resulting from collective bargaining with eligible Police and Fire uniformed employees.

Strike means action of an employee of the City in concert with two or more other such employees for the purpose of obstructing, impeding, or suspending any activity or operation of the City (see Virginia Code § 40.1-55) or inducing, influencing, or coercing a change in the conditions, compensation, rights, privileges, or obligations of City employment.

Technical employee means an individual whose work requires a combination of basic scientific or technical knowledge and manual skill that can be obtained through specialized postsecondary school education or through equivalent on-the-job training.

Temporary employee means an individual who is employed for not more than 180 days in a 24-month period.

Sec. 102 - Authorized Subjects of Collective Bargaining

(a) The following matters are authorized subjects of collective bargaining;

1. wages, salaries, and other monetary compensation;
2. workplace conditions.

(b) The following matters shall not be subject to negotiation:

1. the provider of the City's existing retirement plan or any decision to replace any or all such plans with the retirement of the Virginia Retirement System,
2. benefits established and administered in accordance with the Code of Virginia over which the City does not have discretion or control,
3. insurance benefit options, insurance plan providers, employer subsidies for insurance provided to individuals who are neither active employees nor their covered dependents, including retirees and/or survivors,
4. other matters controlled or preempted by federal or state constitutional provision, law, rule, or regulation, or by the City Charter, such as:
 - Matters pertaining to the composition, duties, or powers of any civilian review board applicable to police officers, or to any decision rendered by such a board.
 - Matters governed by Code of Virginia, § 9.1-300 et seq.
5. Matters affecting the City's right to take disciplinary actions up to and including termination for probationary employees, as that term is used in the City's personnel regulations;

6. Matters affecting the City's rights to establish policies or practices to respond to emergency situations; and
7. Provision, prohibited by state law, that restricts the City Council's authority to establish the budget or appropriate funds in its discretions
8. Any plans to replace the City's Human Resource policies.

Sec. 103 - Employee Rights

- (a) Employees shall have the right to organize, form, join, assist, and pay dues or contributions to employee organizations, to bargain collectively through an exclusive bargaining representative of their own choosing, and to engage in other concerted activities for the purpose of collective bargaining or other mutual aid and protection insofar as such activity is not inconsistent with this article or prohibited by any other applicable law.
- (b) A collectively bargained agreement provision that violates the rights of employees set forth in this section shall be void. A collectively bargained agreement provision that establishes a time period for the exercise of an employee right set forth in this section shall not violate this section. The City and each employee organization will refrain from any intimidation, coercion, or harassment of employees who choose to exercise their rights under this article.
- (c) Employees shall have the right to hold informal conversations and interactions with one another to discuss workplace and employee organization issues while on duty, provided that such conversations do not interfere with the employee's job duties. Employee organizations shall not hold formal meetings that interfere with the work time of employees, except as provided for in this article or in a collective bargaining agreement.
- (d) Employees are not prohibited from, and shall not be penalized or retaliated against for using City electronic mail telephone, facsimile transmission, or other communication systems owned by the City to discuss employee organization business or activities or employee organizing activities; however, the City remains the owner of such communication systems. The City's access to or disclosure of emails, voicemails, or other communications when required by law, for the use in litigation or administrative hearings, for use in investigations, or for other proper business or governmental purposes shall not be considered a prohibited practice.
- (e) Employee organizations have the right to meet with bargaining unit employees on the premises of the City in designated spaces during times when the employees are on break or in a non-duty status. This section shall not be applied or interpreted in a manner that prohibits casual nondisruptive conversation among employees in the workplace.
- (f) Employees also shall have the right to refrain from any or all such activities

Sec. 104 - City's Rights and Authority.

- (a) This ordinance shall not be deemed in any way to limit or diminish the authority of the City Council and the City Manager to fully manage and direct the operations and activities of the City to the extent authorized and permitted by law. Thus, to the extent not inconsistent with a collective bargaining agreement, the City Council and the City Manager retains

exclusive rights including, but not limited to, the right:

- (1) To determine the organization of City government and the purpose and mission of its constituent agencies, and to add, delete, modify, or suspend programs, functions, and units of government as the City determines to be necessary and appropriate;
- (2) to determine the type and scope of work to be performed by City employees, and the manner in which services are to be provided;
- (3) to direct the work of employees and determine the number of employees to perform any work or service;
- (4) to hire, promote, transfer, assign, retain, classify and schedule all employees and to suspend, demote, discharge, or take other disciplinary action against employees in accordance with applicable law and regulations;
- (5) to determine and change the number of positions and/or the appointment type (full time, part time, etc.) for such positions;
- (6) to relieve employees from duties by layoff or other reduction-in-force due to lack of work, changed working conditions/requirements, budget limitations or for other reasons in the City's reasonable business judgment and not prohibited by law;
- (7) to introduce new, or different services, methods, equipment, or facilities;
- (8) to contract for, expand, reduce, sell, transfer, convey, eliminate or change in any way the operations of general government, as well as any department, office or part thereof;
- (9) to establish and change standards of behavior or performance, staffing levels, job qualifications and job descriptions;
- (10) to determine the kind, type, location and use of City-owned equipment or facilities, provided that the City does not require use or operation of unsafe equipment or the unsafe operation of equipment;
- (11) to determine its tax levies, revenue generation methods, budget, and appropriation;
- (12) to require enhanced security measures to protect City facilities, infrastructure, personnel and the public;
- (13) to retain the ability and authority to continue to implement the current administrative regulation in the management of probationary employees.
- (14) to take whatever actions may be necessary to carry out the City's mission during a state of emergency as defined in Code of Virginia §44.146.16 affecting the City or a declaration of local emergency as defined in Code of Virginia §44.146.16, or during such other emergency operations as may be deemed necessary by the City Manager or his/her designee;

(15) to make and implement systems for awarding outstanding service increments, extraordinary performance awards, other merit awards, and recognizing employee recognition and service (including hiring and bonuses);

(16) to introduce new or improved technology, research, development, and service;

(17) to determine matters related to the administration of pay and benefits which are not directly related to monetary compensation or benefits;

(18) to issue and enforce rules, policies, and regulations necessary to carry out these and all other managerial function which are not inconsistent with this ordinance, a collective bargaining agreement, or federal or state law; and

(19) to take any other action necessarily to fulfill the duties and responsibilities granted to the City Manager of the Charter of the City of Hopewell, Virginia.

(b) In accordance with Code of Virginia §40.1-57.2 and other applicable law, nothing in this section, any provision of this article or the terms of any collective bargaining agreement shall impair or restrict the authority of the City Council to establish its budget and appropriate funds in its discretion.

(c) No provision of this ordinance shall act to interfere with or impair the free speech and association rights of the City Manager or the members of the City Council. No prohibited practice charge may be brought against the City, the City Manager, or any City Council member because of such individual's or City's collective exercise of the right of free speech and association so long as such expression or speech contains no threat or reprisal or promise of benefit.

(d) This section does not limit the discretion of the City to voluntarily discuss with the exclusive representation any matter concerning the City's exercise of any right specified in this section. If any matter is discussed, it does not become a subject of collective bargaining unless reduced to writing and signed by both parties

Sec. 105 - Bargaining Units.

During the first three years after adoption and appropriation, collective bargaining units may only negotiate employee salaries to exclude; health benefits, short term disability; long term disability, life insurance coverage, step pay plan, cost of living increases; worker's compensation benefits and any other forms of additional compensation and benefits. The City shall recognize only the following bargaining units for the purposes of collective bargaining:

(a) Police: The police employees' bargaining unit shall consist of all sworn employees of the police department, except those excluded by definition in Sec. 101;

(b) Fire and Emergency Medical Service: The fire and emergency medical services employees' bargaining unit shall consist of the uniformed fire employees, including fire marshals, except those excluded by definition in Sec. 101;

- (c) Labor & Trades; Those eligible classes of employees associated with maintenance and skilled crafts, i.e., job classes of workers performing duties that result directly in the comfort and convenience of the general public, or contribute to the maintenance of capital assets, land and infrastructure of the City, except those excluded by definition in Sec. 101.
- (d) Professional: a unit consisting of non-supervisory and non-managerial employees within the definition of "professional employee" as set forth in Sec. 101.
- (e) Administrative and Technical: a unit consisting of regular full time and part-time employees of the City who are administrative employees or technical employees or who are within the definition of "administrative employee" or who perform office support work and who are not confidential employees excluded from collective bargaining within the definition set forth in Sec. 101.
- (f) The City Manager or his/her designee shall, upon request, meet and confer with employees who supervise members of a certified bargaining unit who are themselves are ineligible to bargain collectively regarding matters within the scope of collective bargaining under this ordinance, with specific intent to address salary compression as commonly defined or understood, resulting from collective bargaining with certified employees

Sec. 106 - Labor Relations Administrator.

- (a) A labor relations administrator (LRA or the administrator) shall be appointed by the city manager in the manner set forth in subsection (c) of this section to effectively administer this article as it governs exclusive bargaining representative selection, certification and decertification procedures, labor-management disputes as defined in section 101, and choice of mediator(s) and/or arbitrator(s) as needs arise under this article or under any collective bargaining agreement.
- (b) Upon the adoption of a collective bargaining ordinance by City Council, the City Manager has 90 days to post the job announcement for the LRA position.
- (c) An LRA position may be in place 60 days prior to the onset of contract negotiations.
- (d) The administrator must be experienced as a neutral in the field of labor relations, and must not be a person who, because of vocation, employment, or affiliation, can be categorized as a representative of the interest of the City or any employee organization, including an exclusive bargaining agent for a bargaining unit permitted under this article.
- (e) Subject to confirmation by the City Council, the City Manager shall appoint the labor relations administrator who shall be selected for a 4-year term from no more than 3 (three) nominees jointly agreed upon and submitted by: (i) representatives of those employee organizations that have notified the City manager or City manager's designee of their interest in representing bargaining units permitted by this article, if no exclusive bargaining agents have been recognized at the time the selection process begins, or (ii) by the exclusive bargaining agents of the bargaining units permitted by this article, and (iii) an equal number of designees of the City Manager. If the Council does not confirm the appointment on the recommendation of the City Manager, an appointment must be made from a new agreed list of 3 (three) nominees

compiled in the same manner.

- (f) The administrator's services shall be subject to termination by mutual agreement of the City Manager and a majority of the exclusive bargaining agents of the bargaining units permitted by this article, and with council approval.
- (g) If the administrator dies, resigns, becomes disabled, or otherwise becomes unable or ineligible to continue to serve within six (6) months of initial appointment, the City manager shall appoint a new administrator from the list from which that administrator was selected, subject to council confirmation, to serve the remainder of the previous administrator's term. Otherwise, the administrator vacancy shall be filled as provided in subsection (c).
- (h) An LRA appointed under this section may be reappointed as provided in subsection (c).
- (i) The terms of payment for the services of the administrator shall be paid as specified by the contract with the City.

The Labor Relation Administrator (LRA) shall:

- (1) hold and conduct elections for certification or decertification pursuant to the provisions of this article and issue the certification or decertification or cause these actions to occur.
- (2) request from the City or an employee organization, and the City or such organization shall provide, any relevant assistance, service, and data that will enable the administrator to properly carry out duties under this article.
- (3) hold hearings and make inquiries, administer oaths and affirmations, examine witnesses and documents, take testimony, and receive evidence, and compel by issuance of subpoenas the attendance of witnesses and the production of relevant documents in proceedings within the responsibility of the administrator under this article.
- (4) investigate and attempt to resolve or settle, as provided in Section 113 - Mediation and Arbitration, charges of either the City or an employee organization engaging in prohibited practices as defined in this article. However, if the City and a certified representative have negotiated a labor management dispute resolution procedure, the administrator must defer to that procedure to resolve any dispute that properly may be submitted to the procedure, absent a showing that the deferral results in the application of principles contrary to this article. The administrator must defer to state procedures in any matter governed by the Law-Enforcement Officers' or Firefighters and Emergency Medical Technicians' Bill of Rights set forth in the Virginia Code, or to any other such procedure dictated by state statute.
- (5) determine unresolved issues of employee inclusion in or exclusion from the bargaining units permitted under this article.
- (6) obtain any necessary support services and make necessary expenditures in the

performance of duties, subject to appropriation.

(7) determine any issue regarding the negotiability of any collective bargaining proposal.

(8) Exercise any other powers and perform any other duties and functions specified in this article of an administrative nature.

Sec. 107 - Recognition of Exclusive Bargaining Agent.

A bargaining agent shall be the exclusive representative of all employees in an appropriate bargaining unit described in Section 105 if the employee organization is selected by a majority of the employees voting in an appropriate bargaining unit in an election conducted pursuant to this article and rules and procedures adopted by the LRA.

(a) In the event that more than one (1) employee organization files a request for recognition or for election within ten (10) calendar days after a first request for recognition or for election has been filed, an election to select an exclusive bargaining agent shall be held under the rules and procedures adopted by the LRA. If an employee organization receives a majority of the votes cast by the employees voting in an appropriate bargaining unit, it shall be recognized by the City as the exclusive bargaining agent, provided, however, that the City manager/designee or an employee organization may file exceptions to the election with the LRA alleging that there has been misconduct which has affected the outcome of the election, and the City need not recognize the employee organization pending the resolution of a duly process to review those exceptions. Any cost of such election shall be shared equally by the parties involved.

(b) "Administratively acceptable evidence" to support a petition for certification within the meaning of Virginia Code §40J-57.2(C), for certification by representation election, or for decertification (see Section 109) may consist of a combination of membership cards or a membership roster, evidence of dues payment, or other evidence of bargaining unit employees' desire to be represented by an employee organization for collective bargaining purposes. An authorization that satisfies the Uniform Electronic Transactions Act (Virginia Code § 59.1-479 et seq.) including, without limitation, electronic authorizations and voice authorizations, shall be valid for employees' authorization for representation for purposes of a petition filed by a labor organization for exclusive representation. The determination by the LRA (or of the City manager or manager's designee in the absence of the LRA) of the sufficiency of a showing of majority support or for a representation election shall not be subject to challenge by any person or employee organization or by the City.

Sec. 108 - Request for Election.

(a) An employee organization may request an election be held by submitting a petition for an election to the LRA who shall notify the City manager pursuant to its rules and procedures. The petition must represent a showing of interest by at least thirty (30) percent of the employees in a bargaining unit permitted by this article.

(b) Any additional interested employee organization must submit a petition of intervention to the LRA, which must be accompanied by a showing of interest by thirty (30) percent of the employees in the appropriate bargaining unit within ten (10) days of notice of the

pending election.

- (c) An election under this article shall be held within forty-five (45) calendar days after written notice to all parties of the determination by the LRA of a valid petition for election in accordance with guidelines established by the LRA. If an employee organization receives a majority of the valid ballots cast by the employees in a permitted bargaining unit, it shall be recognized by the City as the exclusive bargaining agent, provided unless and until the LRA certifies a different organization or otherwise decertifies the agent in accordance with rules set forth in this section. In an election in which none of the choices on the ballot receives a majority, a runoff election shall be conducted in which the ballot shall provide for a selection between the two choices or parties receiving the highest and second highest number of ballots cast in the election. However, the City or the employee organization may file exceptions with the LRA in accordance with its rules, and the City need not recognize the employee organization pending the resolution of any process to review those exceptions.
- (d) Nothing in this article shall require or permit an election in any bargaining unit within twelve (12) months after a previous election has resulted in the recognition of an exclusive bargaining representative or a determination that the employees choose no representation in such bargaining unit.
- (e) No party shall have an advantage over the other in gaining access to employees during organizational or representation campaign activity. Unless there is a recognized bargaining representative, interested employee organizations will receive the same access to bargaining unit employees as is currently provided to outside organizations under City policies and practices for facility use and attendance at any meeting of such organizations under these circumstances is voluntary and open to all prospective bargaining unit employees.

Sec. 109 - Decertification/Withdrawal of Recognition

- (a) Recognition of an employee organization as the exclusive bargaining agent for a bargaining unit permitted by this article shall continue only so long as such organization satisfies the criteria of this article.
- (b) If a petition for decertification of a recognized exclusive bargaining agent is presented to the LRA showing that at least fifty (50) percent of the employees in the bargaining unit no longer want the employee organization to be their bargaining agent, then the LRA shall hold an election pursuant to section 108 of this article.
- (c) A petition for decertification of a recognized exclusive collective bargaining agent in an appropriate unit may be filed in a thirty-day (30) period between the one hundred eightieth (180th) and one hundred fiftieth (150th) day prior to expiration of any existing collective bargaining agreement for that bargaining unit or any time after that collective bargaining agreement has expired.
- (d) For a period of one (1) year following recognition or certification of an exclusive bargaining agent, no decertification petitions may be filed.
- (e) The employee organization no longer shall be recognized as the exclusive bargaining agent

of the employees in the bargaining unit if a majority of the employees in the appropriate bargaining unit vote in the decertification election to no longer be represented by the employee organization and a final outcome of that election has been certified by the LRA.

Sec. 110 - Rights Accompanying Exclusive Representation.

Any employee organization recognized as the bargaining agent for employees in an appropriate bargaining unit shall have the following rights:

- (a) To speak on behalf of all members of the unit and shall be responsible for representing the interests of all members of the bargaining unit without discrimination and without regard to employee organization membership.
- (b) To meet at reasonable times and places to engage in good faith collective bargaining on matters that, under this article, may be the subject of collective bargaining, in an effort to reach an agreement, subject to the tentative approval of the City Manager or the City Manager's designee with responsibility for the employees in the bargaining unit.
- (c) To meet with bargaining unit employees on the premises of the City in non-secure areas during times when the employees are on break or in a non-duty status. Any other employee organization that has submitted a petition and established a valid question concerning representation of the bargaining unit shall also be permitted to meet with bargaining unit employees with the same limitations. This subsection shall not restrict an exclusive bargaining agent and the City from negotiating for greater access to employees by the exclusive bargaining agent as provision of a collective bargaining agreement.
- (d) To receive quarterly a list of all bargaining unit employees, as well as to be informed of all new hires within ten (10) days.
- (e) To meet with newly hired employees, without charge to the pay or leave time of any of the employees for a maximum of 30 minutes, within 30 calendar days from the date of hire, during new employee orientations, or if the City fails to conduct new employee orientation, at individual or group meetings.
- (f) To use City communications systems to communicate with employees regarding collective bargaining, the administration of collective bargaining agreements, the investigation of grievances, other workplace related complaints and issues, and internal union matters involving the governance or business of the exclusive bargaining agent.
- (g) To be the only labor organization eligible to receive from the City amounts deducted from the pay of employees as authorized by written assignment of the employees, for the payment of regular and periodic dues to the exclusive bargaining agent, unless two exclusive bargaining agents of City employees agree that they can both receive deductions from the same employee. Any such authorization may be revoked in accordance with the terms of the authorization which shall provide a period of irrevocability of not more than one year. An authorization that satisfies the Uniform Electronic Transactions Act (Virginia Code § 59.1-479 et seq.), including, without limitation, electronic authorizations and voice authorizations, shall be valid for employees' authorizations for payroll deductions and authorization for representation for purposes of a petition filed by an employee organization

for exclusive representation.

- (h) To be represented at any formal discussion between one or more representatives of the City and one or more employees in the bargaining unit or their representatives concerning (1) any matter that is within the scope of collective bargaining as set forth in the definition of collective bargaining (see Section 101); or (2) any examination of bargaining unit employees by a representative of the City in connection with an investigation if the employee reasonably believes that the examination involves matters covered by any collective bargaining agreement then in effect, and the employee requests representation. The City shall inform the employee that he employee has a right to union representation prior to any such discussion or interview, and the employee shall have a right to request union representation before proceeding with the discussion or interview.
- (i) Notwithstanding any other provision in this section, an individual employee may present a personal complaint, concern or question at any time to the City without the intervention of an employee organization, provided that any such organization that is recognized by the City as the exclusive bargaining agent for the bargaining unit in which the employee is a member is afforded an effective opportunity to be present and to offer its view at any meetings held to adjust the matter and that any adjustment made shall not be inconsistent with the terms of any applicable collective bargaining agreement. Such employee or employees who utilize this avenue of presenting personal complaints, concerns or questions to the City shall not do so under the name, or by representation, of an employee organization.
- (j) The requirements set forth in this section establish the minimum requirements for access to and communication with bargaining unit employees by an exclusive bargaining representative. These requirements shall not prevent the City and the exclusive bargaining representative from bargaining for greater access to or communication with employees.

Sec. 111 - Good Faith Bargaining.

- (a) A written request for bargaining must be submitted by the exclusive bargaining agent to the City manager or the manager 's designee no later than March 1, and negotiations must begin by April 1 and conclude by September 1 of any year where an agreement is sought to be effective at the beginning of the next fiscal year, in order to accommodate the City budget process. Failure of the parties to reach agreement by September shall constitute impasse and trigger impasse resolution procedures under this article.
- (b) Nothing in this article requires either party to make any concessions or agree to the other party's proposals.
- (c) Good faith bargaining shall not include submission of or a response to a proposal that;
 - (1) Violates the rights of employees as set forth in 102; or

- (2) Impairs, restricts, or delegates the authority of the City as set forth in Section 103(b).
- (d) The City manager shall designate or appoint the City's representative(s) in collective bargaining negotiations in the manager's sole discretion.
- (e) If an employee organization serves as the exclusive representative of more than one bargaining unit, it shall consolidate its bargaining with the City and negotiate a common master agreement on all matters not unique to particular bargaining unit.

Sec. 112 - Approval of Tentative Agreement

- (a) When an exclusive bargaining agent and the City reach a tentative agreement, they shall reduce it to writing and execute it signifying the approval of the bargaining agent and the City bargaining representative. No agreement shall be effective or enforceable:
 - (1) unless a fiscal impact study(ies) of the tentative agreement provisions, conducted as bargaining proceeds, has been prepared by the City Office of Management and Budget; and
 - (2) the City Council specifies by resolution no later than the last day of December its good faith commitment to appropriate funding necessary for the City to meet obligations under the tentative agreement as set forth in the fiscal impact study provided for in this section, with the understanding that any such resolution remains subject to actual appropriation. If the Council does not resolve to fund any provision(s) of the tentative agreement requiring appropriation or other Council action, the resolution shall state the reason(s), and the City Manager and the exclusive bargaining agent must re-open negotiations on those provisions only, with the understanding that any such negotiations shall be scheduled as promptly as possible with the good faith objective to negotiate provisions that may be acceptable to the Council for its consideration within the City's budget approval schedule. Upon presentation to the Council of any tentative agreement re-negotiated under this subsection, the Council shall consider and specify by resolution as soon as practicable its good faith commitment to appropriate funding necessary for the City to meet obligations under the tentative agreement, or its intention not to do so, with the understanding that any such resolution remains subject to actual appropriation; and
 - (3) the tentative agreement is approved by:
 - a. The City Manager or City Manager's designee with supervisory responsibility for the employees in the bargaining unit, as evidenced by signature, which may be an electronic signature made in accordance with applicable state law; and
 - b. The exclusive representative by ratification of the tentative agreement in accordance with the bargaining representative's governing procedures, and evidenced by the signature of an authorized agent which may be an

electronic signature made in accordance with applicable state law.

- (b) A written agreement shall be contrary to public policy and therefore shall not bind the parties or be enforceable by either party to the extent that it is not the result of good faith bargaining as defined in Section 111.

Sec. 113 - Mediation, Dispute Resolution, and Factfinding.

(a) Mediation.

- (1) Labor-Management Disputes: The City and an exclusive bargaining agent shall discuss the feasibility of resolution of labor-management disputes informally by discussion between the parties' designees before resort to formal mediation or arbitration. Failure to actually engage in such informal resolution prior to submitting a labor-management dispute or prohibited practice claim for mediation or arbitration shall not be a ground for dismissal of a claim under this article. In the event that the City and the bargaining agent are unable to informally resolve a labor-management dispute if and when engaged, either party or the parties jointly may submit the dispute to the LRA for mediation or arbitration, if applicable, pursuant to procedures instituted by the LRA.
- (2) Impasse: In the event that the City and the bargaining agent are unable to reach a collective bargaining agreement within one hundred twenty (120) days after their first meeting or October 5, whichever is earlier, an impasse may be called by either party and resolution may be sought by submission of any unresolved issues for mediation by the LRA or a mediator selected through procedures established by the LRA. The parties shall jointly request mediation within five (5) days of a declared impasse. The LRA or other mediator shall set reasonable deadlines for all steps of the mediation process. Negotiations on all matters shall continue throughout impasse procedures.

- (3) The mediation process is advisory only, and the LRA or other mediator shall have no authority to bind either party,
 - (4) The mediation process and any comments, statements, or suggestions from the LRA or other mediator or the parties and any documents evidencing the same made or created during the mediation process shall not be disclosed except as required by law. Communications between an exclusive bargaining representative and the employees that it represents regarding the mediation process shall not constitute public disclosure under this Section.
 - (5) The parties shall share the costs of mediation equally.
- (b) Arbitration: If the City and exclusive bargaining agent are unable to reach agreement resolving any labor-management dispute submitted to mediation as provided for in this article by any deadline set forth in procedures provided in this article or adopted by the LRA, the labor-management dispute shall be submitted to final and nonbinding arbitration subject to the plenary authority of the City Council to determine whether to appropriate funding for the tentative agreement. Such arbitration shall be conducted pursuant to procedures adopted by the LRA which shall, at a minimum, require the parties' joint selection of an arbitrator and shall provide for timing requirements that ensure the conclusion of impasse proceedings on a schedule that complies with Section 112. The parties shall share the costs of arbitration equally. In making a determination under this subsection, the arbitrator shall consider the following factors:
- (1) Stipulations of the parties;
 - (2) The interests and welfare of the public;
 - (3) The financial ability of the employer to meet the financial obligations in the proposed collective bargaining agreement;
 - (4) The overall compensation presently received by the employees involved in the arbitration;
 - (5) Comparison of wages, benefits, and working conditions of the employees involved in the arbitration proceedings with the wages, benefits, and working conditions of other persons performing similar services in the public and private sectors, if applicable;
 - (6) Past collective bargaining agreements between the parties, including the past bargaining history that led to the agreements, or the pre-collective bargaining history of employee wages, benefits, and working conditions;
 - (7) Comparison of working conditions of other City personnel; and

(8) Such other factors that are normally or traditionally taken into consideration in the determination of wages, benefits, and working conditions of employment through voluntary collective bargaining, mediation, arbitration, or otherwise between the parties, in the public sector.

(c) Grievance Procedures: Any grievance, mediation, arbitration, or other resolution procedure negotiated by the parties and available to challenge disciplinary or other personnel actions set forth in Virginia Code Section I 5.2-1506, et seq., shall comply with the minimum requirements set forth in the statute(s), as well as any other statutory grievance rights of law enforcement officers and fire and emergency medical employees.

Sec. 114 - Strikes and other Job Actions.

Pursuant to Virginia Code § 40.1-55, any employee of the City or of any agency or authority of the City who, in concert with two or more other such employees, strikes or willfully refuses to perform the duties of their employment shall be deemed by that action to have terminated their employment and shall be ineligible for employment in any position or capacity during the next 12 months by the City, the Commonwealth of Virginia or any county, city, town or political subdivision of the Commonwealth or any department of any such public entities. The City agrees that no lockout shall take place.

Any employee organization determined to have violated this section shall cease to be accorded recognition under this article, shall cease to receive any dues or fees collected by paycheck withholding and shall not be accorded recognition or receive any dues or fees collected by paycheck withholding for a period of one (1) year.

Sec. 115 - Prohibited Practices.

Neither the City nor any exclusive bargaining agent shall refuse to negotiate in good faith with respect to matters within the scope of collective bargaining as defined in Section 101.

(a) The City and its agents shall not:

- (1) Interfere with, restrain or coerce employees in the exercise of rights granted by this article;
- (2) Dominate or interfere in the administration of any employee organization;
- (3) Encourage or discourage membership in any employee organization, committee, or association including by discrimination in hiring, tenure, or other terms and conditions of employment, provided that use of City property and time for meetings and the City's communication system for employee organization business, as may be permitted by this Article or a collective bargaining agreement, shall not be deemed encouragement prohibited by this subsection;
- (4) Discharge, discriminate, or retaliate against any employee because the employee has filed an affidavit, petition, or complaint or given any information or testimony under this article or because the employee has formed, participated in leadership in, joined, or chosen to be represented by any exclusive bargaining agent;

- (5) Deny the rights accompanying certification as the exclusive bargaining agent as conferred by this article;
- (6) Refuse to participate in good faith in any agreed-upon impasse resolution procedures or those set forth in this article; or
- (7) Refuse to reduce a collective bargaining agreement to writing and sign such agreement provided all conditions for an enforceable agreement, as set forth in this article, have been met.

(b) No employee organization or its agents shall:

- (1) Interfere with, restrain, or coerce any employee with respect to rights granted in this article or with respect to selecting an exclusive representative;
- (2) Willfully fail to represent an employee who is in a bargaining unit exclusively represented by the employee organization fairly regarding matters within the scope of collective bargaining, and without discrimination;
- (3) Refuse to bargain collectively with the City as provided in this article; or
- (4) Refuse to participate in good faith in or violate any agreed-upon impasse resolution procedures or those set forth in this article.

(c) Prohibited practice charge procedures:

- (1) Proceedings against a party alleging a violation of this Section shall be commenced by filing a charge with the LRA within 120 days of the alleged violation, or acquiring knowledge thereof, and causing a copy of the charge to be served upon the accused party in the manner of an original notice as provided in Section 116. The accused party shall have 10 days within which to file a written answer to the charge. The LRA may conduct a preliminary investigation of the alleged violation, and if the LRA determines that the charge has no legal or factual basis, they may dismiss the charge. If the charge is not dismissed, the LRA shall promptly thereafter set a time and place for a hearing. The parties shall be permitted to be represented by counsel or other designated representative, summon witnesses, and request the LRA to subpoena witnesses and the production of records on the requester's behalf. Compliance with the technical rules of pleading and evidence shall not be required.
- (2) The LRA may designate a hearing officer to conduct any hearing. The hearing officer shall have such powers as may be exercised by the LRA for conducting the hearing and shall follow procedures adopted by the LRA for conducting the hearing. The decision of the hearing officer may be appealed to the LRA and the

LRA may hear the case de nova or upon the record as submitted before the hearing officer.

- (3) The LRA shall provide for an official written transcript to report the proceedings, the costs of which shall be borne equally by the parties.
- (4) The LRA shall fill its findings of fact and conclusions. If the LRA finds that the party accused has violated any provision of this Section, the LRA may issue an order directing the party to cease and desist engaging in the violation and may order such other reasonable affirmative relief as is necessary to remedy the violation. Under the provisions for court review of arbitration awards set forth in the Uniform Arbitration Act (Virginia Code §§8.01-581.01 et seq.), the LRA may petition the circuit court for enforcement of an order made under this Section.
- (5) Any party aggrieved by any decision or order of the LRA may within 21 days from the date such decision or order is filed, appeal to the circuit court to obtain judicial review pursuant to the provisions for judicial review set forth in the Uniform Arbitration Act, Virginia Code §§8.01-581.01, et seq.

Sec. 116 - Time Limits.

Any time limits in this article may be extended by written agreement of the City, the employee organization, and any other appropriate parties,

Sec. 117 - Notices.

Any notice required under the provisions of this article shall be in writing, but service of any such notice shall be sufficient if mailed by certified mail, return receipt requested, addressed to the last-known address of the parties, unless otherwise provided in this article or by the rules of the LRA, which rules shall provide for the electronic service of documents. Refusal of certified mail by any party shall be considered service. Prescribed time periods shall commence from the date of the receipt of the notice.

COUNCILOR REQUESTS

CCR-1



CITY OF HOPEWELL CITY COUNCIL ACTION FORM

Strategic Operating Plan Vision Theme:

- Civic Engagement
- Culture & Recreation
- Economic Development
- Education
- Housing
- Safe & Healthy Environment
- None (Does not apply)

Order of Business:

- Consent Agenda
- Public Hearing
- Presentation-Boards/Commissions
- Unfinished Business
- Citizen/Councilor Request
- Regular Business
- Reports of Council Committees

Action:

- Approve and File
- Take Appropriate Action
- Receive & File (no motion required)
- Approve Ordinance 1st Reading
- Approve Ordinance 2nd Reading
- Set a Public Hearing
- Approve on Emergency Measure

COUNCIL AGENDA ITEM TITLE: FY24 Operating Budget

ISSUE: Amend purpose of the Keep Hopewell Beautiful Commission to include tracking environmental violations, approved advocacy and legislative recommendations.

RECOMMENDATION: City Council direct the members of Keep Hopewell Beautiful to generate a list of all DEQ and EPA environmental violations and pollution reports within the City of Hopewell and status of current violations. In addition, obtain the City's air and water quality to provide a baseline and identify areas of opportunity. Review EPA and DEQ policies pertaining to frequent violations to identify recommended City course of action. Lastly, conduct a legislative review to identify potential legislation that may aid in combating violations and as a tool for preemptive support to improve land, air and water violations. Require monthly updates on progress and/or status report to City Council for inclusion in the Regular Meeting packet.

TIMING: Immediate Action; Keep Hopewell Beautiful next Regular Meeting (or Call a Special meeting if not planned)

BACKGROUND: Residents of the City of Hopewell has been subject to repeat violations from internal/external parties. As a result, the physical environment has contributed to the overall health wellness and outcomes of citizens. Members of Hopewell City Council are not notified about violations within the City and/or the resolution status of potential environmental hazards.

ENCLOSED DOCUMENTS:

-

STAFF: Jasmine Gore, Vice Mayor (Ward 4)

SUMMARY:

- | Y | N | | Y | N | |
|--------------------------|--------------------------|-----------------------------------|--------------------------|--------------------------|--|
| <input type="checkbox"/> | <input type="checkbox"/> | Councilor Rita Joyner, Ward #1 | <input type="checkbox"/> | <input type="checkbox"/> | Councilor Janice Denton, Ward #5 |
| <input type="checkbox"/> | <input type="checkbox"/> | Councilor Michael Harris, Ward #2 | <input type="checkbox"/> | <input type="checkbox"/> | Councilor Brenda Pelham, Ward #6 |
| <input type="checkbox"/> | <input type="checkbox"/> | Mayor John B. Partin, Ward #3 | <input type="checkbox"/> | <input type="checkbox"/> | Councilor Dominic Holloway, Sr., Ward #7 |
| <input type="checkbox"/> | <input type="checkbox"/> | Vice Mayor Jasmine Gore, Ward #4 | | | |

FOR IN MEETING USE ONLY

MOTION: _____

Roll Call

SUMMARY:

- | Y | N | |
|--------------------------|--------------------------|-----------------------------------|
| <input type="checkbox"/> | <input type="checkbox"/> | Councilor Rita Joyner, Ward #1 |
| <input type="checkbox"/> | <input type="checkbox"/> | Councilor Michael Harris, Ward #2 |
| <input type="checkbox"/> | <input type="checkbox"/> | Mayor John B. Partin, Ward #3 |
| <input type="checkbox"/> | <input type="checkbox"/> | Vice Mayor Jasmine Gore, Ward #4 |

- | Y | N | |
|--------------------------|--------------------------|--|
| <input type="checkbox"/> | <input type="checkbox"/> | Councilor Janice Denton, Ward #5 |
| <input type="checkbox"/> | <input type="checkbox"/> | Councilor Brenda Pelham, Ward #6 |
| <input type="checkbox"/> | <input type="checkbox"/> | Councilor Dominic Holloway, Sr., Ward #7 |

Keep Hopewell Beautiful

Purpose

The City of Hopewell is an affiliate of [Keep America Beautiful](#). Keep Hopewell Beautiful works to instill community pride and raise awareness of the City's commitment to reducing litter, beautifying our City, and encouraging citizen empowerment to take control of their environment through positive and productive activities.

Advisory Committee

The Keep Hopewell Beautiful Committee (formerly the Clean City Commission) is established by City Council action and consists of 7 members appointed by the City Council. The Keep Hopewell Beautiful Committee is a forum in which to:

- Influence residents of Hopewell to keep the City clean and beautiful
- Implement educational programs about trash and recycling
- Encourage community involvement
- Raise awareness about the environment, recycling, and waste reduction

Volunteer with Us

Keep Hopewell Beautiful is always looking for volunteers and sponsors! Email or call the Department of Development for more information.

Upcoming Events:

[FOLAR Spring Cleanup](#) April 6, 2024

[Earth Day Cleanup](#) April 19, 2024

[Lions Club Cleanup at Weston Circle](#) April 20, 2024

[Earth Day 2024 Event @ City Point](#) April 20, 2024

[Community Cleanup](#) June 8, 2024

ADJOURNMENT