



# DELTA CITY PLANNING & ZONING COMMISSION MEETING

Wednesday, November 08, 2023 at 7:00 PM

Delta City Municipal Complex Council Chambers\*

## AGENDA

### CALL TO ORDER

### MINUTES APPROVAL

1. Meeting Minutes Approval: Planning & Zoning Commission Meeting 2023-10-11

**BUSINESS** – Any such business as may come before the Commission.

2. Kelly Carter: Overson's Farm Center rezone from R4 to CB  
Action: Discussion/Consideration for approval
3. Patrick Smith: Delta Ranch Resort RV Park Plan Review  
Action: Discussion/Consideration for approval
4. Attorney Anderson: Ordinance 23-302: An ordinance amending titles 18 of the delta city code pertaining to, among other things, allowance of townhomes and regulations regarding the same.  
Action: Discussion/Consideration for approval

### ADJOURN

**NOTICE:** Be aware the Planning and Zoning Commission may conduct an Electronic Meeting so that a member of the Public Body may participate, pursuant to UCA §52-4-207, (1953), as amended. Agenda items are considered flexible and may be conducted sequentially different than illustrated herein to meet the needs of the Planning and Zoning Commission. Individuals and entities that have business before the Planning and Zoning Commission should be present at meeting commencement.

**THE PUBLIC IS ENCOURAGED TO PARTICIPATE IN ALL CITY MEETINGS.** In accordance with the Americans with Disabilities Act (ADA), we will make reasonable accommodations for those needing assistance to participate in our meetings. Requests for assistance can be made by contacting the City at 435.864.2759 at least twenty-four hours in advance of the meeting.

### CERTIFICATE OF MAILING & DELIVERY

The below signed, duly appointed and acting City Recorder for Delta City, Utah hereby certifies that a copy of the foregoing Notice and Agenda was e-mailed to the Millard County Chronicle-Progress, LLC, [chronpro@millardccp.com](mailto:chronpro@millardccp.com), published on the Delta City and Utah Public Notices websites and was personally provided to each member of the Planning & Zoning Commission, this **Monday, November 6, 2023**.

Sherri Westbrook, Recorder

1



# DELTA CITY PLANNING & ZONING COMMISSION MEETING

Wednesday, October 11, 2023 at 7:00 PM

Delta City Municipal Complex Council Chambers\*

## MINUTES

2 PRESENT

3 Vice Chairman Kelly Carter

4 Commission Member Phil Diaz

5 Council Liaison Nick Killpack

6 Commission Member Dillon Pace

7 Commission Member Tamara Stewart

8 Commission Member Don Smith (arrived at 7:14)

9 Commission Member Lindsey Dutson

10 NOT PRESENT

11 Chairman Chad Droubay

12 Commission Member Derek Curtis

13 ALSO PRESENT

14 Todd Anderson

15 Dent Kirkland

16 Mayor Niles

17 Michelle Lovejoy

18 Sherri Westbrook

19 KC Bogue

20 CALL TO ORDER

21 Planning and Zoning Commission Vice Chairman Kelly Carter called the meeting to order at 7:00  
22 p.m. He stated that notice of the time, place, and agenda of the meeting had been posted at the  
23 City Municipal Complex, on the Utah Public Notice website, on the Delta City website and had  
24 been provided to the Millard County Chronicle-Progress and each member of the Commission at  
25 least two days before the meeting.

26 MINUTES APPROVAL

27 1. Meeting Minutes Approval: Planning & Zoning Commission Meeting 2023-08-09

28 The Commission would like the wording of alleyways changed to narrow rights-of-way. Council Liaison  
29 Killpack was not present at the meeting held on 2023-08-09, but the minutes note that he is.

30 Commission Member Pace MOVED to approve the minutes of the Planning and Zoning Commission  
31 Meeting held on 8/9/2023 with the noted changes. The motion was SECONDED by Commission  
32 Member Diaz. Vice Chairman Carter asked if there were any questions or comments regarding the  
33 motion. There being none, he called for a vote.

34 Motion made by Pace, Seconded by Diaz.

35 Voting Yea: Vice Chairman Carter, Diaz, Killpack, Pace, Stewart, Dutson

36

37 **BUSINESS** – Any such business as may come before the Commission.

38 2. Attorney Todd Anderson: Townhome Ordinance discussion  
39 Action: Discussion Only

40 Delta City Attorney Anderson opened a townhome ordinance discussion. A definition of a townhome  
41 will need to be added to the city code. Many places do not consider duplexes a townhome so the  
42 minimum number of units would be three. Attorney Anderson asked the commission if they would  
43 allow a duplex to be considered a townhome; Commission Member Diaz remarked that it depended  
44 on which zone it would be built in. R2 allows for a duplex to be built therefore a two-unit townhome  
45 could be built. Commission Member Diaz recommended that townhomes be designated to the R4  
46 zone.

47 Council Liaison Killpack asked about the conversion of a duplex to a townhome by subdividing.  
48 Attorney Anderson answered that if it meets the criteria of the code and satisfies the international  
49 building code, then you could convert a duplex to a townhome. The Planning and Zoning Commission  
50 would have the option to not allow conversion.

51 Commission Member Smith brought up the differences between duplexes and townhomes. Duplexes  
52 can be one level, but townhomes usually have two or three levels.

53 The Commission discussed that the minimum lot requirements would need to be met. Units would not  
54 be allowed on top of each other. The Commission was agreeable with a duplex being a townhome. The  
55 maximum number of units allowed in a townhome would be four.

56 The Commission discussed the landscaping requirements of a townhome. 500 square feet of open  
57 space, a sprinkler system, and a lawn are required now. Commission Member Smith would like  
58 xeriscaping to be an option. Commission Member Smith inquired if there was a time limit for  
59 landscaping and Attorney Anderson said that bonds could be collected. Commission Member Smith  
60 recommended not issuing an occupancy permit until everything is checked off the list. Commission  
61 Member Dutson would like there to be a range of affordability for landscaping. Vice Chairman Carter  
62 recommended not requiring landscaping.

63 Attorney Anderson asked the Commission if they would like to have a washer, dryer, and dishwasher  
64 installation requirement. The Commission recommends having hookups installed. Commission  
65 Member Smith recommended a dishwasher installation be required. Commission Member Diaz wants  
66 a firewall between the units.

67 The Commission discussed off-street parking requirements. Council Liaison Killpack recommended  
68 having three spots per unit. Tandem parking would not be allowed. Commission Member Diaz  
69 recommends having an overflow parking lot and having 3.5 parking spots per unit. The Commission,  
70 excluding Diaz, would recommend three parking spots per unit.

71 The Commission recommended that HVAC be located on each unit's property, and each lot would  
72 need its frontage. Attorney Anderson asked if there would be garage requirements, the Commission  
73 would like to leave that up to the builder.

74 A public hearing will be held before the next Planning and Zoning meeting.  
75

76 **ADJOURN**

77 Council Liaison Killpack MOVED to adjourn the Planning and Zoning Commission Meeting. The motion was  
78 SECONDED by Commission Member Diaz. Vice Chairman Carter asked if there were any questions or  
79 comments regarding the motion. There being none, he called for a vote.

80 Motion made by Killpack, Seconded by Diaz.

81 Voting Yea: Vice Chairman Carter, Diaz, Killpack, Stewart, Smith, Pace, Dutson

82 The meeting was adjourned at 8:15 p.m.  
83

84  
85

---

Sherri Westbrook, Recorder

Unapproved



original



Delta City  
76 N 200 W  
Delta, UT 84624  
435-864-2759, [social@delta.utah.gov](mailto:social@delta.utah.gov)

### Application to Appear

Application # A23-1019-143  
(to be assigned by Delta City)

#### APPLICANT INFORMATION

Applicant Name Oversous Farm Center

Contact Name Kelly Carter

Contact Number 435-406-1862

Contact Email Kellycarterk@gmail.com

Mailing Address 90 N 400 E

City, State, Zip Delta, UT, 84624

#### APPEARANCE INFORMATION

Request to appear before:

City Council       Planning & Zoning       Other: \_\_\_\_\_

Date you wish to appear:  Next available or: \_\_\_\_\_

Subject Summary: Zone Change from R4 to CB

#### Subject Detail:

Be as specific as possible, with as much detail as possible. Include any documents, maps, etc.

Action Requested: Re Zone -

Applicant Signature [Signature] Date 10/19/23

This application, applicable fees and ALL necessary documents must be received at least (8) eight days prior to the scheduled meeting that you wish to attend.

Received by: SW  
Initial Transaction Log #: 2788  
Notes: \_\_\_\_\_

For City Use

Date: 10/19/23  
Fees: \_\_\_\_\_  
Paid Stamp: 500.-

ZONE CHANGE DESCRIPTION

ALL OF THE EAST HALF OF BLOCK 64, PLAT "A", DELTA, TOWNSITE SURVEY, DELTA, UTAH, TO INCLUDE THE VACATED PORTION OF 400 EAST ALONG THE EAST OF SAID BLOCK BEING 19.5 FEET WIDE.

ALSO, THE SOUTH HALF OF THE EAST HALF OF BLOCK 69, DELTA TOWNSITE SURVEY, DELTA, UTAH, TO INCLUDE THE VACATED PORTION OF 400 EAST STREET ALONG THE EAST LINE OF SAID PARCEL.

LESS AND EXCEPTING MILLARD COUNTY PARCEL #D-954-2

BOOK 2 PAGE 57  
SCALE 1"=50  
MARCH 22, 2021

# DELTA, PLAT - A BLOCK 64

(7)

THIS PLAT IS MADE SOLELY FOR THE PURPOSE  
OF ASSISTING IN LOCATING THE LAND AND  
THE RECORDER ASSUMES NO LIABILITY FOR  
VARIATION IF ANY WITH AN ACTUAL SURVEY

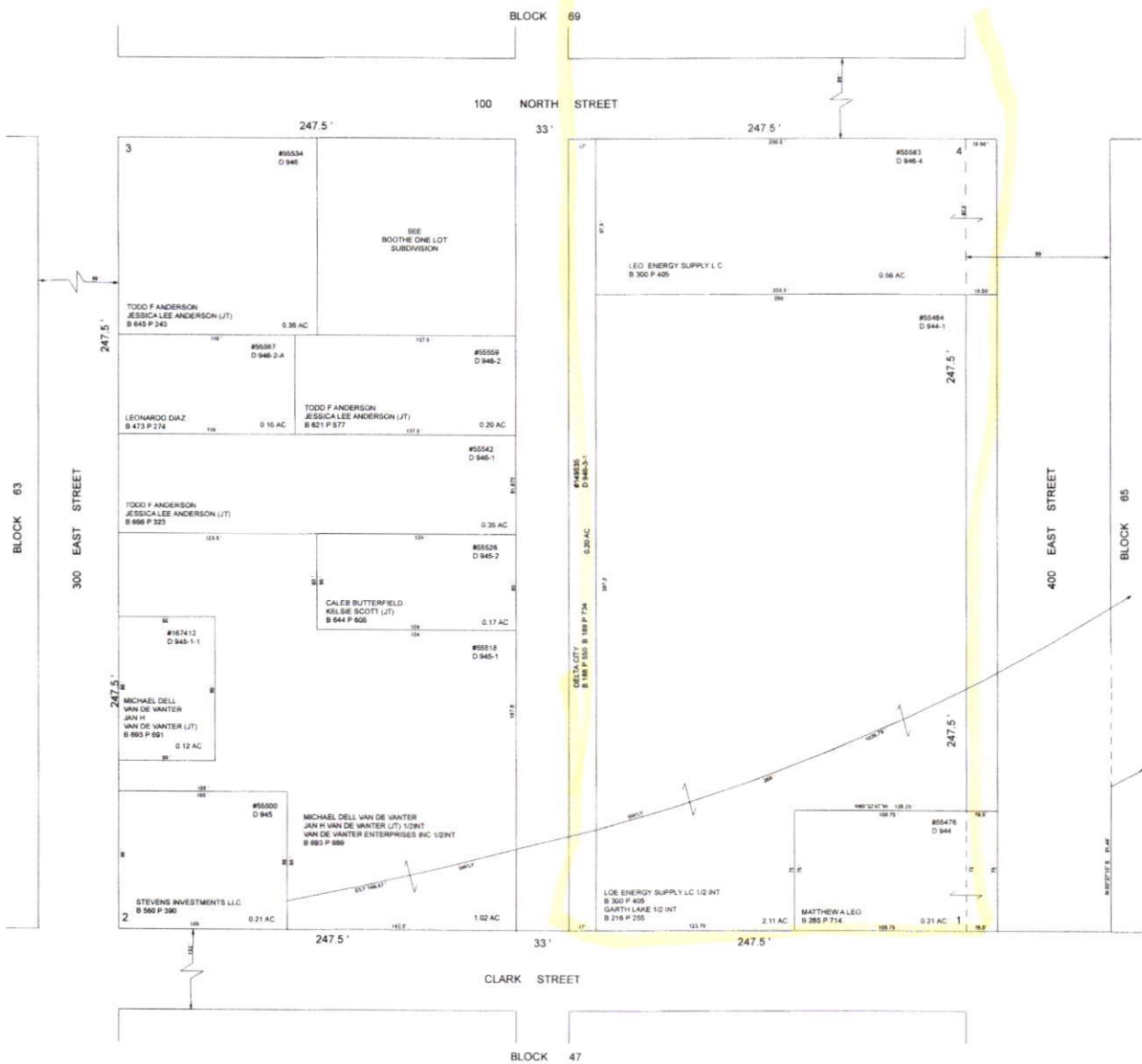

BOOK 2 PAGE 57  
DELTA, PLAT - A  
BLOCK 64

BOOK 2 PAGE 61  
SCALE 1"=50  
MAY 20, 2021

# DELTA, PLAT - A BLOCK 69

(7)

THIS PLAT IS MADE SOLELY FOR THE PURPOSE  
OF ASSISTING IN LOCATING THE LAND AND  
THE RECORDER ASSUMES NO LIABILITY FOR  
VARIATION IF ANY WITH AN ACTUAL SURVEY

BLOCK 86

200 NORTH STREET

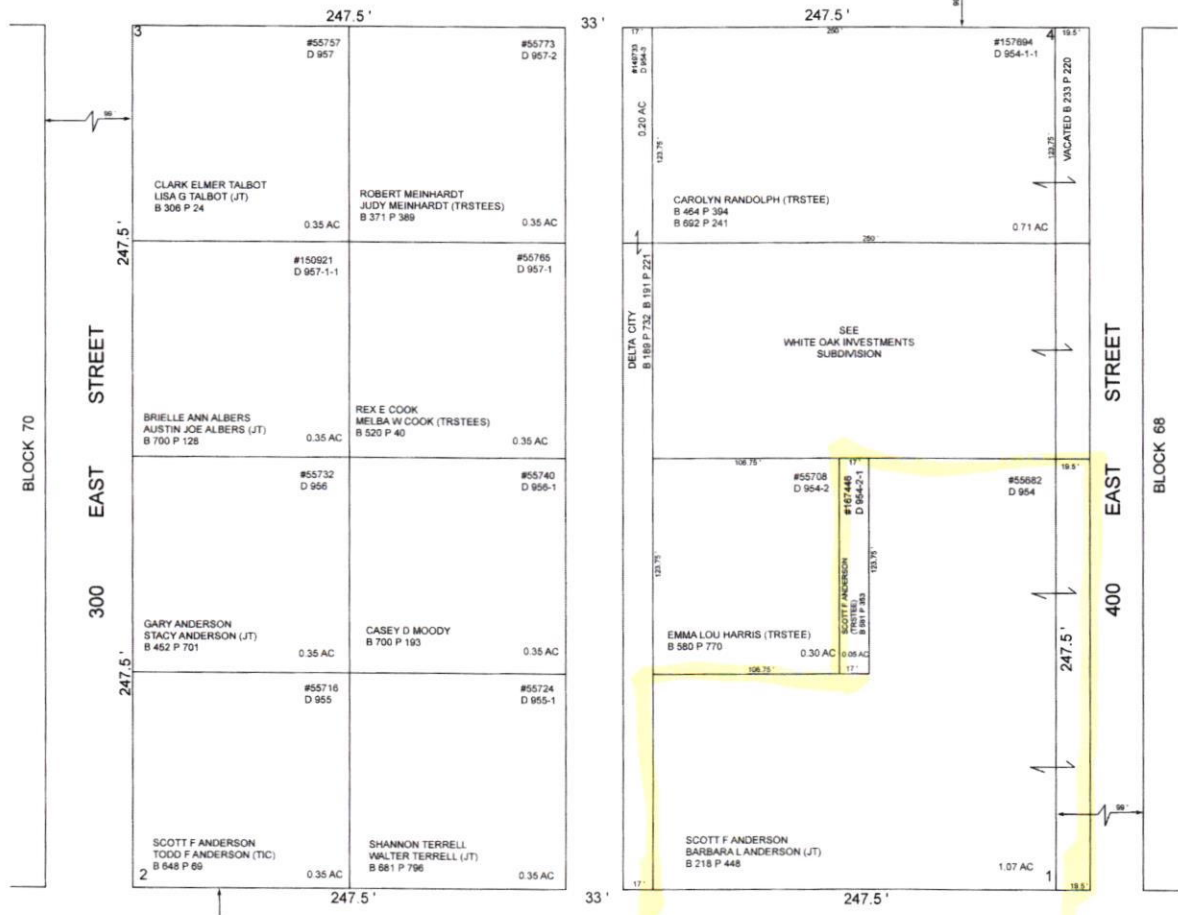

*Tractor Supply.*

100 NORTH STREET

BLOCK 64

BOOK 2 PAGE 61  
DELTA, PLAT - A  
BLOCK 69



 <p><b>Delta City</b> 76 N 200 W Delta, UT 84624 435-864-2759, <a href="mailto:social@delta.utah.gov">social@delta.utah.gov</a></p>	<p><b>Application to Appear</b></p> <p>Application # _____ <small>(to be assigned by Delta City)</small></p>
--	--

**APPLICANT INFORMATION**

Applicant Name Integral Holdings LLC

Contact Name Patrick Smith

Contact Number (304) 268-0893

Contact Email PSmith201@gmail.com

Mailing Address 1185 N Hwy 6

City, State, Zip Delta, UT 84624

**APPEARANCE INFORMATION**

Request to appear before:

City Council       Planning & Zoning       Other: \_\_\_\_\_

Date you wish to appear:  Next available or: \_\_\_\_\_

Subject Summary: Delta Ranch Resort + RV Park Plan Review

**Subject Detail:**  
Be as specific as possible, with as much detail as possible. Include any documents, maps, etc.

See Attached CAD

Action Requested: Planning + Zoning Approval

Applicant Signature *Patrick Smith*      Date 10/25/2023

This application, applicable fees and ALL necessary documents must be received at least (8) eight days prior to the scheduled meeting that you wish to attend.

Received by: _____	For City Use	Date: _____
Initial Transaction Log #: _____		Fees: _____
Notes: _____		Paid Stamp: _____



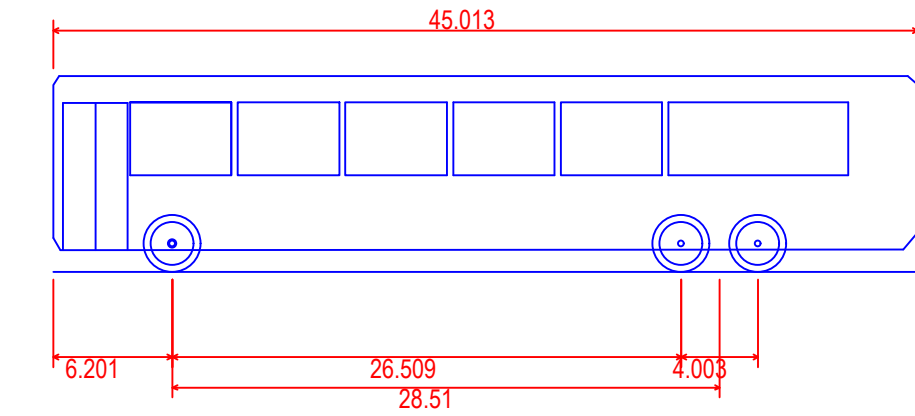

13.72m Bus & Motorhome Design Vehicle  
 Overall Length  
 Overall Width  
 Overall Body Height  
 Min Body Ground Clearance  
 Track Width  
 Lock-to-lock time  
 Max Steering Angle (Virtual)

45.013ft  
 8.497ft  
 10.227ft  
 1.157ft  
 8.497ft  
 6.00s  
 44.30°

RV SITES			
	TYPE	MINIMUM DIMENSION	COUNT
	REGULAR	14' X 60'	58
	ACCESSIBLE	18' X 60'	4
	SHORT	14' X 48' UNLESS NOTED OTHERWISE	1
	TOTAL		63

LIVING STRUCTURES			
	TYPE	DIMENSION	COUNT
	CABINS	31' X 40'	7
	PARK MODEL RVS	26' X 36.67'	6
	AIRBNB	EXISTING	1
	TOTAL		14

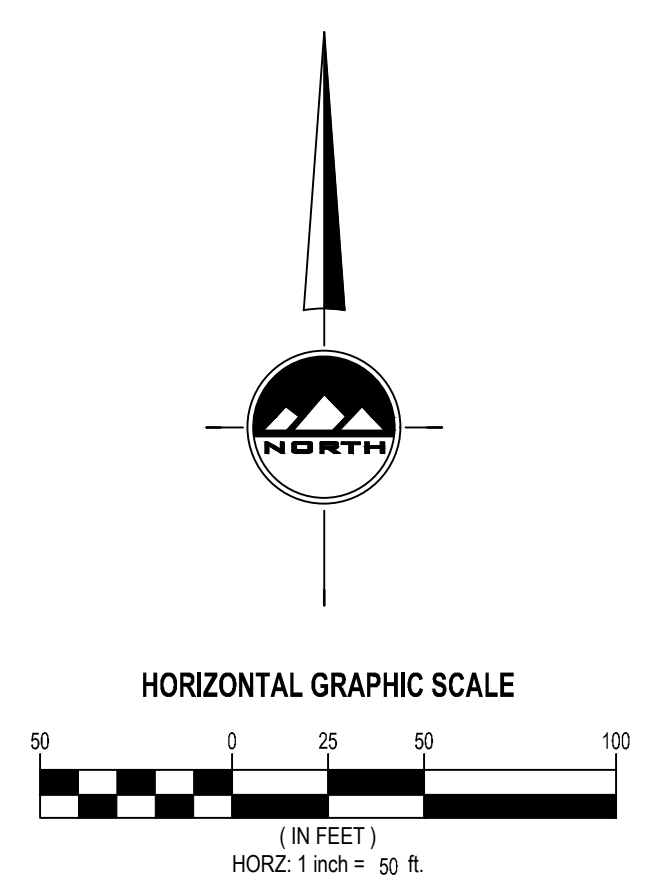

THE STANDARD IN ENGINEERING

**SANDY**  
 45 W. 10000 S., Suite 500  
 Sandy, UT 84070  
 Phone: 801.255.0529

**LAYTON**  
 Phone: 801.547.1100

**TOOELE**  
 Phone: 435.843.3590

**CEDAR CITY**  
 Phone: 435.865.1453

**RICHFIELD**  
 Phone: 435.896.2983

**WWW.ENSIGNENG.COM**

FOR:  
 INTEGRAL HOLDINGS LLC  
 816 ARCHWOOD TRAIL  
 WINCHESTER, VA 22602

CONTACT:  
 PATRICK SMITH  
 PHONE: 304.268.0893

**DELTA RANCH RV RESORT**

1185 HIGHWAY 6  
 DELTA, UTAH

PRELIMINARY

RV  
 VEHICLE TRACKING

PROJECT NUMBER 12471    PRINT DATE 10/26/2023  
 PROJECT MANAGER R. ROUSSELLE    DESIGNED BY M. SANFORD

**EX-2**



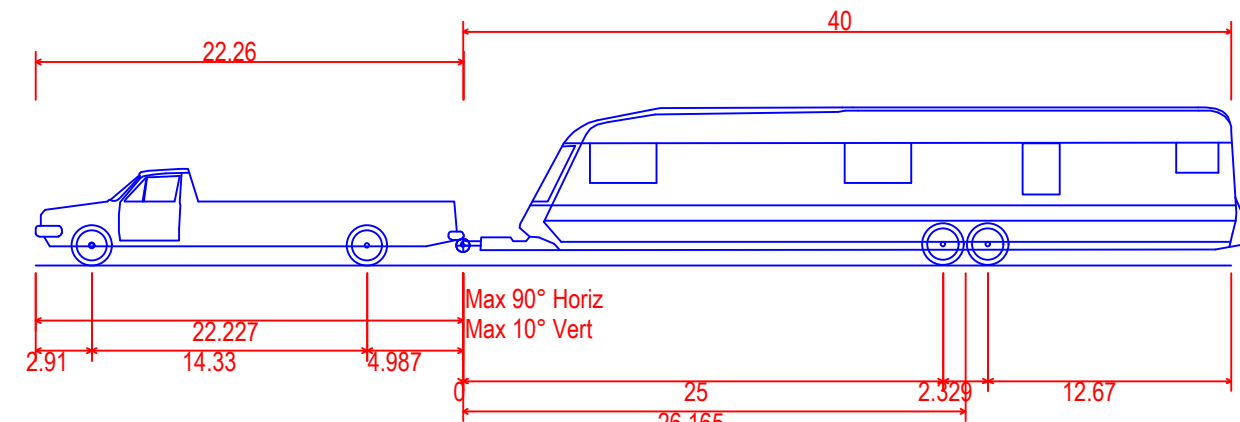

P/T - Car and Camper Trailer-modified to pickup  
 Overall Length 62.227ft  
 Overall Width 8.005ft  
 Overall Body Height 8.251ft  
 Min Body Ground Clearance 0.796ft  
 Max Track Width 8.005ft  
 Lock-to-lock time 4.00s  
 Curb to Curb Turning Radius 70.000ft

RV SITES			
	TYPE	MINIMUM DIMENSION	COUNT
	REGULAR	14' X 60'	58
	ACCESSIBLE	18' X 60'	4
	SHORT	14' X 48' UNLESS NOTED OTHERWISE	1
	TOTAL		63

LIVING STRUCTURES			
	TYPE	DIMENSION	COUNT
	CABINS	31' X 40'	7
	PARK MODEL RVS	26' X 36.67'	6
	AIRBNB	EXISTING	1
	TOTAL		14

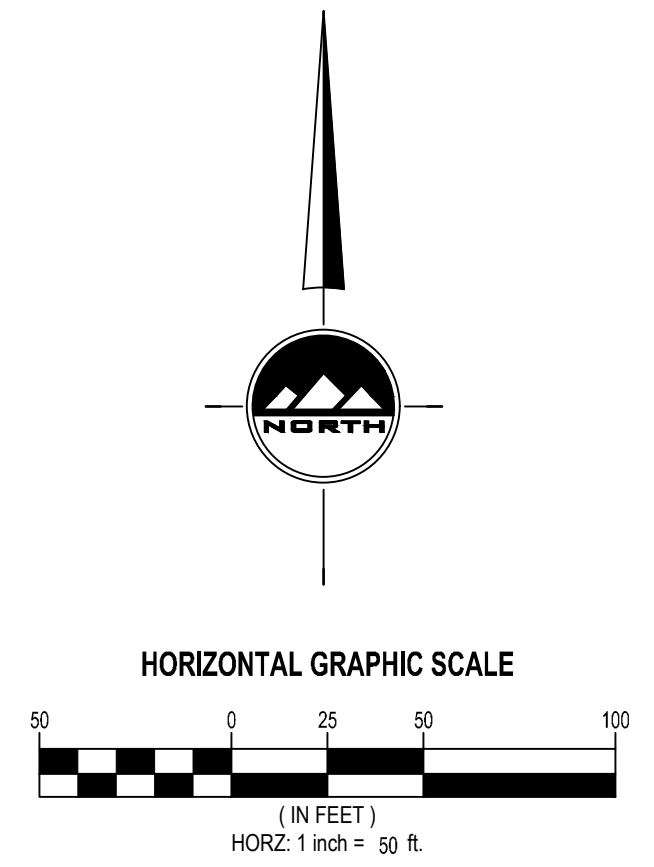

**SANDY**  
 45 W. 10000 S., Suite 500  
 Sandy, UT 84070  
 Phone: 801.255.0529  
  
**LAYTON**  
 Phone: 801.547.1100  
  
**TOOELE**  
 Phone: 435.843.3590  
  
**CEDAR CITY**  
 Phone: 435.865.1453  
  
**RICHFIELD**  
 Phone: 435.896.2983  
  
[WWW.ENSIGNENG.COM](http://WWW.ENSIGNENG.COM)  
  
FOR:  
 INTEGRAL HOLDINGS LLC  
 816 ARCHWOOD TRAIL  
 WINCHESTER, VA 22602  
  
 CONTACT:  
 PATRICK SMITH  
 PHONE: 304.268.0893

**DELTA RANCH RV RESORT**  
  
**1185 HIGHWAY 6**  
**DELTA, UTAH**

**PRELIMINARY**

**TRUCK & CAMPER VEHICLE TRACKING**

PROJECT NUMBER 12471 PRINT DATE 10/25/2023  
 PROJECT MANAGER R. ROUSSELLE DESIGNED BY M. SANFORD  
**EX-1**



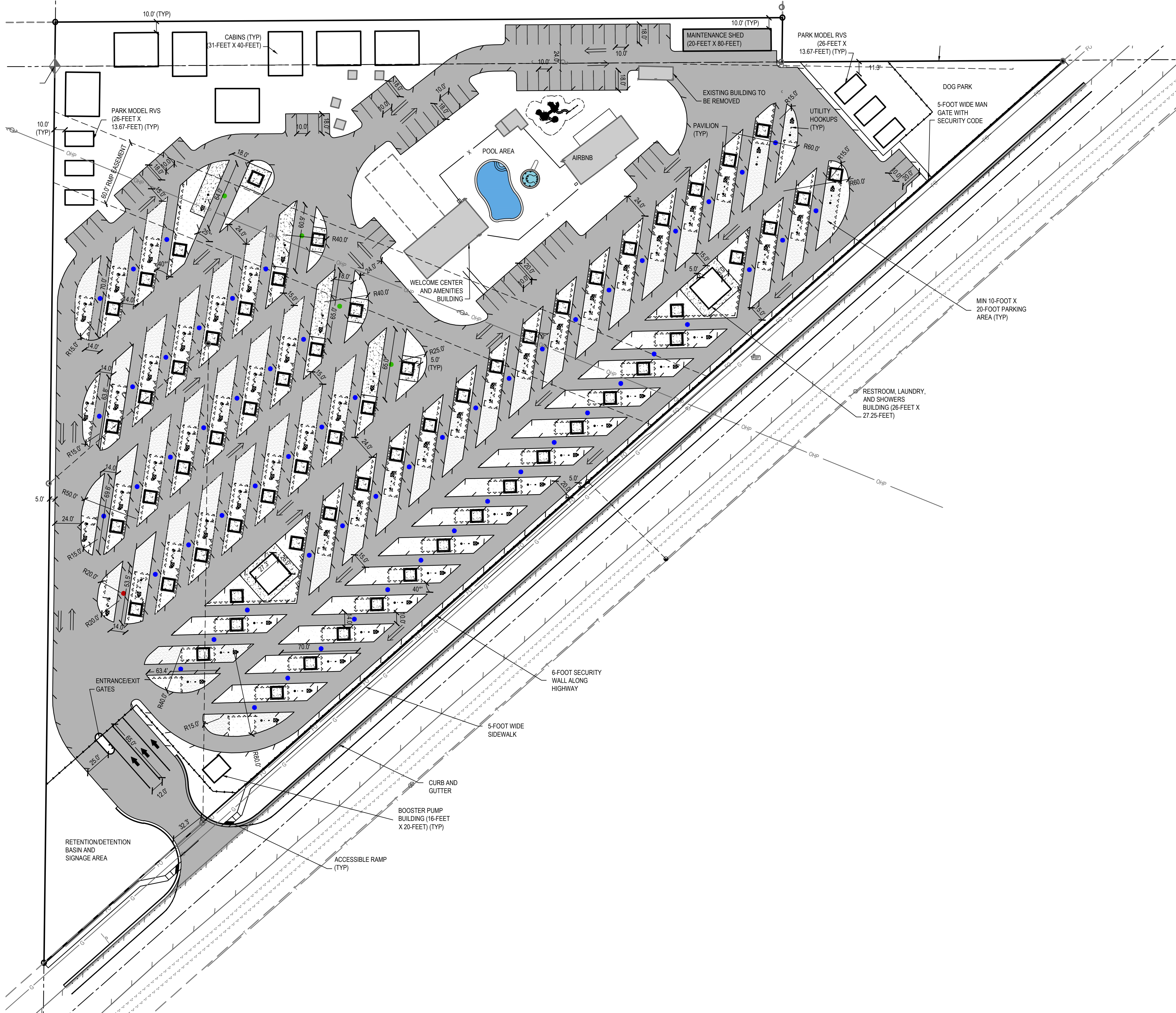

RV SITES			
	TYPE	MINIMUM DIMENSION	COUNT
	REGULAR	14' X 60'	58
	ACCESSIBLE	18' X 60'	4
	SHORT	14' X 48' UNLESS NOTED OTHERWISE	1
	TOTAL		63

LIVING STRUCTURES			
	TYPE	DIMENSION	COUNT
	CABINS	31' X 40'	7
	PARK MODEL RVS	26' X 36.67'	6
	AIRBNB	EXISTING	1
	TOTAL		14

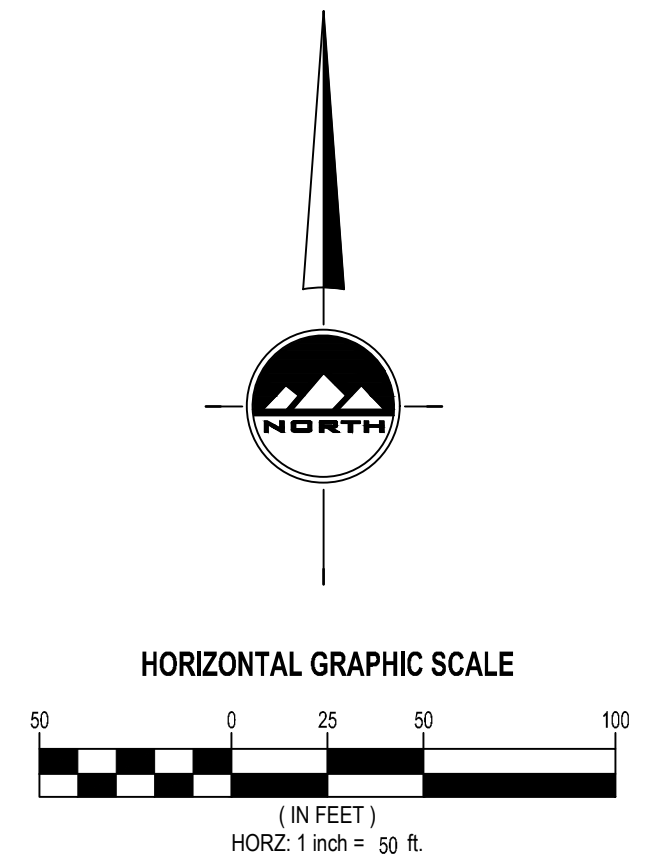

Item 3

**SANDY**  
45 W. 10000 S., Suite 500  
Sandy, UT 84070  
Phone: 801.255.0529

**LAYTON**  
Phone: 801.547.1100

**TOOELE**  
Phone: 435.843.3590

**CEDAR CITY**  
Phone: 435.865.1453

**RICHFIELD**  
Phone: 435.896.2983

[WWW.ENSIGNENG.COM](http://WWW.ENSIGNENG.COM)

FOR:  
INTEGRAL HOLDINGS LLC  
816 ARCHWOOD TRAIL  
WINCHESTER, VA 22602

CONTACT:  
PATRICK SMITH  
PHONE: 304.268.0893

**DELTA RANCH RV RESORT**

**1185 HIGHWAY 6**  
**DELTA, UTAH**

PRELIMINARY

---

SD (30%) SITE LAYOUT

PROJECT NUMBER: 12471      PRINT DATE: 10/25/2023

PROJECT MANAGER: R. ROUSSELLE      DESIGNED BY: M. SANFORD

C-100



## MEMORANDUM

Date: October 26, 2023  
To: UDOT Region 4  
From: Hales Engineering

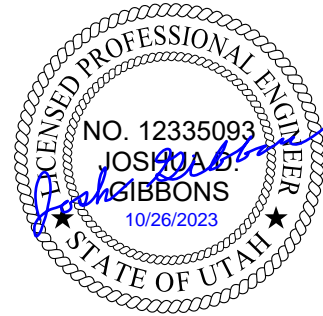

**Subject: Delta Ranch Campground Trip Generation Study**

UT23-2590

### Introduction

This memorandum discusses the trip generation study completed for the proposed Delta Ranch Campground development in Delta, Utah. A vicinity map of the proposed development is shown in Figure 1.



**Figure 1: Vicinity map of the proposed development in Delta, Utah**

**Background**

The proposed development is located at 1185 North U.S. 6 in Delta, Utah. The project includes an RV park and rental cabins.

The proposed land use for the development has been identified as follows:

- RV Park 69 Sites
- Rental Cabins 8 Units

**Trip Generation**

Trip generation for the development was calculated using trip generation rates published in the Institute of Transportation Engineers (ITE) *Trip Generation (11<sup>th</sup> Edition, 2021)*. ITE calculates trip generation for RV Parks based on occupied sites. It is expected that the RV Park will be at 80% occupancy during peak days. The cabins on this site will be rented like Airbnb rentals. Therefore, ITE’s hotel land use was used which is consistent with other studies with similar land uses. Trip generation for the proposed project is included in Table 1.

As shown in Table 1, it is anticipated that the proposed development will generate approximately 216 trips on an average weekday, including 16 trips during the morning peak hour, and 22 trips during the evening peak hour.

**Table 1: Trip Generation**

Trip Generation Delta Ranch Campground								
Land Use <sup>1</sup>	# of Units	Unit Type	Trip Generation			New Trips		
			Total	% In	% Out	In	Out	Total
<b>Weekday Daily</b>								
Campground/RV Park (416)	56	Occ. Sites	152	50%	50%	76	76	152
Hotel (310)	8	Rooms	64	50%	50%	32	32	64
<b>TOTAL</b>			<b>216</b>			<b>108</b>	<b>108</b>	<b>216</b>
<b>AM Peak Hour</b>								
Campground/RV Park (416)	56	Occ. Sites	12	36%	64%	4	8	12
Hotel (310)	8	Rooms	4	56%	44%	2	2	4
<b>TOTAL</b>			<b>16</b>			<b>6</b>	<b>10</b>	<b>16</b>
<b>PM Peak Hour</b>								
Campground/RV Park (416)	56	Occ. Sites	16	65%	35%	10	6	16
Hotel (310)	8	Rooms	6	51%	49%	3	3	6
<b>TOTAL</b>			<b>22</b>			<b>13</b>	<b>9</b>	<b>22</b>

1. Land Use Code from the Institute of Transportation Engineers (ITE) *Trip Generation*, 11th Edition, 2021.  
SOURCE: Hales Engineering, October 2023

### Trip Distribution and Assignment

Project traffic is assigned to the roadway network based on the type of trip and the proximity of project access points to major streets, high population densities, and regional trip attractions. Existing travel patterns observed during data collection also provide helpful guidance to establishing these distribution percentages, especially near the site. It is anticipated that many people living here will be working on construction work at the Intermountain Power Plant to the north. In addition, many of the local recreational destinations are located to the north. These factors were taking into account when determining the distribution. The resulting distribution of project generated trips during the evening peak hour is shown in Table 2.

**Table 2: Trip Distribution**

Direction	% To/From Project
North	75%
South	25%

These trip distribution assumptions were used to assign the evening peak hour trip generation at the project’s access to create trip assignment, since the evening peak hour has the highest entering volume. Trip assignment for the development consists of the following turning movements at the project’s access during the evening peak hour:

- 9 southwest-bound ingress right-turns
- 4 northeast-bound ingress left-turns
- 6 southeast-bound egress left-turns
- 3 southeast-bound egress right-turns

### Auxiliary lanes

Auxiliary lanes are deceleration (ingress) or acceleration (egress) turn lanes that provide for safe turning movements that have less impact on through traffic. These lanes are sometimes needed at accesses or roadway intersections if right- or left-turn volumes are high enough.

UDOT Administrative Rule R930-6 outlines minimum peak hour turn volumes to warrant auxiliary lanes on UDOT roadways. The following are the minimum requirements for these lanes on U.S 6: (which is classified by UDOT access management standards as an access category 2 roadway).

- Left-turn Deceleration (Ingress): >5 left-turn vehicles per hour
- Left-turn Acceleration (Egress): Is there a safety benefit?
- Right-turn Deceleration (Ingress): >10 right-turn vehicles per hour
- Right-turn Acceleration (Egress): >10 right-turn vehicles per hour

Based on these guidelines and the anticipated project traffic, no auxiliary lanes are recommended at the project access.

### **Conclusions**

The findings of this study are as follows:

- The proposed development includes an RV park, and cabin rentals. It is anticipated that the project will have one access.
- It is anticipated that the proposed project will generate approximately 216 trips on an average weekday, including 16 trips during the morning peak hour, and 22 trips during the evening peak hour.
- Based on UDOT guidelines and the anticipated project traffic, no auxiliary lanes are recommended at the project access.

If you have any questions regarding this memorandum, please contact us at 801.766.4343.



WATER DEMANDS  
TOTAL SYSTEM  
ELEVATION = 4710 ft

Project: Delta Valley Ranch RV Resort  
Project No.: 12471  
Date: 10/25/2023

By: Dylan Cooper  
Checked By: Robert Rousselle

**INDOOR WATER DEMANDS**

ITEM NO.	TYPE OF USE	UNITS OR BUILDING AREA (UNITS OR SQ FT) (a)	% of ERC (b)	ERCs (c) =(a)*(b)	SOURCE SIZING AND WATER RIGHTS				STORAGE SIZING		DISTRIBUTION SIZING	
					PEAK DAY			AVERAGE YEARLY		UNIT DEMAND (GAL/ERC) (i) (Note 1)	TOTAL DEMAND (GAL) (j) =(c)*(i)	PEAK INSTANTANEOUS DEMAND (GPM) (k) (Note 2)
					UNIT DEMAND (GPD/ERC) (d) (Note 1)	TOTAL DEMAND (GPM) (e) =(c)*(d)/1440	(GPD) (f) =(c)*(d)	UNIT DEMAND (AC-FT/ERC) (g) (Note 1)	TOTAL DEMAND (AC-FT) (h) =(c)*(g)			
1.	Recreational Vehicle Park	69	13.0%	9.0	800	5.0	7,176	0.218	2.0	400	3,588	-
2.	Ammenity Building	1	31.25%	0.3	800	0.2	250	0.218	0.1	400	125	-
3.	Existing House	1	100.0%	1.0	800	0.6	800	0.218	0.2	400	400	-
4.	Pool	1	25.0%	0.3	800	0.1	200	0.218	0.1	400	100	-
5.	Cabins	7	50.0%	3.5	800	1.9	2,800	0.218	0.8	400	1,400	-
6.	Laundry Room in Ammenity Building	2	73%	1.45	800	0.8	1,160	0.218	0.3	400	580	-
<b>INDOOR WATER DEMANDS TOTAL</b>				<b>15</b>		<b>8</b>	<b>11,226</b>		<b>3</b>		<b>5,613</b>	<b>62.36</b>

- NOTES:**
- The peak day unit demand, average yearly unit demand, and storage unit demand are given in the Utah Admin Code R309-510.
  - Unit counts were from the latest site layout.
  - The swimming pool capacity was assumed to be 20 people.
  - The existing house is assumed to be one ERC.
  - Cabins are assumed to one half an ERC.
  - The amenity building is being considered an office building with a cafeteria for 10 employees.
  - The laundry room within the ammenity building is assumed to have two washers and half the recommended peak day demand from table 510-2 in the Utah State Admin Code.

**OUTDOOR WATER DEMANDS**

ITEM NO.	TYPE OF USE	UNITS OR LAND AREA (UNITS OR ACRES) (aa)	% IRRIGATED (bb)	IRRIGATED AREA (ACRES) (cc) =(aa)*(bb)	SOURCE SIZING AND WATER RIGHTS				STORAGE SIZING		DISTRIBUTION SIZING	
					PEAK DAY			AVERAGE YEARLY		UNIT DEMAND (GAL/ACRE) (ii) (Note 1)	TOTAL DEMAND (GAL) (jj) =(cc)*(ii)	PEAK INSTANTANEOUS DEMAND (GPM) (kk) =(ee)*2
					UNIT DEMAND (GPM/ACRE) (dd) (Note 1)	TOTAL DEMAND (GPM) (ee) =(cc)*(dd)	(GPD) (ff) =(ee)*1440	UNIT DEMAND (AC-FT/ACRE) (gg) (Note 1)	TOTAL DEMAND (AC-FT) (hh) =(cc)*(gg)			
1.	Landscaping	4.09	100%	4.09	3.96	16.2	23,323	1.87	7.6	2,848	11,648	32.4
<b>OUTDOOR WATER DEMANDS TOTAL</b>				<b>4.1</b>		<b>16.2</b>	<b>23,322.8</b>		<b>7.6</b>		<b>11,648.3</b>	<b>32.4</b>

- NOTES:**
- The peak day unit demand, average yearly unit demand, and storage unit demand are given in the Utah Admin Code R309-510.
  - The only outdoor water use was assumed to be for irrigation and these values will need to be confirmed once irrigated areas are updated.
  - 
  - 
  -

**FIRE FLOW DEMANDS**

ITEM NO.	TYPE OF USE	FLOW	DURATION	STORAGE REQUIREMENT (GAL)
		(GPM)	(HOURS)	
1.	Fire Flow	1,500	2	180,000

- NOTES:**
- Fire flow is anticipated to be 1,500 gpm for 2 hours, but will need to be confirmed with the Fire Marshal.
  - 
  - 
  - 
  -

**TOTAL SYSTEM DEMANDS**

	PEAK DAY DEMAND		AVERAGE YEARLY DEMAND (AC-FT)	STORAGE REQUIREMENT (GAL)	PEAK INSTANTANEOUS DEMAND (GPM)
	(GPM)	(GPD)			
<b>TOTAL (INDOOR + OUTDOOR)</b>	<b>24</b>	<b>34,549</b>	<b>11</b>	<b>17,261</b>	<b>94.8</b>
<b>TOTAL + FIRE FLOW</b>				<b>197,261</b>	



ITEM NO.	TYPE OF USE	UNITS OR BUILDING AREA (UNITS OR SQ FT) (a)	% of ERC (b)	ERCs (c) =(a)*(b)	AVERAGE DAY			PEAKING FACTOR (g) (Note 1)	PEAK DAY		
					UNIT FLOW (GPD/ERC) (d) (Note 1)	TOTAL FLOW			UNIT FLOW (GPD/ERC) (h) =(d)*(g)	TOTAL FLOW	
						(GPD) (e) =(c)*(d)	(GPM) (f) =(e)/1440			(GPD) (i) =(c)*(h)	(GPM) (j) =(i)/1440
1.	Recreational Vehicle Park	69	13.0%	9.0	400	3,588	2.5	4.00	1,600	14,352	10.0
2.	Ammenity Building	1	31.25%	0.3	400	125	0.1	4.00	1,600	500	0.3
3.	Existing House	1	100.0%	1.0	400	400	0.3	4.00	1,600	1,600	1.1
4.	Pool	1	25.0%	0.3	400	100	0.1	4.00	1,600	400	0.3
5.	Cabins	7	50.0%	3.5	400	1,400	1.0	4.00	1,600	5,600	3.9
6.	Laundry Room in Ammenity Building	2	73.0%	1.5	400	584	0.4	4.00	1,600	2,336	1.6
<b>TOTAL SYSTEM SEWAGE GENERATION</b>				<b>15</b>		<b>6,197</b>	<b>4.3</b>			<b>24,788</b>	<b>17</b>

**NOTES:**

1. The peak day unit demand, average yearly unit demand, and storage unit demand are given in the Utah Admin Code R309-510.
2. Unit counts are per the latest layout.
3. The swimming pool capacity was assumed to be 20 people.
4. The existing house is assumed to be one equivalent residential connection (ERC).
5. Cabins are assumed to be one half an ERC.
6. The amenity building is being considered an office building with a cafeteria for 10 employees.
7. The laundry room within the amenity building is assumed to have two washers and half the recommended peak day demand from table 510-2 in the Utah State Admin Code.

**DELTA CITY  
ORDINANCE 2023-302**

**AN ORDINANCE AMENDING TITLES 18 OF THE DELTA CITY CODE  
PERTAINING TO, AMONG OTHER THINGS, ALLOWANCE OF TOWNHOMES  
AND REGULATIONS REGARDING THE SAME.**

**WHEREAS,** The "Municipal Land Use, Development, and Management Act", Utah Code Ann. § 10- 91- 101 et seq., as amended( the "Act"), provides that each municipality of the State of Utah may enact a land use ordinance and a zoning map establishing regulations for land use and development within the municipality;

**WHEREAS,** Pursuant to the Act, the municipality's planning commission shall prepare and recommend to the municipality's legislative body, following a public hearing, proposed land use ordinances and zoning maps, or amendment thereto, that represent the planning commission's recommendations for land use regulations within the municipality;

**WHEREAS,** The Delta City Planning Commission has caused to be drafted the attached amendments to Titles 18 of the Delta City Code, and has recommended to the City Council that the amendments be adopted by Delta City.

**NOW THEREFORE,** be it ordained by the Council of the Delta City, in the State of Utah, as follows:

**SECTION 1:** **AMENDMENT** "18.04.010 DEFINITIONS" of the Delta Municipal Code is hereby *amended* as follows:

**BEFORE AMENDMENT**

**18.04.010 DEFINITIONS**

For the purpose of this title, certain numbers, abbreviations, terms and words shall be used, interpreted and defined as set forth herein. Words not defined herein shall have a meaning consistent with Webster's New Collegiate Dictionary, latest edition. Unless the context clearly indicates to the contrary, words used in the present tense include the future tense; words used in the plural number include the singular; the word "herein" means "in these regulations"; the word "regulations" means "these regulations"; "used" or "occupied", as applied to any land or building, shall be construed to include the words "intended, arranged or designed to be used or occupied".

**ACCESSORY BUILDING, LARGE:** An accessory building larger than six hundred (600) square feet that is located on the same lot as a residence.

**ACCESSORY DWELLING UNIT:** A building on the same lot as the principal building and that is:

- A. Clearly incidental to, and customarily found in connection with, such principal building;
- B. Operated and maintained for the benefit of the principal use; and
- C. A dwelling unit or home office.

Also includes the following:

1. "Accessory Apartment" means a housing unit which is self-contained but incorporated within the footprint of the primary dwelling as at the time the internal accessory dwelling unit is created and will not substantially alter the structure or the appearance of the structure. An accessory apartment is a complete, separate housing unit that shall be within the original dwelling unit.
2. "Guesthouse" means a detached living quarters located within an accessory building that is subordinate to, and located on the same premises with, a primary dwelling, occupied solely by members of the family and temporary guests. Such facilities shall not be rented independently from the main dwelling unit.

**ACCESSORY BUILDING, UNOCCUPIED:** A building on the same lot as the principal building and that is:

- A. Clearly incidental to, and customarily found in connection with, such principal building;
- B. Operated and maintained for the benefit of the principal use; and
- C. Not a dwelling unit.

**ACCESSORY LIVING QUARTERS:** Accessory dwelling incidental to a church or airport.

**ACCESSORY USE OR BUILDING:** A subordinate use or building customarily incidental to and located upon the same lot occupied by the main use or building.

**ACTIVE BUILDING PERMIT:** An unexpired and unrevoked building permit for which the building inspector has not performed a final inspection and has not issued a certificate of occupancy.

**ADULT ORIENTED BUSINESSES:** Any or all of the following or any portions of the following: adult book store, adult video store, adult novelty store, adult motion picture theater, adult theater and tattoo parlors.

**AFFECTED ENTITY:** A county, municipality, local district under Utah Code 17B-1, Local Districts, school district, interlocal cooperation entity established under Utah Code 11-13, Interlocal Cooperation Act, a property owner, a property owner association, specified public utility, or the Utah Department of Transportation, if:



- A. The entity's services or facilities are likely to require expansion or significant modification because of an intended use of land;
- B. The entity has filed with the Municipality a copy of the entity's general or long range plan; or
- C. The entity has filed with the Delta City Recorder a request for notice during the same calendar year.

**AGRICULTURAL INDUSTRY OR BUSINESS:** An industry or business involving agricultural products in manufacturing, packaging, treatment, sales or storage, including, but not limited to, food packaging or processing plants, and similar uses. This definition does not include hog farms, commercial poultry businesses or rendering facilities.

**AGRICULTURE:** The tilling of soil, raising of crops, horticulture, gardening and other similar uses.

**AGRICULTURE (IF LOT IS 1 OR GREATER):** See definition of agriculture. Lot must be greater than or equal to one (1) acre in size.

**ALTERATIONS, STRUCTURAL:** Any change in the supporting members of a building, such as bearing walls, columns, beams or girders.

**ANIMAL HOSPITAL OR VETERINARY OFFICES:** An establishment where animals are medically treated, lodged or trained by a licensed veterinarian.

**ANIMAL WASTE:** The excrement and discharge from an animal, or animal carcasses, tissues or any other substance or material capable of transmitting disease or disease carrying agents.

**ANTENNA:** A transmitting or receiving device used in telecommunications that radiates or captures radio, television or similar communication signals.

**ANTENNA, FREESTANDING:** An antenna mounted on the roof of or within a stand alone support structure, including, but not limited to, a wooden pole, steel pole, lattice tower, utility pole, lift tower, light standard, flag pole or other vertical support.

**ANTENNA, ROOF MOUNTED:** An antenna or series of individual antennas mounted on the roof of a building.

**ANTENNA, TEMPORARY:** An antenna used for a time period of less than thirty (30) days.

**ANTENNA, WALL MOUNTED:** An antenna or series of individual antennas mounted fully against the exterior face of a building including on the face of a chimney. A wall or face of a building is defined as the entire area of all exposed vertical surfaces of a building that are aboveground and facing approximately the same direction.

**ANTENNA, WHIP:** An antenna that is cylindrical in shape. Whip antennas can be directional or omni-directional and vary in size depending upon the frequency and gain for which they are designed.

**APPEAL AUTHORITY:** An individual or group of individuals appointed by the City Council through resolution, or, in the event of no such appointment being made, a board made up of the Delta City Council as provided in this title.

**APPLICANT:** An owner, occupant or authorized agent, or a contractor or person with control of the property or lot that is the subject of the application.

**APPLICATION:** A written request for development approval, including, but not limited to, an alteration or revision to an approved master planned development, zoning or rezoning, subdivision or annexation. The term "application" shall not include any building permits associated with construction within an approved subdivision or on an existing platted lot unless otherwise specified.

**ASSEMBLY FACILITY:** A facility where parts are put together to develop a final product. Generally referring to automobile, computer and electronic assembly.

**ASSISTED LIVING CENTER:** Residences that provide for semi-independent living. Such facilities may be: a) equipped with a studio or one bedroom apartments with limited kitchen facilities, generally designed for single occupancy; b) contain central dining facilities where prepared meals are served to the residents; c) employ full time nursing or medical assistance and supervision; and d) may provide other additional services to residents.

**ATHLETIC CLUB:** An establishment providing facilities for physical development exercise, sports or recreation. Facilities may include exercise equipment, indoor and/or outdoor racquetball or tennis courts, jogging track, swimming pools, ice skating rink, indoor bathing, restaurant or snack bar, and sales of athletic equipment. Facilities may be open to the public for a fee, or available only to persons holding membership.

**ATTORNEY:** The person, or persons, appointed by the City Council, to be the Delta City Attorney.

**AUTO, TRUCK, RECREATIONAL VEHICLE AND EQUIPMENT SALES AND RENTAL:** Sales of both new and used motor vehicles and equipment stored and displayed both indoors and on outside lots, but not to include nonserviceable or junk vehicles or equipment.

**AUTO WRECKING, SALVAGE YARD:** The use of any lot, portion of lot or tract of land for the storage and keeping of salvage, including scrap metals or other scrap material, unlicensed/inoperable vehicles, or for the dismantling or demolition of obsolete automobiles or equipment machinery, or parts thereof. This definition shall not be deemed to include such uses which are clearly accessory and incidental to any agricultural use permitted in the zone district.

**AUTOMOTIVE BODY/PAINT REPAIR ESTABLISHMENT:** All buildings, structures, and premises where motor vehicles are stored, rented or sold, or where motor vehicles are repaired, oiled, greased, adjusted or worked upon in any manner whatsoever and for which a charge is made.

**AUTOMOTIVE REPAIR ESTABLISHMENT:** An establishment primarily engaged in the repair or maintenance of motor vehicles, trailers and similar large mechanical equipment.

**AUTOMOTIVE SELF-SERVICE STATION:** An establishment for the retail sale of automobile fuels and lubricants, at which the customer provides the service to his own vehicle, and at which no vehicle repair or maintenance service is offered. Such an establishment may offer for sale at retail other convenience items as a clearly secondary activity. Stations located at interstate exchanges catering to semi-trucks, which also include accommodations for truckers, also known as truck stops.

**AUTOMOTIVE SERVICE STATION:** An establishment whose primary purpose is the retail sale of gasoline or other motor vehicle and related fuel, oil or lubricant. Secondary activities may include minor automotive repair, maintenance or automatic car wash.

**AVIATION AIRPORT - ACCESSORY LIVING QUARTERS:** The same as accessory building, occupied; built and maintained by or at the Delta City Airport.

**AVIATION AIRPORT SERVICES:** Area containing an aviation landing strip, runway, hangar or other related services needed for aircraft.

**BALCONY:** A platform that projects from the wall of a building and is enclosed by a railing, parapet or balustrade.

**BANKING OR FINANCIAL SERVICE:** A bank, credit union, savings and loan association, or other establishment with a primary purpose of receiving, lending, exchanging or safeguarding money, or performing financial advisory service. This definition shall include outside drive-up facilities for service to customers in automobiles.

**BAR, TAVERN, LOUNGE AND CLUB:** An establishment intended primarily for the on premises sale and consumption of alcoholic beverages, open either to the public or operated as a nonprofit private club for members only.

**BASEMENT:** A story whose floor is more than twelve inches (12") below the average level of the adjoining ground, but where no more than half of its floor to ceiling height is below the average contact level of the adjoining ground. A basement shall be counted as a story for purposes of height measurement and as a half-story for purposes of side yard determination.

**BED AND BREAKFAST:** A building where, for compensation, meals and lodging are provided for at least five (5) but not more than fifteen (15) persons.

**BOND, PUBLIC IMPROVEMENT:** A one year guarantee to the City that all public improvements have been installed to City specifications and will operate properly.

**BUILDING:** Any structure, whether temporary or permanent, having a roof, and used or built for the shelter or enclosure of persons, animals, possessions or property of any kind.

**BUILDING AREA:** The portion of a lot that is within the envelope formed by the required yards or setbacks, within which a structure can be located.

**BUILDING HEIGHT:** The vertical distance from the average finished grade surface at the building wall to the highest point of the coping of a flat roof or to the deck line of a mansard roof, or the mean height level between eaves and ridge for gable, hip or gambrel roofs.

**BUILDING INSPECTOR:** Delta City official known as the Construction Enforcement Officer who is designated to inspect buildings under construction and upon completion.

**BUILDING, MAIN:** A building within which the principal land use of the lot is conducted.

**BUSINESS:** Any activity carried on for the purpose of gain or economic profit. The acts of employees rendering service to employers are not included in the term business unless otherwise specifically prescribed. Business includes, but is not limited to, the sale or rental of tangible personal or real property, the manufacturing of goods or property and the rendering of personal services for others for consideration by persons engaged in any profession, trade, craft, occupation, nonprofit organization or other calling.

**BUSINESS, COMMERCIAL, LESS INTENSIVE:** A business that does not include automotive, heavy equipment or twenty four (24) hour uses. May be with or without a drive up window.

**CANOPY:** A roof or awning constructed of fabric or other material and extending outward from a building to provide a protective shield for doors, windows or other openings with supports extended to the ground directly under the canopy or cantilevered from the building.

**CARPORT:** A roofed structure, open on at least three (3) sides, designed for or occupied by private passenger vehicles. Except for in the case of a permitted encroachment pursuant to DCC 18.64.070 paragraph B, for the purposes of this title, a carport shall be subject to all regulations prescribed for a private garage.

**CEMETERY, COLUMBARIUM, CREMATORY, MAUSOLEUM:** Land or buildings used for the cremation, burial or interment of the human dead, but not including facilities for embalming.

**CHIEF EXECUTIVE OFFICER:** The Mayor of Delta City.

**CHILD PLACING:** Receiving, accepting or providing custody or care for any child under eighteen (18) years of age, temporarily or permanently, for the purpose of: finding a person to adopt the child; placing the child temporarily or permanently in a home for adoption; or foster home placement.

**CHILDCARE CENTER:** The provision of childcare for business for eight (8) or fewer children, including the provider's children who are under the age of eighteen (18), within a dwelling unit.

**CHILDCARE FACILITY:** The provision of childcare for business for nine (9) or more children, including the provider's children who are under the age of eighteen (18).

**CHURCH:** A building set apart primarily for the purpose of worship in which religious services are held and with which clergy is associated, the main body of which is kept for that use and not put to any other use inconsistent with its primary purpose, and which is tax exempt under the laws of the State of Utah.

**CHURCH, ACCESSORY LIVING QUARTERS:** See accessory building, occupied; built and maintained by the religious organization. **CHURCH (FORTY FEET (40') FROM ALL PROPERTY LINES, NO RESIDENCE WITHIN):** See definition of church. The building must be forty feet (40') from all property lines, no residence within.

**CINEMA, INDOOR:** An enclosed building used primarily for the presentation of motion pictures.

**CINEMA, OUTDOOR:** An establishment at which motion pictures are projected onto an outdoor screen for viewing by patrons seated in parked motor vehicles.

**CITY COUNCIL:** The Governing Body of Delta City.

**CIVIC CLUB, FRATERNAL ORGANIZATION:** A building or use, other than a church or school, operated by a nonprofit association or organization for a social, fraternal, political, civic or philanthropic purpose, which may include a meeting hall and cooking and dining facilities for large groups, but shall not provide overnight lodging.

**CLEAR VISION AREA:** An area outlined by the sight distance triangle where solid fencing or natural vegetation is restricted to a height of three feet (3') and where all structures or other items that would obstruct vision are prohibited. See definition of sight distance triangle.

**CLUB, PRIVATE:** Any nonprofit corporation or organization, operating as a social club, recreational, fraternal, athletic or kindred association organized primarily for the benefit of its stockholders or members and serving alcoholic beverages and/or food.

**COAL YARD:** The storage of coal in quantities in excess of ten (10) tons and/or the retail or wholesale sale of coal.

**CODE ENFORCEMENT OFFICER:** The Delta City official known as the Zoning and Land Use Enforcement Officer. The Code Enforcement Officer shall be one and the same as any reference in any Delta City ordinance, resolution or policy that references a "Zoning Officer", "Land Use Administrator", or any other title of a public official with duties regarding zoning and land use enforcement and shall have any and all discretion, duties and responsibilities as set out in such Delta City ordinance, resolution or policy.

**COLLECTOR STREET:** See definition of street, collector.

**COLLOCATION:** The location of a telecommunication facility on an existing structure, tower or building in a manner that precludes the need for that telecommunications facility to be located on a freestanding structure of its own.

**COMPLETE APPLICATION:** A submission, which includes all information requested on the appropriate form, and full payment of all applicable fees.

**CONGREGATE LIVING FACILITY:** A residence in which three (3) or more persons unrelated to the owner or provider reside, including, but not limited to, youth homes, residential facilities for the disabled or residential facilities for the elderly.

**CONSERVATION EASEMENT:** An easement designed to restore, enhance, protect and sustain the quality and quantity of ecosystems and natural resources.

**CONSTITUTIONAL TAKING:** Final action by the City to physically take or exact private real property that requires compensation to the owner because of the mandates of the Fifth or Fourteenth Amendments to the Constitution of the United States, or article I, section 22, of the Utah Constitution.

**CONSTRUCTION STANDARDS:** The standards and specifications set out in this title or maintained by the City.

**CONVENIENCE GOODS SALES AND SERVICES:** Stores or shops intended for retail sales of convenience goods or performance of convenience services. Goods and services regarded as convenience are those generally needed for daily home consumption and for which locations near residential neighborhoods are considered desirable. This category includes grocery store, drug store, variety store, personal service, hardware store, dry cleaning pick up and uses considered similar and compatible.

**COUNCIL:** Members of the City Council of Delta.

**COUNTY:** The unincorporated area of Millard County.

**COURT:** An open, unoccupied space, other than a yard, on the same lot with a building or group of buildings and which is bounded on two (2) or more sides by such building or buildings.

**COVERAGE:** The percent of the total site area covered by structures or impervious paving other than those accepted in this title.

**CUL-DE-SAC:** A minor street having an open end and being terminated at the other end by a vehicle turnaround.

**CULINARY WATER AUTHORITY:** The department, agency or public entity with responsibility to review and approve the feasibility of the culinary water system and sources for the subject property.

**CULTURAL, CIVIC SERVICES:** A building primarily used for the public, nonprofit display of art, historic or cultural artifacts, or other inanimate exhibits or a building primarily used as a lending library or reading room.

**DAIRY:** A commercial establishment housing animals for the processing and/or retail sale of dairy products.

**DELTA CITY CONSOLIDATED FEE SCHEDULE (OR FEE SCHEDULE):** A document adopted by resolution of the Delta City Council listing fees charged by Delta City to offset regulatory and administrative service costs of Delta City.

**DEVELOPMENT:** The act, process or result of erecting, placing, constructing, remodeling, converting, altering, relocating or demolishing any structure or improvement to property, including grading, clearing, grubbing, mining, excavating or filling of such property. This definition includes construction activity.

**DISABILITY:** A physical or mental impairment that substantially limits one or more of a person's major life activities, including a person having a record of such an impairment or being regarded as having such an impairment. Disability does not include current illegal use of, or addiction to, any Federally controlled substance, as defined in section 102 of the Controlled Substances Act, 21 USC 802.

**DISABLED CARE:** A long term care residential facility for disabled persons or persons suffering from a physical or mental impairment that substantially limits one or more of a person's major life activities, including a person having a record of such impairment or being regarded as having such impairment.

**DISTRICT:** A portion of the area of Delta City, Utah, shown on a zoning map (attached to the ordinance codified herein) and given a zone classification as set forth in this title.

**DRIVE TEST, ANTENNA:** A temporary antenna, which is used for field testing of telecommunications signals and possible locations, but does not provide telecommunications to customers.

**DRY CLEANING ESTABLISHMENT:** An establishment employing volatile or explosive substances for the cleaning or dyeing of fabrics. Excluded from this definition are traditional laundries employing water and soaps in the cleaning of fabrics and patron operated dry cleaning machines associated with laundromats.

**DWELLING:** Any building, or portion thereof, which is designed for use for residential purposes of one family or individual with suitable approved provisions for eating, sleeping, cooking, and sanitation, except to not include hotels, boarding houses, lodging houses and tourist cabins.

**DWELLING, FOUR-FAMILY:** A building arranged or designed to be occupied by four (4) families, the structure having only four (4) dwelling units.

DWELLING, SINGLE-FAMILY: A building arranged or designed to be occupied by one family, the structure having only one dwelling unit.

DWELLING, THREE-FAMILY: A building arranged or designed to be occupied by three (3) families, the structure having only three (3) dwelling units.

DWELLING, TWO-FAMILY: A building arranged or designed to be occupied by two (2) families, the structure having only two (2) dwelling units.

EASEMENT: A negotiated interest in the land of another which allows the easement holder specified uses or rights without actual ownership of the land.

ELDERLY CARE: A long term care residential facility for the elderly. The term does not include a healthcare facility.

ELDERLY PERSON: A person who is sixty (60) years old or older, and who desires or needs to live with other elderly persons in a group setting, who may or may not be capable of living independently.

ENGINEER: The person or firm appointed by the City Council to be the Delta City Engineer.

EQUIPMENT SHELTER: A structure used to house equipment for telecommunications facilities.

ESCROW: A deposit of cash with the City or an approved, alternate security in lieu of cash held to ensure a guarantee.

FARM ANIMALS/LIVESTOCK: Animals other than household pets that may, where permitted, be kept and maintained on private property.

FARM ANIMALS/LIVESTOCK (NON-COMMERCIAL USES): See Farm animals/livestock. Commercial use of animals/livestock or goods produced including but not limited to meat, eggs, manure, etc. are prohibited.

FEE SCHEDULE: See definition of Delta City consolidated fee schedule.

FENCE: A physical barrier to delineate, contain or designate an area designed for a specific use, such as an enclosure for a dwelling unit, an area of storage, etc.

FENCE, ELECTRIC: A fence wired with low voltage (12 volt maximum) electricity.

FENCE, RAZOR: A fence with razor coil, cable or tooth wire along certain portions.

FENCE, WILDLIFE/LARGE ANIMAL: Any inherently sturdy steel or solid wood fencing, which may be coupled with wire or other materials for the purpose of containing or deterring large animals or wildlife from passage. Open fencing allowed at a height of six feet (6') or more when a need is shown to protect animals from entering or leaving an area.



**FINAL ACTION:** The latter of the final vote or the approved, written decision on a matter.

**FINAL PLAT:** A recordable subdivision.

**FIREWORKS SALES/STANDS:** The temporary display and sale of legally allowed fireworks. This use requires a business license and a temporary permit issued from the Delta City Fire Chief or his/her designee after the business has had a satisfactory fire inspection.

**FLOOR AREA, GROSS:** The area of a building, including all enclosed areas designed for human occupation. Gross floor area does not include unenclosed porches, balconies, patios and decks, vent shafts, courtyards or garages, up to a maximum floor area of six hundred (600) square feet.

**FLOOR AREA, NET LEASABLE:** Gross floor area excluding common hallways, mechanical and storage areas, and restrooms.

**FLOOR AREA RATIO (FAR):** The maximum allowed gross floor area divided by the area of the lot or parcel.

**FRONT:** The front side of a lot or parcel shall be that side which abuts a street or land on which vehicular ingress or egress to the lot occurs.

**FRONTAGE:** The length of the property line of the lot fronting on one side of a street.

**GARAGE, COMMERCIAL:** A building other than a private garage used for the temporary parking of automobiles with or without a fee.

**GARAGE, PRIVATE (Including UNENCROACHING CARPORT):** A detached accessory building or portion of a main building for the parking or temporary storage of automobiles of the occupants of the premises.

**GATED COMMUNITY:** A subdivision or residential area where primary access is regulated through a gated entry point.

**GENERAL MERCHANDISE SALES AND RELATED SERVICES:** Stores, department stores or shops intended for sale of goods or merchandise, but not including convenience goods, liquor, motor vehicles, campers, trailers or lumber.

**GENERAL PLAN:** A document that a Municipality adopts that sets forth general guidelines for proposed future development of the land within the Municipality, as set forth in Utah Code §§ 10-9a-401 and 10-9a-302.

**GOVERNING BODY:** The Delta City Council.

**GRADE:**

- A. For buildings adjoining more than one street, the average of the elevations of the

sidewalks at the centers of all walls adjoining streets.

- B. For buildings adjoining one street only, the elevation of the sidewalk at the center of that wall adjoining the street.
- C. For buildings having no wall adjoining the streets, the average level of the ground (finished surface) adjacent to the exterior walls of the buildings.
- D. All walls approximately parallel to and not more than five feet (5') from a street line are to be considered as adjoining a street.

**GROUP HOME:** A profit or nonprofit boarding home for the sheltered care of persons with special needs, which, in addition to providing food and shelter, may also provide some combination of personal care, social or counseling services, and transportation. Group home includes congregate facilities for all persons.

**GROUP HOME, ASSISTED LIVING FACILITY:** A residential facility, licensed by the state of Utah, with a home-like setting that provides an array of coordinated support personnel and healthcare services, available twenty-four (24) hours per day, to residents who have been assessed under the Utah Department of Health or whom the Utah Department of Human Services requires or recommends any of these services. Each resident shall have a service plan based on the assessment, which may include: a) Specified services of intermediate nursing care; b) Administration of medication; and c) Support services promoting resident's independence and self-sufficiency. Such a facility does not include adult day care provided in conjunction with a residential facility for elderly persons or a residential facility for persons with a disability.

**GROUP HOME, DISABLED:** A residence in which more than one person with a disability resides and is licensed or certified by the Utah Department of Human Services or the Department of Health. This term includes a recovery residence and a residential treatment facility as defined in Utah Code § 62A-2-101.

**HANDICAPPED PERSON:** A person who has a severe, chronic disability that is attributable to mental or physical impairments, that is likely to continue indefinitely, and that results in a substantial functional limitation in three (3) or more of the following areas of major life activity: capacity for independent living; economic self-sufficiency; learning; mobility; receptive and expressive language; self-care; self-direction; and requires special interdisciplinary or generic care, treatment or other services that are individually planned and coordinated to allow the person to function in, and contribute to, a residential neighborhood.

**HEALTH DEPARTMENT:** The Utah State Division of Environmental Health or local health agency having jurisdiction.

**HEALTHCARE CENTER (CONVALESCENT CENTER):** A publicly or privately operated facility, other than a hospital, intended for the long term, inpatient care of human illness or infirmity, including the elderly and developmentally disabled, normally employing the services of skilled and licensed practitioners.

**HEAVY/FARM EQUIPMENT SALES:** Vehicles or equipment in excess of one ton used in farming, construction or other related services.

**HEIGHT, BUILDING:** The vertical distance from the existing grade to the highest point of the cornice of a flat roof or to the deck line of a mansard roof or to the midpoint of the highest gable of a pitch or hip roof.

**HOME OCCUPATION:** Any use conducted entirely within a single-family dwelling and carried on by persons residing within the dwelling unit, which use is clearly incidental and secondary to the use of the dwelling purposes and does not change the character thereof and in connection with which there is no display, nor stock in trade. The home occupation shall not include the sale of commodities except those which are produced on the premises and shall not involve the use of any accessory building or yard space or activity outside the main building, not normally associated with residential use. There shall be no advertising of any kind in connection with the home occupation; there shall be no employees outside of the family residing in the dwelling unit. There shall be no perceivable increase in local traffic. A home occupation may include emergency consultation, but shall not be for the general practice or profession.

**HOSPITAL:** An institution designed for the diagnosis, treatment and care of human illness or infirmity and providing health services, primarily for inpatients, and including as related facilities, laboratories, outpatient departments, training facilities and staff offices, but not including clinics or healthcare centers.

**HOTEL:** A building designed or occupied as the more or less temporary abiding place of fifteen (15) or more individuals who are, for compensation, lodged, with or without meals.

**HOUSEHOLD PETS:** Animals or birds ordinarily permitted in the house and kept for company or pleasure, such as dogs, cats and canaries, but not including a sufficient number of dogs to constitute a kennel, as defined in this section.

**IMPROVEMENTS:** Includes all roads, streets, curbs, gutters, gradings, landscaping, water and sewer systems, drainage systems, public facilities and sewer materials required by this title.

**INACTION:** An application is inactive and subject to denial on the basis of inactivity if, through the act or omission solely of the applicant and not of the City:

- A. More than six (6) months has passed since a request for additional information was made by the City without a response from the applicant;
- B. Upon notice the applicant is more than sixty (60) days in default of the payment of any fee assessed by resolution, or has not paid the fee under protest;
- C. The applicant has stated an intent to abandon the project; and
- D. The application appears to have been filed in bad faith for the purpose of attempting to vest rights prior to a zoning change, without actual intent to construct the project applied for.

**INDUSTRIAL (OR RESEARCH) PARK:** A tract of land that is subdivided and developed according to a plan for the use of a community of industries and related uses and that is of sufficient size and physical improvement to protect surrounding areas and the general community and to assure a harmonious integration into the neighborhood.

**INDUSTRY, LIGHT:** The manufacturing, compounding, processing, assembling, packaging or testing of goods or equipment entirely within an enclosed structure, with no outside storage, serviced by small (3/4 ton) trucks or vans, and imposing a nearly negligible impact upon the surrounding environment by noise, vibration, smoke, dust or pollutants.

**INDUSTRY, MEDIUM:** The manufacturing, compounding, processing, assembling, packaging or testing of goods or equipment within an enclosed structure, or an open yard that is capable of being screened from neighboring properties, is serviced by trucks or other vehicles, and whose environmental impact is within the industrial performance standards as outlined in this title.

**INTERMITTENT USE:** A temporary business of selling and delivering goods, wares and merchandise within the City of Delta.

**ITINERANT MERCHANT:** Any person, firm or corporation, whether as owner, agent, consignee or employee, whether or not a resident of the Municipality, who engages in a temporary business of selling and delivering goods, wares and merchandise within the Municipality, and who, in furtherance of such purpose, hires, leases, uses or occupies any building, structure, motor vehicle, tent, railroad boxcar, public room in any hotel, motel, lodging house, apartment, shop or any street, alley or other place within the Municipality, for the exhibition and sale of such goods, wares and merchandise, either privately or at public auction. This also includes a person, firm or corporation associating temporarily with a local dealer, trader, merchant or auctioneer, or by conducting such transient business in connection with, as part of, or in the name of any local dealer, trader, merchant or auctioneer.

**JUNKYARD:** The use of any lot, portion of a lot, or tract of land for the storage, keeping or abandonment of junk, including scrap metals or other scrap materials, or for the dismantling, demolition or abandonment of automobiles, other vehicles, or machinery or parts thereof; provided, that this definition shall not be deemed to include such uses which are clearly accessory and incidental in the district.

**KENNEL, COMMERCIAL:** A shelter for or a place for three (3) or more dogs or cats are bred, boarded or trained for monetary gain.

**KENNEL, PRIVATE:** A shelter for or a place for three (3) or more dogs or cats are bred, boarded or trained for no monetary gain.

**LAND USE APPLICATION:** An application required by a Municipality's land use ordinance.

**LAND USE AUTHORITY:** A person, board, commission, agency or other body designated by the local legislative body to act upon a land use application.

LAND USE ORDINANCE: A planning, zoning, development or subdivision ordinance of the Municipality, but does not include the general plan.

LATTICE TOWER: A self-supporting multiple sided, open steel frame structure used to support telecommunications antenna equipment.

LAUNDROMAT: An establishment in which patrons wash, dry or dry clean clothing and other fabrics in coin operated, self-service machines.

LAUNDRY: An establishment at which clothing and other fabrics are washed and pressed. Excluded from this definition are dry cleaning establishments and laundromats.

LEASABLE, GROSS: Total area including hallways, mechanical equipment room and common bathrooms.

LEASABLE, NET: Total area excluding hallways, mechanical equipment room and common bathrooms.

LEGISLATIVE BODY: The Delta City Council.

LIQUOR STORE: A retail sales store authorized by the Utah Department of Alcoholic Beverage Control to sell packaged alcoholic beverages for off premises consumption.

LOCAL JURISDICTION: Delta City.

LOT: A parcel of land occupied or to be occupied by a main building or group of buildings (main and accessory), together with such yards, open spaces, lot width and lot area as are required by this title and having frontage upon a street.

LOT, CORNER: A lot situated at the intersection of two (2) streets, the interior angle of such intersection does not exceed one hundred thirty five degrees (135°). A corner lot fronts two (2) streets.

LOT DEPTH: The horizontal distance between the front and rear lot lines measured in the main direction of the side lot line.

LOT LINE: Property lines bounding the lot.

LOT LINE ADJUSTMENT: The relocation of the property boundary line between two (2) adjoining lots with the consent of the owners of record, so long as no new lot is created, and the adjustment does not violate this title.

LOT LINE, FRONT: The property line dividing a lot or parcel from the right-of-way of the street from which structure takes access.

LOT LINE, REAR: The property line opposite the front lot line.

LOT LINE, SIDE: Any lot or property line other than a front or rear lot line.

**LOT WIDTH:** The minimum distance between the side lot lines at the front yard or front building facade. For three (3) sided lots, the minimum distance between the rear and side lot lines at the front yard or front building facade.

**LOW POWER RADIO SERVICES FACILITY:** An unmanned structure, which consists of equipment used primarily for the transmission, reception or transfer of voice or data through radio wave or wireless transmissions. Such sites typically require the construction of transmission support structures to which antenna equipment is attached.

**LUMBER SALES AND STORAGE:** The sale and display of lumber and building supplies, including the outside storage of lumber and related merchandise.

**MAJOR STREET PLAN:** The major street plan of Delta City.

**MANUFACTURED HOME:** A structure, transportable in one or more sections, which in the traveling mode, is eight (8) body feet or more in width or forty (40) body feet or more in length, or, when erected on site, is three hundred twenty (320) or more square feet, and which is built on a permanent chassis and designed to be used as a dwelling with or without a permanent foundation when connected to the required utilities, and includes the plumbing, heating, air conditioning and electrical systems contained therein. Calculations used to determine the number of square feet in a structure will be based on the structure's exterior dimensions measured at the largest horizontal projections when erected on site. These dimensions will include all expandable rooms, cabinets and other projections containing interior space, but do not include bay windows. This term includes all structures which meet the above requirements except the size requirements and with respect to which the manufacturer voluntarily files a certification pursuant to 24 CFR 3282.13, and complies with the standards set forth in 24 CFR part 3280.

**MANUFACTURING USE:** Research and development facilities, testing laboratories and facilities for the production, fabrication, processing or assembly of goods and products.

**MASSAGE THERAPY SERVICES:** See definition of office, professional.

**MASTER PLAN:** The master plan of Delta City.

.

**MEDICAL CLINIC:** See definition of office, professional.

**MENTAL HEALTH CENTER:** A publicly or privately operated facility, intended for the diagnosis and treatment of mental or emotional disorders.

**MILITARY SURPLUS GOODS/STORE:** New or used military equipment, vehicles or supplies, which are available for resale to the general public.

MIXED USE, COMMERCIAL: Development which incorporates a mix of uses, including retail commercial and/or offices and residential.

MIXED USE, HORIZONTAL: Commercial and residential uses which are within close proximity to each other and designed in a "village" manner, but not necessarily within the same building structures.

MIXED USE, VERTICAL: Commercial and residential uses, which are within the same building structure.

MOBILE HOME: A detached single-family dwelling unit of not less than thirty feet (30') in length, designed for long term occupancy and to be transported on its own wheels or on a flatbed or other trailers or detachable wheels; containing a flush toilet, sleeping accommodations, a tub or shower bath, kitchen facilities, and plumbing and electrical connections provided for attachment to appropriate external systems, and ready for occupancy except for connections to utilities and other work. Presectionalized modular, or prefabricated houses not placed on permanent foundations, shall be regarded as mobile homes and only authorized in mobile home parks.

MOBILE HOME LOT: A designated portion of a mobile home park, designed for the accommodation of one mobile home and its accessory buildings or structures which complies with all relevant Building Codes and ordinances.

MOBILE HOME PAD: Part of the mobile home space which has been prepared and reserved for the placement of one mobile home.

MOBILE HOME PARK: A residential development in which owners of mobile homes or manufactured housing may rent or lease a lot on which to place their home. Such developments may provide all of the amenities and improvements typical of subdivisions.

MOBILE HOME PARK PLUMBING SYSTEM: The park sewer and water supply systems within the park property line.

MOBILE HOME PARK SEWAGE SYSTEM: Any pipe or line not built into the mobile home which is used for the disposal of human waste.

MOBILE HOME SERVICE BUILDING: A building which is not a mobile home which houses separate toilet and bathing facilities for men and women and which may also have laundry facilities, flushing rim sink, and other facilities as may be required by the ordinances of the City of Delta.

MODEL HOME: A dwelling unit used initially for display or marketing purposes, with a certificate of occupancy, which typifies the units that will be constructed.

MODULAR HOME: A permanent dwelling structure built of prefabricated units which are assembled and erected on the site, and which meets the International Building Code.

**MONOPOLE:** A single cylindrical steel or wood pole that acts as the support structure for antennas.

**MONUMENT SIGN:** A sign six feet (6') or less in height which is flush to the ground.

**MORTUARY, FUNERAL HOME:** An establishment in which the human dead are prepared for burial or cremation. The facility may include a chapel for the conduct of funeral services, spaces for informal gatherings and related accessory uses.

**MOTEL:** A building or group of buildings containing individual sleeping units designed and used primarily for the accommodation of transient automobile travelers and with automobile parking immediately accessible.

**MUNICIPAL FACILITIES:** Those improved properties owned by the Municipality or the public.

**NATURAL WATERWAYS:** Those areas, varying in width, along streams, creeks, springs, gullies or washes that are natural drainage channels as determined by the building inspector.

**NARROW RIGHT-OF-WAY:** A right-of-way that is forty feet(40') or less.

**NEW DEVELOPMENT:** Any new construction activity.

**NONCOMPLYING STRUCTURE:** A structure that legally existed before its current zoning designation and because of a zoning change, does not conform to the zoning district's development standards.

**NONCONFORMING SIGN OR SIGN STRUCTURE:** A sign or sign structure or portion thereof lawfully existing prior to August 16, 2012, which does not conform to all height, area, yard spacing, animation, lighting or other regulations prescribed in the zone in which it is located.

**NONCONFORMING USE:** A use of a lot or parcel that legally existed on the lot or parcel before its current zoning designation; has been maintained continuously for the preceding twelve (12) months; and does not conform with the zoning regulations that now govern the land.

**NURSERY:** A business that grows, cultivates and/or distributes and sells plants and other landscaping or horticulture related items.

**NURSERY (PERSONAL USE):** A use wholly, or partially, contained within one or more greenhouses where trees, shrubs, flowers, or vegetable plants are grown for personal use. For-profit sales of goods are prohibited.

**NURSING HOME:** A business described also as a "rest home" or "convalescent home", other than a hospital, in which persons are lodged long term and furnished with care rather than diagnoses or treatment.



**OFFICE, BUSINESS OR GOVERNMENT:** A place intended for the conduct of administration or services by a business enterprise or unit of government.

**OFFICE, PROFESSIONAL:** A place intended for the conduct of a recognized learned profession. Such uses include offices or clinics devoted to treatment and care of human illness or injury (medical, dental, chiropractic offices, massage therapist and similar uses). Other professions so defined would include, but not be limited to, accountants, architects, engineers and lawyers. Definition does not allow for inpatient care facilities or adult oriented businesses.

**OFFICIAL STREETS MASTER PLAN:** As adopted by the City Council, the designation of each existing and planned street and right-of-way, and those located on approved and filed plats, for the purpose of providing for the development of the streets, highways, roads and rights-of-way and for their future improvement, reconstruction, realignment and necessary widening, including provision for curbs and sidewalks. The classification of each street and right-of-way is based upon its location in the respective zoning district of the City, its present and estimated future traffic volume and its relative importance and function.

**OFFICIAL ZONING MAP:** The map adopted by the City Council pursuant to law showing the streets, zoning districts and City boundaries; and any amendments or additions thereto resulting from the approval of rezones, subdivision or annexation plats and the subsequent filing of such approved plats.

**OPEN SPACE:** Space reserved in parks, courts, playgrounds, golf courses and other similar open areas and those areas reserved to meet the density requirements of planned unit development. **ORDINARY HIGH WATER MARK:** The line on the bank to which the high water ordinarily rises annually in season as indicated by changes in the characteristics of soil, vegetation or other appropriate means, which consider the characteristics of the surrounding areas. Where the ordinary high water mark cannot be found, the top of the channel bank shall be substituted. In braided channels, the ordinary high water mark or substitute shall be measured so as to include the entire stream feature.

**OUTDOOR RECREATION, PARK OR PLAYGROUND (PUBLIC OR PRIVATE):** An area free of buildings, except for restrooms, dressing rooms, equipment storage and maintenance buildings, and open air pavilions and used primarily for recreation activities not involving motor vehicles or overnight use.

**OUTDOOR RECREATIONAL USES:** Recreational activities involving off highway vehicles and similar motorized vehicles for recreational use and horse arenas, equestrian parks and equine activity, including, but not limited to, equine shows, fairs, competitions, performances, racing or sales that involve any breed of equines and any equine disciplines; boarding or training equines and teaching persons equestrian skills. The Planning Commission may also determine other equine activities that are consistent with this section.

**OWNER:** Any person, or group of persons, having record title to the property sought to be developed or subdivided and the owner's agent.

**PARCEL:** An unplatted unit of land described by metes and bounds and designated by the County Recorder's Office with a unique tax identification number.

**PARCEL OF LAND:** An area of land all portions or divisions of which are contiguous and in the possession or ownership of one person.

**PARKING AREA:** An unenclosed area or lot, other than a street, used or designed for parking, nine feet by eighteen feet (9' x 18').

**PARKING AREA, PRIVATE:** An open area, other than a street, used for the parking of the automobiles of occupants of a dwelling, or hotel..

**PARKING, PUBLIC:** A parking area or parking facility to be used by the public for fee or otherwise.

**PARKING, RESIDENTIAL:** A parking area or structure used exclusively for residential, noncommercial uses.

**PARKING, SHARED:** The development and use of parking areas on two (2) or more separate properties for joint use by the businesses or residents on those properties.

**PARKING SPACE, AUTOMOBILE:** A space within a building or a private or public parking area, exclusive of driveways, ramps, columns and office and work areas, for the parking of one automobile.

**PARTIAL STREET:** The portion of a street within a subdivision comprising the minimum required right-of-way on which improvements are constructed to width of one-half (1/2), plus ten feet (10') over the centerline of the typical street cross section, as set out in the Construction Standards.

**PAWNSHOPS:** A business dealing in or collecting used or secondhand merchandise of personal property, which has been legitimately obtained.

**PERMANENT:** Lasting or intended to last or remain unchanged indefinitely.

**PERSON:** An individual, individuals, corporation, partnership or incorporated association of individuals, such as a club. Also includes tenants in common, joint tenants, firms, limited partnerships or associations of individuals however styled or designated. Any use of the word person, as defined in this section, shall be deemed to include the singular or plural and each gender, as appropriate.

**PERSONAL SERVICES:** Establishments primarily involved in providing personal grooming and related services. This definition shall include barbershops, beauty parlors, tailors, massage services, but not laundries or dry cleaners.

**PET GROOMING:** The grooming of small pets, such as dogs and cats; provided, that no more than five (5) animals may be on the premises at one time and that no lodging of animals is allowed.

**PLANNING COMMISSION:** The Delta City Planning Commission.

**PLAT:** A map or other graphical representation of lands being laid out and prepared in accordance with Utah Code § 10-9a-603. See DCC 18.64, "General Development Standards".

**PRIMARY DWELLING:** Means a single-family that:

- A. is detached; and
- B. is occupied as the primary residence of the owner of record.

**PRELIMINARY PLAT:** The preliminary drawings of a proposed subdivision, specifying the layout, uses and restrictions.

**PRESCHOOL:** The education or teaching of children, including kindergarten preparation, music lessons, etc.

**PROPERTY:** Any parcel, lot or tract of land, including improvements thereon, in the possession of or owned by, or recorded as the real property of, the same person or persons.

**PROPERTY LINE:** The boundary line of a parcel or lot.

**PROPERTY LINE, FRONT:** That part of a parcel or lot, which abuts a street.

**PROTECTION STRIP:** A strip of land of less than the minimum depth required by this title for a building lot bordering the boundary of a subdivision or a street within the subdivision for the purpose of controlling the access of property owners abutting the subdivision to the street.

**PUBLIC HEARING:** A hearing at which members of the public are provided a reasonable opportunity to comment on the subject of the hearing.

**PUBLIC IMPROVEMENT:** Any building, water system, drainage ditch, roadway, parkway, sidewalk or other pedestrian way, tree, lawn, off street parking lot, space or structure, lot improvement, or other facility for which the City may ultimately assume responsibility, or which may affect a City improvement.

**PUBLIC MEETING:** A meeting that is required to be open to the public under Utah Code 52-4, Open and Public Meetings.

**PUBLIC RIGHT-OF-WAY:** An area of land that is legally described in a registered deed for the provision of public access. Features within public right-of-ways (public ways) include streets, sidewalks, bridges, curbs, gutters, culverts, drains, waterways and others that are legally dedicated and recorded for the use of the general public.

**PUBLIC SERVICE:** Uses, which may be housed in separate buildings, or which may occupy a space within a building, that are operated by a unit of government to serve public needs, such as police (with jail), fire service, ambulance, Post Office or judicial court, but not including public utility stations or maintenance facilities.

**PUBLIC STREET:** A street, including the entire right-of-way, which has been dedicated to and accepted by the City of Delta or other governmental agency or which has been devoted to public use by legal mapping, use or other means.

**PUBLIC UTILITIES, EXCEPT SEWER:** See public utility stations; excluding sewage installments and utilities.

**PUBLIC UTILITY STATIONS:** A structure or facility used by a public or quasi-public agency to store, distribute, generate or chemically treat water, power, gas, sewage, equipment or other service elements.

**REASONABLE NOTICE:** The requirements of reasonable notice are met if notice of hearing or meeting is posted in at least three (3) public places within the jurisdiction and/or notice of the hearing or meeting is published in a newspaper of general circulation in the jurisdiction, or if actual legal notice of the hearing or meeting is given.

**RECORD OF SURVEY MAP:** A graphic illustration of a survey of land prepared in accordance with State laws.

**RECREATIONAL VEHICLE:** A vehicular unit, other than a mobile home, primarily designed as a temporary dwelling for travel, recreational and vacation use, which is either self-propelled or is mounted on or pulled by another vehicle, including, but not limited to, a travel trailer, a camping trailer, a truck camper, a motor home, a fifth wheel trailer and a van.

**RECREATIONAL VEHICLE PARK (TRAVEL TRAILER PARK):** Any area or tract of land or separately designated section where lots are rented to one or more owners or users of recreational vehicles for a temporary time.

**RELIGIOUS, EDUCATIONAL INSTITUTE:** A 28 USC 501(c)(3) nonprofit organization engaged in teaching, community programs or spiritual endeavors, which qualifies as a tax exempt religious institution under title 28 of the U.S. Code.

**REPAIR SERVICES, SMALL APPLIANCE OR EQUIPMENT:** An establishment for the repair of household or other small appliances or equipment and at which no such appliances or their parts are stored out of doors.

**RESIDENTIAL FACILITY FOR THE DISABLED/RESIDENTIAL FACILITY FOR PERSONS WITH A DISABILITY:** A facility that is occupied by three (3) to five (5) unrelated persons with disabilities on a twenty four (24) hour per day basis in a family type arrangement under the supervision of a house family or manager, and that conforms to all applicable standards and requirements of and is licensed by the Utah Department of Human Services - Division of Services for People with Disabilities or Health, and is operated by or under contract with that department. Such facilities shall not include facilities for the following: secure treatment, inpatient treatment, residential treatment, adult daycare, day treatment, comprehensive mental health treatment, comprehensive substance abuse treatment, or domestic violence treatment as defined in Utah Code § 62A-2-101.

**RESIDENTIAL FACILITY FOR THE ELDERLY:** A long term care residential facility for elderly persons. The term does not include a healthcare facility.

**RESIDENTIAL SUPPORT:** Arranging for or providing the necessities of life as a protective service to individuals or families who are disabled or who are experiencing a dislocation or emergency which prevents them from providing these services for themselves or their families. Treatment is not a necessary component of residential support.

**RESIDENTIAL TREATMENT CENTER:** A twenty four (24) hour group living environment for three (3) to nine (9) individuals unrelated to the owner or provider that offers room or board and specialized treatment, rehabilitation or rehabilitation services for persons with emotional, psychological, developmental or behavioral dysfunctions or impairments. For the purposes of this section, residential treatment center shall not include facilities for comprehensive substance abuse treatment or domestic violence treatment as defined in Utah Code § 62A-2-101.

**RESOURCE FAMILY HOME:** A home licensed to provide services to a child in the custody of the State and includes a foster care home and a legal risk home.

**RESTAURANT, CAFE, CONFECTIONERY:** An establishment where food is prepared and served to customers for consumption on the premises.

**RESTAURANT, FAST FOOD, DRIVE-IN:** An establishment distinguished from a traditional sit down restaurant in that service is provided from a counter or window for consumption either off or on the premises; on premises consumption normally requires considerably less time than consumption in a traditional restaurant. Service may also be provided to customers in automobiles by use of an outside drive-up window; parking is provided immediately adjacent to the building. This definition includes also specialty food stores, such as ice cream parlors or delicatessens, having counter or window service.

**RESUBDIVISION:** A change in a map of an approved or recorded subdivision plat if such change affects any right-of-way or lot line; or any change in a map or plan legally recorded prior to the adoption of regulations controlling subdivisions.

**RIGHT-OF-WAY:** A strip of land, dedicated to public use, that is occupied or reserved to be occupied by a street, crosswalk, trail, stairway, railroad, road, utilities or for another special use.

**ROAD CLASSIFICATION:** The streets, highways, roads and rights-of-way designated on the Streets Master Plan.

**ROAD, RIGHT-OF-WAY WIDTH:** The distance between property lines measured at right angles to the centerline of the street.

**ROOF:** The building element, which covers the top of the structure as the walls enclose the sides.

**SANITARY SEWER AUTHORITY:** The department, agency or public entity with responsibility to review and approve the feasibility of sanitary sewer services or on site wastewater systems.

**SATELLITE RECEIVING STATION:** Any apparatus or device designed for the purpose of transmitting and/or receiving radio, television, satellite microwave, or other electromagnetic energy signals between terrestrially and/or orbital based uses. This definition includes, but is not limited to, what are commonly referred to as satellite earth stations, satellite microwave antennas, TVROs or dish antennas. This definition does not include conventional television antennae.

**SCHOOL, PRIVATE OR QUASI-PUBLIC:** A school operated by a private or quasi-public organization or individual, which has a program similar to that provided in any public school in the State of Utah, except that such curriculum may include religious instruction. A private school may be a profit making or nonprofit organization. This definition shall not include commercial schools.

**SCHOOL, PRIVATE, QUASI-PUBLIC (40' FROM ALL PROPERTY LINES, NO RESIDENCE WITHIN):** See schools, private, quasi-public. The building must be forty feet (40') from all property lines, no residence within.

**SCHOOL, PUBLIC:** An educational facility operated by a school district or other public agency of the State of Utah.

**SCHOOL, PUBLIC (40' FROM ALL PROPERTY LINES, NO RESIDENCE WITHIN):** See school, public. The building must be forty feet (40') from all property lines, no residence within.

**SCREEN OR SCREENED:** The act, process or result of visually and/or audibly shielding or obscuring a structure or use from adjacent property by fencing, walls, berms, densely planted vegetation or other features.

**SECURE TREATMENT:** Twenty four (24) hour specialized residential treatment or care for persons whose current functioning is such that they cannot live independently or in a less restrictive environment. Secure treatment differs from residential treatment to the extent that it requires intensive supervision, locked doors and other security measures which are imposed on residents with neither their consent nor control.

**SENIOR CITIZEN CENTER:** A government sponsored public building, other than a church or school, serving the social and recreational needs of the elderly. Such a center may include a meeting hall and cooking and dining facilities for large groups, but shall not provide overnight lodging.

**SETBACK:** The required minimum distance between a building or structure and the closest of the following: property line; platted street; or existing curb or edge of a street.

**SHOPPING CENTER, COMMUNITY (RETAIL BUSINESS):** A completely planned and designed commercial development providing for the sale of general merchandise and convenience goods and including a variety store, discount store or supermarket.

**SHOPPING CENTER, NEIGHBORHOOD:** A planned commercial development providing primarily for the sale of convenience goods and services. The center is designed to serve a residential neighborhood.

**SIGHT DISTANCE TRIANGLE:** A triangular area at the intersection of two (2) streets bounded by property lines connecting them at points thirty five feet (35') from the intersection of the two (2) adjoining property lines, which is to be kept reasonably clear to allow for the unimpeded view of drivers or pedestrians approaching the intersection.

TYPICAL SITE TRIANGLE AREA GUIDE

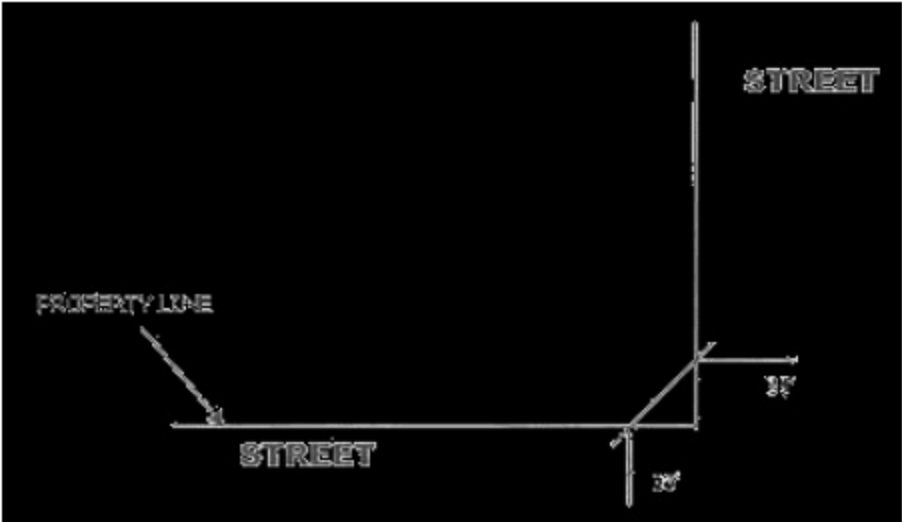

**SIGNIFICANT VEGETATION:** Includes all large trees six inches (6") in diameter or greater measured four and one-half feet (4 1/2') above the ground, all groves of small trees, and all clumps of oak or maple covering an area fifty (50) square feet or more measured at the drip line.

**SIGNS:** A presentation of words, letters, figures, designs, pictures or colors publicly displayed so as to give notice relative to a person, a business, an article or merchandise, a service, an assemblage, a solicitation or a request for aid; also the structure or framework or any natural object on which any sign is erected or is intended to be erected or exhibited or which is being used or is intended to be used for sign purposes.

- A. **Abandoned Sign:** Any sign which is obsolete or which has not been properly maintained for a period of three months, at which time such a sign can be removed by the City and a removal fee charged to the owner.
- B. **Billboard:** A freestanding ground sign located on industrial, commercial or residential property if the sign is designed or intended to direct attention to a business, product or service that is not sold, offered or existing on the property where the sign is located. For purposes of this definition, a billboard shall be considered to be an off premises sign.
- C. **Convert:** To change a billboard sign face from its existing, non-digital surface to a digitally controlled surface.
- D. **Directional Signs:** Signs containing information about public places owned or operated by Federal, State or local governments or their agencies, publicly or privately owned, natural phenomena, historic, cultural, scientific, educational or religious sites and areas of natural scenic beauty or naturally suited for outdoor recreation.
- E. **Erect:**
  - 1. To construct, build, raise, assemble, place, affix, attach, create, paint, draw or in any other way bring into being;
  - 2. Erect does not include any activities defined in paragraph A if they are performed incident to the change of an advertising message or customary maintenance of a sign.
- F. **Maintain Or Maintenance:** To repair, refurbish, repaint or otherwise keep an existing sign structure safe and in a state suitable for use, including signs destroyed by vandalism or by acts of God. Owner or lessee of a sign may repaint, redecorate and/or change letters or panels on his/her own sign.
- G. **Off Premises Signs:** A sign that advertises, communicates or identifies products, services, businesses, organizations, activities or messages that are not located, conducted, manufactured or sold on the premises where the sign is displayed. Off-premises signs generally include billboards and other similar signs.
- H. **Official Signs And Notices:** Signs and notices erected and maintained by Delta City within its territorial or zoning jurisdiction for the purpose of carrying out official duties or responsibilities in accordance with direction and authorization contained in Federal, State or local law.
- I. **On Premises Signs:** Signs which advertise or direct attention to a commercial building or a use conducted, a commodity sold or a service performed on the premises where



the sign is located.

- J. Sign Setback: The minimum distance that any portion of a sign or sign structure shall be from any street property line.

**SITE DEVELOPMENT STANDARDS:** Regulations unique to each zone concerning standards for development, including, but not limited to, lot areas, setbacks and building height.

**SKATING - ROLLERBOARD PARK:** Any facility, structure or area in which skateboarding, in-line skating, or bicycle riding is allowed, which is owned, operated and maintained by the City, and which has been designated as a "skating-rollerboard park" by ordinance of the City Council.

**SLOPE:** The level of inclination of land from the horizontal plane determined by dividing the horizontal run, or distance, of the land into the vertical rise, or distance, of the same land and converting the resulting figure to a percentage value.

**SMALL ENGINE REPAIR:** An establishment engaged in the repair and maintenance of small engines with an engine displacement size no greater than two thousand (2,000) cc. This includes, but is not limited to: motorcycles, OHVs, ATVs, home and garden tools and equipment, outboard motor watercraft (engine removed), snowmobiles, chainsaws and other similar small engines.

**SOLAR ENERGY SYSTEM:** A system of apparatus and equipment capable of collecting and converting solar radiation into heat, mechanical or electrical energy, and transferring those forms of energy by a separate apparatus to storage or to point of use, including, but not limited to, water heating, space heating or cooling, electric energy generation or mechanical energy generation.

**SOLICITING OR SOLICIT OR SOLICITATION:** Any of the following activities:

- A. Seeking to obtain sales or orders for the exchange of goods, wares, merchandise or perishables of any kind, for any kind of remuneration or consideration, regardless of whether advance payment is sought.
- B. Seeking to obtain prospective customers to apply for or to purchase insurance, subscriptions to publications, or publications.
- C. Seeking to obtain contributions of money or any other thing of value for the benefit of any person or entity.
- D. Seeking to obtain orders or prospective customers for goods or services.
- E. Seeking to engage an individual in conversation at a residence for the purpose of promoting or facilitating the receipt of information regarding charitable conduct, or a home solicitation sale.
- F. Other activities falling within the commonly accepted definition of "soliciting", such as hawking or peddling.
- G. This section shall not be construed to disallow the proselytizing of religious or charitable groups.

**SOLICITORS:** Persons engaged in door-to-door solicitation.

**SPECIAL DISTRICT:** An entity established under the authority of Utah Code 17A, Special Districts, and any other governmental or quasi-governmental entity that is not a county, municipality, school district or unit of the State.

**STABLE, PRIVATE:** A detached accessory structure used for the keeping and housing of livestock by the occupants of the premises.

**STABLES, PRIVATE (PROVIDED STRUCTURES HOUSING ANIMALS SHALL NOT BE CLOSER THAN 200' TO ANY PROPERTY LINE):** See definition of stable, private. No part of the structures may be closer than two-hundred feet (200') to any property line.

**STABLE, PUBLIC:** A stable other than a private stable.

**STABLES, PUBLIC (PROVIDED STRUCTURES HOUSING ANIMALS SHALL NOT BE CLOSER THAT 200' TO ANY PROPERTY LINE):** See definition of stable, public. No part of the structures may be closer than two-hundred feet (200') to any property line.

**STABLES, PUBLIC/ COMMERCIAL:** A building in which domestic animals, such as horses, ponies, and cattle, are sheltered and fed, having stalls or compartments. Animals may be boarded for profit.

**STEALTH TELECOMMUNICATIONS FACILITY:** A telecommunications facility, which is disguised as another object or otherwise concealed from public view.

**STORAGE LAND SEA CONTAINERS or CARGO STORAGE CONTAINER:** An all steel container (some with wooden floors) and strength to withstand shipment, storage and handling. Such containers include reusable steel boxes, freight containers, enclosed highway tractor trailers, and bulk shipping containers; originally a standardized reusable vessel that was designed for and used in the parking, shipping, movement, transportation or storage of freight, articles or goods or commodities; generally capable of being mounted or moved on a rail car, truck trailer or loaded on a ship.

**STORAGE UNIT, PUBLIC/ COMMERCIAL:** A building or series of buildings in which spaces are rented, leased, or sold for the purpose of storage. Spaces shall be individually secured and enclosed.

**STORY:** A habitable level within a building serving to define the building height. Basements that emerge less than four feet (4') from grade or attics not exceeding four feet (4') at the kick wall shall not constitute an additional story.

**STORY, HALF:** A story with at least two (2) of its opposite sides situated in a sloping roof, the floor area of which does not exceed two-thirds (2/3) of the floor immediately below it.

**STREAM:** A naturally fed watercourse, that flows year-round or intermittently during years of normal rainfall. This definition excludes ditches and canals constructed for irrigation and drainage purposes.

**STREAM CORRIDOR:** The corridor defined by the stream's ordinary high water mark.

**STREET:** A private or public right-of-way, including a highway, avenue, boulevard, parkway, road, lane, walk, alley, viaduct, subway, tunnel, bridge, public easement or other way. Also includes a thoroughfare which has been dedicated and accepted by the City Council, which Delta City has acquired by prescriptive right or which Delta City owns, or which has been offered for dedication on an approved final plat, or a thoroughfare of at least thirty three feet (33') in width which has been abandoned or made public by right of use and which affords access to abutting property, including highways, roads, lanes, avenues and boulevards.

**STREET, ACCESS:** A street that serves a small number of dwellings and usually does not allow through traffic. Usual ADT (average daily traffic) range is zero to two hundred fifty (250) vehicles.

**STREET, ARTERIAL:** A street which provides for through traffic movement between areas and across the City, with moderate access to abutting property subject to necessary control of entrances, exits and curb use, and also provides access to highways. Arterials are not usually included in residential street plans. Maximum ADT is three thousand plus (3,000+) vehicles.

**STREET, COLLECTOR:** A street that provides for a high volume of traffic movement between major arterials and local streets, and direct access to abutting property. Usual ADT range is one thousand (1,000) to three thousand (3,000) vehicles.

**STREET, LOCAL:** A street that provides for direct access to abutting land and for local traffic movements.

**STREET, PRIVATE:** A right-of-way or easement in private ownership, not dedicated or maintained as a public street, which affords the principal means of access to two (2) or more lots.

**STREET, PUBLIC:** A street that has been dedicated to and accepted by the City Council; that the City has acquired and accepted by prescriptive right; or that the City owns in fee. A public thoroughfare, which affords principal means of access to abutting property and has a right-of-way that exceeds twenty six feet (26') in width. The term street shall include avenue, drive, circle, road, parkway, boulevard, highway, thoroughfare or any other similar term.

**STREET, SUBCOLLECTOR:** A street which conveys traffic to more dwellings and includes through traffic between access streets and collectors. Usual ADT range is two hundred fifty (250) to one thousand (1,000) vehicles.

**STREETSCAPE:** The distinguishing characteristics of a particular street, including paving materials, adjacent space on both sides of the street, landscaping, retaining walls, sidewalks, building facades, lighting, medians, street furniture and signs.

**STRUCTURAL ALTERATIONS:** Any change in the supporting members of a building, such as bearing walls, columns, beams or girders.

**STRUCTURE:** Anything constructed, the use of which requires a fixed location on or in the ground, or attached to something having a fixed location on the ground and which imposes an impervious material on or above the ground; definition includes "building".

**STRUCTURE, PRE-EXISTING:** A structure, which was legally constructed prior to August 16, 2012.

**SUBDIVISION:**

- A. Any land that is divided, resubdivided or proposed to be divided into two (2) or more lots, parcels, sites, units, plots or other division of land for the purpose, whether immediate or future, for offer, sale, lease or development, either on the installment plan or upon any and all other plans, terms and conditions. Subdivision includes: 1) the division or development of land, whether by deed, metes and bounds description, devise and testacy, map, plat or other recorded instrument; and 2) divisions of land for residential and nonresidential uses, including land used or to be used for commercial, agricultural and industrial purposes.
- B. Subdivision does not include:
  - 1. A bona fide division or partition of agricultural land for the purpose of joining one of the resulting separate parcels to a contiguous parcel of unsubdivided agricultural land, if neither the resulting combined parcel nor the parcel remaining from the division or partition violates an applicable zoning ordinance;
  - 2. A "lot line adjustment" that satisfies the applicable requirements of this title.
  - 3. A recorded document, executed by the owner of record, revising the legal description of more than one contiguous parcel of property into one legal description encompassing all such parcels of property, or joining a subdivided parcel of property to another parcel of property that has not been subdivided, so long as the joinder does not violate this title.

**SUBDIVISION PLAT:** The final map or drawing, on which the applicant's plan of subdivision is presented to the City Council for approval and which, if approved, may be submitted to the County Recorder for filing.

**SUBDIVISION, SIMPLE LOT:** Any subdivision containing not more than three (3) lots fronting on an existing street, not involving any new street, or the extension of Municipal facilities, or the creation of any public improvements, and not adversely affecting the remainder of the parcel or adjoining property, and not in conflict with any provision or portion of the General Plan, Official Land Use Map, Street Master Plan or these regulations. Subdivisions qualifying as a simple lot subdivision are exempt from the plat requirement.

**SURPLUS, SECONDHAND STORE:** An establishment that sells surplus items, used furniture, appliances, clothing and miscellaneous small items. Excluded from this definition are establishments selling used motor vehicles, their parts, military surplus and other heavy equipment.

**TECHNICAL NECESSITY:** A particular design, placement, construction or location of a telecommunications facility that is technically necessary for telecommunications consistent with the Federal Telecommunications Act of 1996, as amended.

**TELECOMMUNICATIONS:** The transmission, between or among points specified by a user, of information of the user's choosing, without change in the form or content of the information as sent or received.

**TELECOMMUNICATIONS FACILITY:** A telecommunications facility of more than thirty five feet (35') in height consisting of antenna, equipment shelters and related structures used for transmitting and/or receiving telecommunications and/or radio stations.

**TEMPORARY OUTDOOR USE:** A use, activity, vending cart, special event or commercial use outside that is not permanent in nature and after a seventy two (72) hour time period ceases or is removed.

**TEMPORARY USE:** A use, activity or special event that is not permanent in nature and after a designated time period ceases or is removed.

**THEATER, CONCERT HALL:** A building or amphitheater used primarily for the presentation of live stage productions or performances.

**TOBACCO/ELECTRONIC CIGARETTE (E-CIGARETTE) PRODUCT:**

- A. Any cigar, cigarette or electronic cigarette as defined in Utah Code § 76-10-101, as amended;
- B. A tobacco product as defined in Utah Code § 59-14-102, as amended, including:
  1. Chewing tobacco; or
  2. Any substitute for a tobacco product, including flavoring or additives to tobacco; and
- C. Tobacco paraphernalia as defined in Utah Code § 76-10-101 as amended.

**TOBACCO SPECIALTY BUSINESS, RETAIL:** A commercial establishment in which:

- A. The sale of tobacco products accounts for more than thirty five percent (35%) of the total annual gross receipts for the establishment;
- B. Food and beverage products, excluding gasoline sales, is less than forty five percent (45%) of the total annual gross receipts for the establishment;
- C. The establishment is not licensed as a pharmacy under Utah Code 58-17b, Pharmacy Practice Act; or Devotes twenty percent (20%) or more of floor area or display area to the sale or exchange of tobacco products and/or tobacco/e-cigarette paraphernalia;
- D. And as further defined by Utah Code § 10-8-41.6, as amended.

TRAILER, TRAVEL: See definition of recreational vehicle.

TRANSFER STATION: A facility designed for the transfer and transport of solid waste.

TRAVEL PARK: See definition of recreational vehicle park.

UNINCORPORATED: The area outside of the incorporated boundaries of cities and towns.

USE: The activities occurring on a lot or parcel of land for which land or a building is arranged, designed or intended, or for which land or a building is or may be occupied, including all accessory uses.

USE, PRE-EXISTING: A use, which validly existed prior to August 16, 2012, and has not been abandoned for more than six (6) months.

UTILITIES: Includes culinary water lines, pressure and gravity irrigation lines, sanitary and storm sewer lines, electric power, gas and telephone transmission lines, television cables, underground conduits and junction boxes.

VENDING CART: A small wheeled, nonmotorized vehicle from which to sell food and/or merchandise for immediate consumption or use.

WAREHOUSE, COMMERCIAL: An establishment primarily engaged in the storage and sale of goods to other firms for resale, as well as activities involving movement and storage of products or equipment. Typical uses include mail distribution centers, moving and storage firms, and warehousing and storage facilities.

WELDING MACHINE SHOP: A building or structure where pieces of metal are welded.

YARD: An open space on a lot, unoccupied and unobstructed from the ground upward.

YARD, FRONT: An open, unoccupied space, in the same lot with a building, between the front line of the main building and the street line and extending for the full width of the lot.

YARD, REAR: A yard extending across the full width of the lot between the most rear main building and the rear lot line. The depth of the required rear yard shall be measured horizontally from the nearest point of the rear lot line. On lots that are not rectangular in shape, the required minimum rear yard may be an average of the distances measured from the rear corners of the main building directly to the rear lot line.

YARD, SIDE: An open, unoccupied space, except as otherwise provided in this title, on the same lot with the building, between the side building wall and the side lot line, and extending from the front yard to the rear yard; or the shortest distance across said space from the main building to the side lot line.

YOUTH HOME: A twenty four (24) hour group living environment for three (3) to five (5) persons under the age of eighteen (18), unrelated to an owner or operator that offers room, board or specialized services to residents. Youth home may include facilities for the following: resource family home, child placement or residential support as defined in Utah Code 62A. Youth home shall not include facilities for the following: secure treatment, inpatient treatment, residential treatment, adult daycare, day treatment, comprehensive mental health treatment, youth program, comprehensive substance abuse treatment, or domestic violence treatment as defined in Utah Code 62A.

YOUTH PROGRAM:

- A. A nonresidential program, designed to provide behavioral, substance abuse or mental health services to minors that:
  - 1. Serves either adjudicated or nonadjudicated youth;
  - 2. Charges a fee for its services;
  - 3. May or may not provide host homes or other arrangements for overnight accommodation of the youth;
  - 4. May or may not provide all or part of its services in the outdoors;
  - 5. May or may not limit or censor access to parents or guardians; and
  - 6. Prohibits or restricts a minor's ability to leave the program at any time of his own free will.
- B. Youth program does not include recreational programs, such as Boy Scouts, Girl Scouts, 4-H and other such organizations.

ZONING MAP: A map, also known as a land use map, adopted as part of a land use ordinance that depicts land use zones, overlays or districts. (Ord. 18-277, 2-15-2018; amd. 2019 Code)

AFTER AMENDMENT

18.04.010 DEFINITIONS

For the purpose of this title, certain numbers, abbreviations, terms and words shall be used, interpreted and defined as set forth herein. Words not defined herein shall have a meaning consistent with Webster's New Collegiate Dictionary, latest edition. Unless the context clearly indicates to the contrary, words used in the present tense include the future tense; words used in the plural number include the singular; the word "herein" means "in these regulations"; the word "regulations" means "these regulations"; "used" or "occupied", as applied to any land or building, shall be construed to include the words "intended, arranged or designed to be used or occupied".

ACCESSORY BUILDING, LARGE: An accessory building larger than six hundred (600) square feet that is located on the same lot as a residence.

ACCESSORY DWELLING UNIT: A building on the same lot as the principal building and that is:

- A. Clearly incidental to, and customarily found in connection with, such principal building;
- B. Operated and maintained for the benefit of the principal use; and
- C. A dwelling unit or home office.

Also includes the following:

1. "Accessory Apartment" means a housing unit which is self-contained but incorporated within the footprint of the primary dwelling as at the time the internal accessory dwelling unit is created and will not substantially alter the structure or the appearance of the structure. An accessory apartment is a complete, separate housing unit that shall be within the original dwelling unit.
2. "Guesthouse" means a detached living quarters located within an accessory building that is subordinate to, and located on the same premises with, a primary dwelling, occupied solely by members of the family and temporary guests. Such facilities shall not be rented independently from the main dwelling unit.

**ACCESSORY BUILDING, UNOCCUPIED:** A building on the same lot as the principal building and that is:

- A. Clearly incidental to, and customarily found in connection with, such principal building;
- B. Operated and maintained for the benefit of the principal use; and
- C. Not a dwelling unit.

**ACCESSORY LIVING QUARTERS:** Accessory dwelling incidental to a church or airport.

**ACCESSORY USE OR BUILDING:** A subordinate use or building customarily incidental to and located upon the same lot occupied by the main use or building.

**ACTIVE BUILDING PERMIT:** An unexpired and unrevoked building permit for which the building inspector has not performed a final inspection and has not issued a certificate of occupancy.

**ADULT ORIENTED BUSINESSES:** Any or all of the following or any portions of the following: adult book store, adult video store, adult novelty store, adult motion picture theater, adult theater and tattoo parlors.

**AFFECTED ENTITY:** A county, municipality, local district under Utah Code 17B-1, Local Districts, school district, interlocal cooperation entity established under Utah Code 11-13, Interlocal Cooperation Act, a property owner, a property owner association, specified public utility, or the Utah Department of Transportation, if:

- A. The entity's services or facilities are likely to require expansion or significant modification because of an intended use of land;



- B. The entity has filed with the Municipality a copy of the entity's general or long range plan; or
- C. The entity has filed with the Delta City Recorder a request for notice during the same calendar year.

**AGRICULTURAL INDUSTRY OR BUSINESS:** An industry or business involving agricultural products in manufacturing, packaging, treatment, sales or storage, including, but not limited to, food packaging or processing plants, and similar uses. This definition does not include hog farms, commercial poultry businesses or rendering facilities.

**AGRICULTURE:** The tilling of soil, raising of crops, horticulture, gardening and other similar uses.

**AGRICULTURE (IF LOT IS 1 OR GREATER):** See definition of agriculture. Lot must be greater than or equal to one (1) acre in size.

**ALTERATIONS, STRUCTURAL:** Any change in the supporting members of a building, such as bearing walls, columns, beams or girders.

**ANIMAL HOSPITAL OR VETERINARY OFFICES:** An establishment where animals are medically treated, lodged or trained by a licensed veterinarian.

**ANIMAL WASTE:** The excrement and discharge from an animal, or animal carcasses, tissues or any other substance or material capable of transmitting disease or disease carrying agents.

**ANTENNA:** A transmitting or receiving device used in telecommunications that radiates or captures radio, television or similar communication signals.

**ANTENNA, FREESTANDING:** An antenna mounted on the roof of or within a stand alone support structure, including, but not limited to, a wooden pole, steel pole, lattice tower, utility pole, lift tower, light standard, flag pole or other vertical support.

**ANTENNA, ROOF MOUNTED:** An antenna or series of individual antennas mounted on the roof of a building.

**ANTENNA, TEMPORARY:** An antenna used for a time period of less than thirty (30) days.

**ANTENNA, WALL MOUNTED:** An antenna or series of individual antennas mounted fully against the exterior face of a building including on the face of a chimney. A wall or face of a building is defined as the entire area of all exposed vertical surfaces of a building that are aboveground and facing approximately the same direction.

**ANTENNA, WHIP:** An antenna that is cylindrical in shape. Whip antennas can be directional or omni-directional and vary in size depending upon the frequency and gain for which they are designed.

**APPEAL AUTHORITY:** An individual or group of individuals appointed by the City Council through resolution, or, in the event of no such appointment being made, a board made up of the Delta City Council as provided in this title.

**APPLICANT:** An owner, occupant or authorized agent, or a contractor or person with control of the property or lot that is the subject of the application.

**APPLICATION:** A written request for development approval, including, but not limited to, an alteration or revision to an approved master planned development, zoning or rezoning, subdivision or annexation. The term "application" shall not include any building permits associated with construction within an approved subdivision or on an existing platted lot unless otherwise specified.

**ASSEMBLY FACILITY:** A facility where parts are put together to develop a final product. Generally referring to automobile, computer and electronic assembly.

**ASSISTED LIVING CENTER:** Residences that provide for semi-independent living. Such facilities may be: a) equipped with a studio or one bedroom apartments with limited kitchen facilities, generally designed for single occupancy; b) contain central dining facilities where prepared meals are served to the residents; c) employ full time nursing or medical assistance and supervision; and d) may provide other additional services to residents.

**ATHLETIC CLUB:** An establishment providing facilities for physical development exercise, sports or recreation. Facilities may include exercise equipment, indoor and/or outdoor racquetball or tennis courts, jogging track, swimming pools, ice skating rink, indoor bathing, restaurant or snack bar, and sales of athletic equipment. Facilities may be open to the public for a fee, or available only to persons holding membership.

**ATTORNEY:** The person, or persons, appointed by the City Council, to be the Delta City Attorney.

**AUTO, TRUCK, RECREATIONAL VEHICLE AND EQUIPMENT SALES AND RENTAL:** Sales of both new and used motor vehicles and equipment stored and displayed both indoors and on outside lots, but not to include nonserviceable or junk vehicles or equipment.

**AUTO WRECKING, SALVAGE YARD:** The use of any lot, portion of lot or tract of land for the storage and keeping of salvage, including scrap metals or other scrap material, unlicensed/inoperable vehicles, or for the dismantling or demolition of obsolete automobiles or equipment machinery, or parts thereof. This definition shall not be deemed to include such uses which are clearly accessory and incidental to any agricultural use permitted in the zone district.

**AUTOMOTIVE BODY/PAINT REPAIR ESTABLISHMENT:** All buildings, structures, and premises where motor vehicles are stored, rented or sold, or where motor vehicles are repaired, oiled, greased, adjusted or worked upon in any manner whatsoever and for which a charge is made.

**AUTOMOTIVE REPAIR ESTABLISHMENT:** An establishment primarily engaged in the repair or maintenance of motor vehicles, trailers and similar large mechanical equipment.

**AUTOMOTIVE SELF-SERVICE STATION:** An establishment for the retail sale of automobile fuels and lubricants, at which the customer provides the service to his own vehicle, and at which no vehicle repair or maintenance service is offered. Such an establishment may offer for sale at retail other convenience items as a clearly secondary activity. Stations located at interstate exchanges catering to semi-trucks, which also include accommodations for truckers, also known as truck stops.

**AUTOMOTIVE SERVICE STATION:** An establishment whose primary purpose is the retail sale of gasoline or other motor vehicle and related fuel, oil or lubricant. Secondary activities may include minor automotive repair, maintenance or automatic car wash.

**AVIATION AIRPORT - ACCESSORY LIVING QUARTERS:** The same as accessory building, occupied; built and maintained by or at the Delta City Airport.

**AVIATION AIRPORT SERVICES:** Area containing an aviation landing strip, runway, hangar or other related services needed for aircraft.

**BALCONY:** A platform that projects from the wall of a building and is enclosed by a railing, parapet or balustrade.

**BANKING OR FINANCIAL SERVICE:** A bank, credit union, savings and loan association, or other establishment with a primary purpose of receiving, lending, exchanging or safeguarding money, or performing financial advisory service. This definition shall include outside drive-up facilities for service to customers in automobiles.

**BAR, TAVERN, LOUNGE AND CLUB:** An establishment intended primarily for the on premises sale and consumption of alcoholic beverages, open either to the public or operated as a nonprofit private club for members only.

**BASEMENT:** A story whose floor is more than twelve inches (12") below the average level of the adjoining ground, but where no more than half of its floor to ceiling height is below the average contact level of the adjoining ground. A basement shall be counted as a story for purposes of height measurement and as a half-story for purposes of side yard determination.

**BED AND BREAKFAST:** A building where, for compensation, meals and lodging are provided for at least five (5) but not more than fifteen (15) persons.

**BOND, PUBLIC IMPROVEMENT:** A one year guarantee to the City that all public improvements have been installed to City specifications and will operate properly.

**BUILDING:** Any structure, whether temporary or permanent, having a roof, and used or built for the shelter or enclosure of persons, animals, possessions or property of any kind.

**BUILDING AREA:** The portion of a lot that is within the envelope formed by the required yards or setbacks, within which a structure can be located.

**BUILDING HEIGHT:** The vertical distance from the average finished grade surface at the building wall to the highest point of the coping of a flat roof or to the deck line of a mansard roof, or the mean height level between eaves and ridge for gable, hip or gambrel roofs.

**BUILDING INSPECTOR:** Delta City official known as the Construction Enforcement Officer who is designated to inspect buildings under construction and upon completion.

**BUILDING, MAIN:** A building within which the principal land use of the lot is conducted.

**BUSINESS:** Any activity carried on for the purpose of gain or economic profit. The acts of employees rendering service to employers are not included in the term business unless otherwise specifically prescribed. Business includes, but is not limited to, the sale or rental of tangible personal or real property, the manufacturing of goods or property and the rendering of personal services for others for consideration by persons engaged in any profession, trade, craft, occupation, nonprofit organization or other calling.

**BUSINESS, COMMERCIAL, LESS INTENSIVE:** A business that does not include automotive, heavy equipment or twenty four (24) hour uses. May be with or without a drive up window.

**CANOPY:** A roof or awning constructed of fabric or other material and extending outward from a building to provide a protective shield for doors, windows or other openings with supports extended to the ground directly under the canopy or cantilevered from the building.

**CARPOR:** A roofed structure, open on at least three (3) sides, designed for or occupied by private passenger vehicles. Except for in the case of a permitted encroachment pursuant to DCC 18.64.070 paragraph B, for the purposes of this title, a carport shall be subject to all regulations prescribed for a private garage.

**CEMETERY, COLUMBARIUM, CREMATORY, MAUSOLEUM:** Land or buildings used for the cremation, burial or interment of the human dead, but not including facilities for embalming.

**CHIEF EXECUTIVE OFFICER:** The Mayor of Delta City.

**CHILD PLACING:** Receiving, accepting or providing custody or care for any child under eighteen (18) years of age, temporarily or permanently, for the purpose of: finding a person to adopt the child; placing the child temporarily or permanently in a home for adoption; or foster home placement.

**CHILDCARE CENTER:** The provision of childcare for business for eight (8) or fewer children, including the provider's children who are under the age of eighteen (18), within a dwelling unit.

**CHILDCARE FACILITY:** The provision of childcare for business for nine (9) or more children, including the provider's children who are under the age of eighteen (18).

**CHURCH:** A building set apart primarily for the purpose of worship in which religious services are held and with which clergy is associated, the main body of which is kept for that use and not put to any other use inconsistent with its primary purpose, and which is tax exempt under the laws of the State of Utah.

**CHURCH, ACCESSORY LIVING QUARTERS:** See accessory building, occupied; built and maintained by the religious organization. **CHURCH (FORTY FEET (40') FROM ALL PROPERTY LINES, NO RESIDENCE WITHIN):** See definition of church. The building must be forty feet (40') from all property lines, no residence within.

**CINEMA, INDOOR:** An enclosed building used primarily for the presentation of motion pictures.

**CINEMA, OUTDOOR:** An establishment at which motion pictures are projected onto an outdoor screen for viewing by patrons seated in parked motor vehicles.

**CITY COUNCIL:** The Governing Body of Delta City.

**CIVIC CLUB, FRATERNAL ORGANIZATION:** A building or use, other than a church or school, operated by a nonprofit association or organization for a social, fraternal, political, civic or philanthropic purpose, which may include a meeting hall and cooking and dining facilities for large groups, but shall not provide overnight lodging.

**CLEAR VISION AREA:** An area outlined by the sight distance triangle where solid fencing or natural vegetation is restricted to a height of three feet (3') and where all structures or other items that would obstruct vision are prohibited. See definition of sight distance triangle.

**CLUB, PRIVATE:** Any nonprofit corporation or organization, operating as a social club, recreational, fraternal, athletic or kindred association organized primarily for the benefit of its stockholders or members and serving alcoholic beverages and/or food.

**COAL YARD:** The storage of coal in quantities in excess of ten (10) tons and/or the retail or wholesale sale of coal.

**CODE ENFORCEMENT OFFICER:** The Delta City official known as the Zoning and Land Use Enforcement Officer. The Code Enforcement Officer shall be one and the same as any reference in any Delta City ordinance, resolution or policy that references a "Zoning Officer", "Land Use Administrator", or any other title of a public official with duties regarding zoning and land use enforcement and shall have any and all discretion, duties and responsibilities as set out in such Delta City ordinance, resolution or policy.

**COLLECTOR STREET:** See definition of street, collector.

**COLLOCATION:** The location of a telecommunication facility on an existing structure, tower or building in a manner that precludes the need for that telecommunications facility to be located on a freestanding structure of its own.

**COMPLETE APPLICATION:** A submission, which includes all information requested on the appropriate form, and full payment of all applicable fees.

**CONGREGATE LIVING FACILITY:** A residence in which three (3) or more persons unrelated to the owner or provider reside, including, but not limited to, youth homes, residential facilities for the disabled or residential facilities for the elderly.

**CONSERVATION EASEMENT:** An easement designed to restore, enhance, protect and sustain the quality and quantity of ecosystems and natural resources.

**CONSTITUTIONAL TAKING:** Final action by the City to physically take or exact private real property that requires compensation to the owner because of the mandates of the Fifth or Fourteenth Amendments to the Constitution of the United States, or article I, section 22, of the Utah Constitution.

**CONSTRUCTION STANDARDS:** The standards and specifications set out in this title or maintained by the City.

**CONVENIENCE GOODS SALES AND SERVICES:** Stores or shops intended for retail sales of convenience goods or performance of convenience services. Goods and services regarded as convenience are those generally needed for daily home consumption and for which locations near residential neighborhoods are considered desirable. This category includes grocery store, drug store, variety store, personal service, hardware store, dry cleaning pick up and uses considered similar and compatible.

**COUNCIL:** Members of the City Council of Delta.

**COUNTY:** The unincorporated area of Millard County.

**COURT:** An open, unoccupied space, other than a yard, on the same lot with a building or group of buildings and which is bounded on two (2) or more sides by such building or buildings.

**COVERAGE:** The percent of the total site area covered by structures or impervious paving other than those accepted in this title.

**CUL-DE-SAC:** A minor street having an open end and being terminated at the other end by a vehicle turnaround.

**CULINARY WATER AUTHORITY:** The department, agency or public entity with responsibility to review and approve the feasibility of the culinary water system and sources for the subject property.

**CULTURAL, CIVIC SERVICES:** A building primarily used for the public, nonprofit display of art, historic or cultural artifacts, or other inanimate exhibits or a building primarily used as a lending library or reading room.

**DAIRY:** A commercial establishment housing animals for the processing and/or retail sale of dairy products.

**DELTA CITY CONSOLIDATED FEE SCHEDULE (OR FEE SCHEDULE):** A document adopted by resolution of the Delta City Council listing fees charged by Delta City to offset regulatory and administrative service costs of Delta City.

**DEVELOPMENT:** The act, process or result of erecting, placing, constructing, remodeling, converting, altering, relocating or demolishing any structure or improvement to property, including grading, clearing, grubbing, mining, excavating or filling of such property. This definition includes construction activity.

**DISABILITY:** A physical or mental impairment that substantially limits one or more of a person's major life activities, including a person having a record of such an impairment or being regarded as having such an impairment. Disability does not include current illegal use of, or addiction to, any Federally controlled substance, as defined in section 102 of the Controlled Substances Act, 21 USC 802.

**DISABLED CARE:** A long term care residential facility for disabled persons or persons suffering from a physical or mental impairment that substantially limits one or more of a person's major life activities, including a person having a record of such impairment or being regarded as having such impairment.

**DISTRICT:** A portion of the area of Delta City, Utah, shown on a zoning map (attached to the ordinance codified herein) and given a zone classification as set forth in this title.

**DRIVE TEST, ANTENNA:** A temporary antenna, which is used for field testing of telecommunications signals and possible locations, but does not provide telecommunications to customers.

**DRY CLEANING ESTABLISHMENT:** An establishment employing volatile or explosive substances for the cleaning or dyeing of fabrics. Excluded from this definition are traditional laundries employing water and soaps in the cleaning of fabrics and patron operated dry cleaning machines associated with laundromats.

**DWELLING:** Any building, or portion thereof, which is designed for use for residential purposes of one family or individual with suitable approved provisions for eating, sleeping, cooking, and sanitation, except to not include hotels, boarding houses, lodging houses and tourist cabins.

**DWELLING, FOUR-FAMILY:** A building arranged or designed to be occupied by four (4) families, the structure having only four (4) dwelling units.

DWELLING, SINGLE-FAMILY: A building arranged or designed to be occupied by one family, the structure having only one dwelling unit.

DWELLING, THREE-FAMILY: A building arranged or designed to be occupied by three (3) families, the structure having only three (3) dwelling units.

DWELLING, TOWNHOME, (also referred to in this code as "Townhome"): A one family dwelling unit, located on its own Lot, in a row of at least two such units in which each unit shares one or more common fire-resistant walls with one or more Dwelling Units, each unit has its own front access to the outside, and each unit is separated from any other unit by one or more vertical common fire-resistant wall. Townhome Dwellings are individually owned and do not share common floor/ceilings with other Dwelling Units.

DWELLING, TWO-FAMILY: A building arranged or designed to be occupied by two (2) families, the structure having only two (2) dwelling units.

EASEMENT: A negotiated interest in the land of another which allows the easement holder specified uses or rights without actual ownership of the land.

ELDERLY CARE: A long term care residential facility for the elderly. The term does not include a healthcare facility.

ELDERLY PERSON: A person who is sixty (60) years old or older, and who desires or needs to live with other elderly persons in a group setting, who may or may not be capable of living independently.

ENGINEER: The person or firm appointed by the City Council to be the Delta City Engineer.

EQUIPMENT SHELTER: A structure used to house equipment for telecommunications facilities.

ESCROW: A deposit of cash with the City or an approved, alternate security in lieu of cash held to ensure a guarantee.

FARM ANIMALS/LIVESTOCK: Animals other than household pets that may, where permitted, be kept and maintained on private property.

FARM ANIMALS/LIVESTOCK (NON-COMMERCIAL USES): See Farm animals/livestock. Commercial use of animals/livestock or goods produced including but not limited to meat, eggs, manure, etc. are prohibited.

FEE SCHEDULE: See definition of Delta City consolidated fee schedule.

FENCE: A physical barrier to delineate, contain or designate an area designed for a specific use, such as an enclosure for a dwelling unit, an area of storage, etc.

FENCE, ELECTRIC: A fence wired with low voltage (12 volt maximum) electricity.



FENCE, RAZOR: A fence with razor coil, cable or tooth wire along certain portions.

FENCE, WILDLIFE/LARGE ANIMAL: Any inherently sturdy steel or solid wood fencing, which may be coupled with wire or other materials for the purpose of containing or deterring large animals or wildlife from passage. Open fencing allowed at a height of six feet (6') or more when a need is shown to protect animals from entering or leaving an area.

FINAL ACTION: The latter of the final vote or the approved, written decision on a matter.

FINAL PLAT: A recordable subdivision.

FIREWORKS SALES/STANDS: The temporary display and sale of legally allowed fireworks. This use requires a business license and a temporary permit issued from the Delta City Fire Chief or his/her designee after the business has had a satisfactory fire inspection.

FLOOR AREA, GROSS: The area of a building, including all enclosed areas designed for human occupation. Gross floor area does not include unenclosed porches, balconies, patios and decks, vent shafts, courtyards or garages, up to a maximum floor area of six hundred (600) square feet.

FLOOR AREA, NET LEASABLE: Gross floor area excluding common hallways, mechanical and storage areas, and restrooms.

FLOOR AREA RATIO (FAR): The maximum allowed gross floor area divided by the area of the lot or parcel.

FRONT: The front side of a lot or parcel shall be that side which abuts a street or land on which vehicular ingress or egress to the lot occurs.

FRONTAGE: The length of the property line of the lot fronting on one side of a street.

GARAGE, COMMERCIAL: A building other than a private garage used for the temporary parking of automobiles with or without a fee.

GARAGE, PRIVATE (Including UNENCROACHING CARPORT): A detached accessory building or portion of a main building for the parking or temporary storage of automobiles of the occupants of the premises.

GATED COMMUNITY: A subdivision or residential area where primary access is regulated through a gated entry point.

GENERAL MERCHANDISE SALES AND RELATED SERVICES: Stores, department stores or shops intended for sale of goods or merchandise, but not including convenience goods, liquor, motor vehicles, campers, trailers or lumber.

**GENERAL PLAN:** A document that a Municipality adopts that sets forth general guidelines for proposed future development of the land within the Municipality, as set forth in Utah Code §§ 10-9a-401 and 10-9a-302.

**GOVERNING BODY:** The Delta City Council.

**GRADE:**

- A. For buildings adjoining more than one street, the average of the elevations of the sidewalks at the centers of all walls adjoining streets.
- B. For buildings adjoining one street only, the elevation of the sidewalk at the center of that wall adjoining the street.
- C. For buildings having no wall adjoining the streets, the average level of the ground (finished surface) adjacent to the exterior walls of the buildings.
- D. All walls approximately parallel to and not more than five feet (5') from a street line are to be considered as adjoining a street.

**GROUP HOME:** A profit or nonprofit boarding home for the sheltered care of persons with special needs, which, in addition to providing food and shelter, may also provide some combination of personal care, social or counseling services, and transportation. Group home includes congregate facilities for all persons.

**GROUP HOME, ASSISTED LIVING FACILITY:** A residential facility, licensed by the state of Utah, with a home-like setting that provides an array of coordinated support personnel and healthcare services, available twenty-four (24) hours per day, to residents who have been assessed under the Utah Department of Health or whom the Utah Department of Human Services requires or recommends any of these services. Each resident shall have a service plan based on the assessment, which may include: a) Specified services of intermediate nursing care; b) Administration of medication; and c) Support services promoting resident's independence and self-sufficiency. Such a facility does not include adult day care provided in conjunction with a residential facility for elderly persons or a residential facility for persons with a disability.

**GROUP HOME, DISABLED:** A residence in which more than one person with a disability resides and is licensed or certified by the Utah Department of Human Services or the Department of Health. This term includes a recovery residence and a residential treatment facility as defined in Utah Code § 62A-2-101.

**HANDICAPPED PERSON:** A person who has a severe, chronic disability that is attributable to mental or physical impairments, that is likely to continue indefinitely, and that results in a substantial functional limitation in three (3) or more of the following areas of major life activity: capacity for independent living; economic self-sufficiency; learning; mobility; receptive and expressive language; self-care; self-direction; and requires special interdisciplinary or generic care, treatment or other services that are individually planned and coordinated to allow the person to function in, and contribute to, a residential neighborhood.

**HEALTH DEPARTMENT:** The Utah State Division of Environmental Health or local health agency having jurisdiction.

**HEALTHCARE CENTER (CONVALESCENT CENTER):** A publicly or privately operated facility, other than a hospital, intended for the long term, inpatient care of human illness or infirmity, including the elderly and developmentally disabled, normally employing the services of skilled and licensed practitioners.

**HEAVY/FARM EQUIPMENT SALES:** Vehicles or equipment in excess of one ton used in farming, construction or other related services.

**HEIGHT, BUILDING:** The vertical distance from the existing grade to the highest point of the cornice of a flat roof or to the deck line of a mansard roof or to the midpoint of the highest gable of a pitch or hip roof.

**HOME OCCUPATION:** Any use conducted entirely within a single-family dwelling and carried on by persons residing within the dwelling unit, which use is clearly incidental and secondary to the use of the dwelling purposes and does not change the character thereof and in connection with which there is no display, nor stock in trade. The home occupation shall not include the sale of commodities except those which are produced on the premises and shall not involve the use of any accessory building or yard space or activity outside the main building, not normally associated with residential use. There shall be no advertising of any kind in connection with the home occupation; there shall be no employees outside of the family residing in the dwelling unit. There shall be no perceivable increase in local traffic. A home occupation may include emergency consultation, but shall not be for the general practice or profession.

**HOSPITAL:** An institution designed for the diagnosis, treatment and care of human illness or infirmity and providing health services, primarily for inpatients, and including as related facilities, laboratories, outpatient departments, training facilities and staff offices, but not including clinics or healthcare centers.

**HOTEL:** A building designed or occupied as the more or less temporary abiding place of fifteen (15) or more individuals who are, for compensation, lodged, with or without meals.

**HOUSEHOLD PETS:** Animals or birds ordinarily permitted in the house and kept for company or pleasure, such as dogs, cats and canaries, but not including a sufficient number of dogs to constitute a kennel, as defined in this section.

**IMPROVEMENTS:** Includes all roads, streets, curbs, gutters, gradings, landscaping, water and sewer systems, drainage systems, public facilities and sewer materials required by this title.

**INACTION:** An application is inactive and subject to denial on the basis of inactivity if, through the act or omission solely of the applicant and not of the City:

- A. More than six (6) months has passed since a request for additional information was made by the City without a response from the applicant;

- B. Upon notice the applicant is more than sixty (60) days in default of the payment of any fee assessed by resolution, or has not paid the fee under protest;
- C. The applicant has stated an intent to abandon the project; and
- D. The application appears to have been filed in bad faith for the purpose of attempting to vest rights prior to a zoning change, without actual intent to construct the project applied for.

**INDUSTRIAL (OR RESEARCH) PARK:** A tract of land that is subdivided and developed according to a plan for the use of a community of industries and related uses and that is of sufficient size and physical improvement to protect surrounding areas and the general community and to assure a harmonious integration into the neighborhood.

**INDUSTRY, LIGHT:** The manufacturing, compounding, processing, assembling, packaging or testing of goods or equipment entirely within an enclosed structure, with no outside storage, serviced by small (3/4 ton) trucks or vans, and imposing a nearly negligible impact upon the surrounding environment by noise, vibration, smoke, dust or pollutants.

**INDUSTRY, MEDIUM:** The manufacturing, compounding, processing, assembling, packaging or testing of goods or equipment within an enclosed structure, or an open yard that is capable of being screened from neighboring properties, is serviced by trucks or other vehicles, and whose environmental impact is within the industrial performance standards as outlined in this title.

**INTERMITTENT USE:** A temporary business of selling and delivering goods, wares and merchandise within the City of Delta.

**ITINERANT MERCHANT:** Any person, firm or corporation, whether as owner, agent, consignee or employee, whether or not a resident of the Municipality, who engages in a temporary business of selling and delivering goods, wares and merchandise within the Municipality, and who, in furtherance of such purpose, hires, leases, uses or occupies any building, structure, motor vehicle, tent, railroad boxcar, public room in any hotel, motel, lodging house, apartment, shop or any street, alley or other place within the Municipality, for the exhibition and sale of such goods, wares and merchandise, either privately or at public auction. This also includes a person, firm or corporation associating temporarily with a local dealer, trader, merchant or auctioneer, or by conducting such transient business in connection with, as part of, or in the name of any local dealer, trader, merchant or auctioneer.

**JUNKYARD:** The use of any lot, portion of a lot, or tract of land for the storage, keeping or abandonment of junk, including scrap metals or other scrap materials, or for the dismantling, demolition or abandonment of automobiles, other vehicles, or machinery or parts thereof; provided, that this definition shall not be deemed to include such uses which are clearly accessory and incidental in the district.

**KENNEL, COMMERCIAL:** A shelter for or a place for three (3) or more dogs or cats are bred, boarded or trained for monetary gain.

**KENNEL, PRIVATE:** A shelter for or a place for three (3) or more dogs or cats are bred, boarded or trained for no monetary gain.

**LAND USE APPLICATION:** An application required by a Municipality's land use ordinance.

**LAND USE AUTHORITY:** A person, board, commission, agency or other body designated by the local legislative body to act upon a land use application.

**LAND USE ORDINANCE:** A planning, zoning, development or subdivision ordinance of the Municipality, but does not include the general plan.

**LATTICE TOWER:** A self-supporting multiple sided, open steel frame structure used to support telecommunications antenna equipment.

**LAUNDROMAT:** An establishment in which patrons wash, dry or dry clean clothing and other fabrics in coin operated, self-service machines.

**LAUNDRY:** An establishment at which clothing and other fabrics are washed and pressed. Excluded from this definition are dry cleaning establishments and laundromats.

**LEASABLE, GROSS:** Total area including hallways, mechanical equipment room and common bathrooms.

**LEASABLE, NET:** Total area excluding hallways, mechanical equipment room and common bathrooms.

**LEGISLATIVE BODY:** The Delta City Council.

**LIQUOR STORE:** A retail sales store authorized by the Utah Department of Alcoholic Beverage Control to sell packaged alcoholic beverages for off premises consumption.

**LOCAL JURISDICTION:** Delta City.

**LOT:** A parcel of land occupied or to be occupied by a main building or group of buildings (main and accessory), together with such yards, open spaces, lot width and lot area as are required by this title and having frontage upon a street.

**LOT, CORNER:** A lot situated at the intersection of two (2) streets, the interior angle of such intersection does not exceed one hundred thirty five degrees (135°). A corner lot fronts two (2) streets.

**LOT DEPTH:** The horizontal distance between the front and rear lot lines measured in the main direction of the side lot line.

**LOT LINE:** Property lines bounding the lot.

**LOT LINE ADJUSTMENT:** The relocation of the property boundary line between two (2) adjoining lots with the consent of the owners of record, so long as no new lot is created, and the adjustment does not violate this title.

**LOT LINE, FRONT:** The property line dividing a lot or parcel from the right-of-way of the street from which structure takes access.

**LOT LINE, REAR:** The property line opposite the front lot line.

**LOT LINE, SIDE:** Any lot or property line other than a front or rear lot line.

**LOT WIDTH:** The minimum distance between the side lot lines at the front yard or front building facade. For three (3) sided lots, the minimum distance between the rear and side lot lines at the front yard or front building facade.

**LOW POWER RADIO SERVICES FACILITY:** An unmanned structure, which consists of equipment used primarily for the transmission, reception or transfer of voice or data through radio wave or wireless transmissions. Such sites typically require the construction of transmission support structures to which antenna equipment is attached.

**LUMBER SALES AND STORAGE:** The sale and display of lumber and building supplies, including the outside storage of lumber and related merchandise.

**MAJOR STREET PLAN:** The major street plan of Delta City.

**MANUFACTURED HOME:** A structure, transportable in one or more sections, which in the traveling mode, is eight (8) body feet or more in width or forty (40) body feet or more in length, or, when erected on site, is three hundred twenty (320) or more square feet, and which is built on a permanent chassis and designed to be used as a dwelling with or without a permanent foundation when connected to the required utilities, and includes the plumbing, heating, air conditioning and electrical systems contained therein. Calculations used to determine the number of square feet in a structure will be based on the structure's exterior dimensions measured at the largest horizontal projections when erected on site. These dimensions will include all expandable rooms, cabinets and other projections containing interior space, but do not include bay windows. This term includes all structures which meet the above requirements except the size requirements and with respect to which the manufacturer voluntarily files a certification pursuant to 24 CFR 3282.13, and complies with the standards set forth in 24 CFR part 3280.

**MANUFACTURING USE:** Research and development facilities, testing laboratories and facilities for the production, fabrication, processing or assembly of goods and products.

**MASSAGE THERAPY SERVICES:** See definition of office, professional.

**MASTER PLAN:** The master plan of Delta City.

.

**MEDICAL CLINIC:** See definition of office, professional.

**MENTAL HEALTH CENTER:** A publicly or privately operated facility, intended for the diagnosis and treatment of mental or emotional disorders.

**MILITARY SURPLUS GOODS/STORE:** New or used military equipment, vehicles or supplies, which are available for resale to the general public.

**MIXED USE, COMMERCIAL:** Development which incorporates a mix of uses, including retail commercial and/or offices and residential.

**MIXED USE, HORIZONTAL:** Commercial and residential uses which are within close proximity to each other and designed in a "village" manner, but not necessarily within the same building structures.

**MIXED USE, VERTICAL:** Commercial and residential uses, which are within the same building structure.

**MOBILE HOME:** A detached single-family dwelling unit of not less than thirty feet (30') in length, designed for long term occupancy and to be transported on its own wheels or on a flatbed or other trailers or detachable wheels; containing a flush toilet, sleeping accommodations, a tub or shower bath, kitchen facilities, and plumbing and electrical connections provided for attachment to appropriate external systems, and ready for occupancy except for connections to utilities and other work. Presectionalized modular, or prefabricated houses not placed on permanent foundations, shall be regarded as mobile homes and only authorized in mobile home parks.

**MOBILE HOME LOT:** A designated portion of a mobile home park, designed for the accommodation of one mobile home and its accessory buildings or structures which complies with all relevant Building Codes and ordinances.

**MOBILE HOME PAD:** Part of the mobile home space which has been prepared and reserved for the placement of one mobile home.

**MOBILE HOME PARK:** A residential development in which owners of mobile homes or manufactured housing may rent or lease a lot on which to place their home. Such developments may provide all of the amenities and improvements typical of subdivisions.

**MOBILE HOME PARK PLUMBING SYSTEM:** The park sewer and water supply systems within the park property line.

**MOBILE HOME PARK SEWAGE SYSTEM:** Any pipe or line not built into the mobile home which is used for the disposal of human waste.

**MOBILE HOME SERVICE BUILDING:** A building which is not a mobile home which houses separate toilet and bathing facilities for men and women and which may also have laundry facilities, flushing rim sink, and other facilities as may be required by the ordinances of the City of Delta.

**MODEL HOME:** A dwelling unit used initially for display or marketing purposes, with a certificate of occupancy, which typifies the units that will be constructed.

**MODULAR HOME:** A permanent dwelling structure built of prefabricated units which are assembled and erected on the site, and which meets the International Building Code.

**MONOPOLE:** A single cylindrical steel or wood pole that acts as the support structure for antennas.

**MONUMENT SIGN:** A sign six feet (6') or less in height which is flush to the ground.

**MORTUARY, FUNERAL HOME:** An establishment in which the human dead are prepared for burial or cremation. The facility may include a chapel for the conduct of funeral services, spaces for informal gatherings and related accessory uses.

**MOTEL:** A building or group of buildings containing individual sleeping units designed and used primarily for the accommodation of transient automobile travelers and with automobile parking immediately accessible.

**MUNICIPAL FACILITIES:** Those improved properties owned by the Municipality or the public.

**NATURAL WATERWAYS:** Those areas, varying in width, along streams, creeks, springs, gullies or washes that are natural drainage channels as determined by the building inspector.

**NARROW RIGHT-OF-WAY:** A right-of-way that is forty feet(40') or less.

**NEW DEVELOPMENT:** Any new construction activity.

**NONCOMPLYING STRUCTURE:** A structure that legally existed before its current zoning designation and because of a zoning change, does not conform to the zoning district's development standards.

**NONCONFORMING SIGN OR SIGN STRUCTURE:** A sign or sign structure or portion thereof lawfully existing prior to August 16, 2012, which does not conform to all height, area, yard spacing, animation, lighting or other regulations prescribed in the zone in which it is located.

**NONCONFORMING USE:** A use of a lot or parcel that legally existed on the lot or parcel before its current zoning designation; has been maintained continuously for the preceding twelve (12) months; and does not conform with the zoning regulations that now govern the land.



**NURSERY:** A business that grows, cultivates and/or distributes and sells plants and other landscaping or horticulture related items.

**NURSERY (PERSONAL USE):** A use wholly, or partially, contained within one or more greenhouses where trees, shrubs, flowers, or vegetable plants are grown for personal use. For-profit sales of goods are prohibited.

**NURSING HOME:** A business described also as a "rest home" or "convalescent home", other than a hospital, in which persons are lodged long term and furnished with care rather than diagnoses or treatment.

**OFFICE, BUSINESS OR GOVERNMENT:** A place intended for the conduct of administration or services by a business enterprise or unit of government.

**OFFICE, PROFESSIONAL:** A place intended for the conduct of a recognized learned profession. Such uses include offices or clinics devoted to treatment and care of human illness or injury (medical, dental, chiropractic offices, massage therapist and similar uses). Other professions so defined would include, but not be limited to, accountants, architects, engineers and lawyers. Definition does not allow for inpatient care facilities or adult oriented businesses.

**OFFICIAL STREETS MASTER PLAN:** As adopted by the City Council, the designation of each existing and planned street and right-of-way, and those located on approved and filed plats, for the purpose of providing for the development of the streets, highways, roads and rights-of-way and for their future improvement, reconstruction, realignment and necessary widening, including provision for curbs and sidewalks. The classification of each street and right-of-way is based upon its location in the respective zoning district of the City, its present and estimated future traffic volume and its relative importance and function.

**OFFICIAL ZONING MAP:** The map adopted by the City Council pursuant to law showing the streets, zoning districts and City boundaries; and any amendments or additions thereto resulting from the approval of rezones, subdivision or annexation plats and the subsequent filing of such approved plats.

**OPEN SPACE:** Space reserved in parks, courts, playgrounds, golf courses and other similar open areas and those areas reserved to meet the density requirements of planned unit development. **ORDINARY HIGH WATER MARK:** The line on the bank to which the high water ordinarily rises annually in season as indicated by changes in the characteristics of soil, vegetation or other appropriate means, which consider the characteristics of the surrounding areas. Where the ordinary high water mark cannot be found, the top of the channel bank shall be substituted. In braided channels, the ordinary high water mark or substitute shall be measured so as to include the entire stream feature.

**OUTDOOR RECREATION, PARK OR PLAYGROUND (PUBLIC OR PRIVATE):** An area free of buildings, except for restrooms, dressing rooms, equipment storage and maintenance buildings, and open air pavilions and used primarily for recreation activities not involving motor vehicles or overnight use.

**OUTDOOR RECREATIONAL USES:** Recreational activities involving off highway vehicles and similar motorized vehicles for recreational use and horse arenas, equestrian parks and equine activity, including, but not limited to, equine shows, fairs, competitions, performances, racing or sales that involve any breed of equines and any equine disciplines; boarding or training equines and teaching persons equestrian skills. The Planning Commission may also determine other equine activities that are consistent with this section.

**OWNER:** Any person, or group of persons, having record title to the property sought to be developed or subdivided and the owner's agent.

**PARCEL:** An unplatted unit of land described by metes and bounds and designated by the County Recorder's Office with a unique tax identification number.

**PARCEL OF LAND:** An area of land all portions or divisions of which are contiguous and in the possession or ownership of one person.

**PARKING AREA:** An unenclosed area or lot, other than a street, used or designed for parking, nine feet by eighteen feet (9' x 18').

**PARKING AREA, PRIVATE:** An open area, other than a street, used for the parking of the automobiles of occupants of a dwelling, or hotel..

**PARKING, PUBLIC:** A parking area or parking facility to be used by the public for fee or otherwise.

**PARKING, RESIDENTIAL:** A parking area or structure used exclusively for residential, noncommercial uses.

**PARKING, SHARED:** The development and use of parking areas on two (2) or more separate properties for joint use by the businesses or residents on those properties.

**PARKING SPACE, AUTOMOBILE:** A space within a building or a private or public parking area, exclusive of driveways, ramps, columns and office and work areas, for the parking of one automobile.

**PARTIAL STREET:** The portion of a street within a subdivision comprising the minimum required right-of-way on which improvements are constructed to width of one-half (1/2), plus ten feet (10') over the centerline of the typical street cross section, as set out in the Construction Standards.

**PAWNSHOPS:** A business dealing in or collecting used or secondhand merchandise of personal property, which has been legitimately obtained.

**PERMANENT:** Lasting or intended to last or remain unchanged indefinitely.

**PERSON:** An individual, individuals, corporation, partnership or incorporated association of individuals, such as a club. Also includes tenants in common, joint tenants, firms, limited partnerships or associations of individuals however styled or designated. Any use of the word person, as defined in this section, shall be deemed to include the singular or plural and each gender, as appropriate.

**PERSONAL SERVICES:** Establishments primarily involved in providing personal grooming and related services. This definition shall include barbershops, beauty parlors, tailors, massage services, but not laundries or dry cleaners.

**PET GROOMING:** The grooming of small pets, such as dogs and cats; provided, that no more than five (5) animals may be on the premises at one time and that no lodging of animals is allowed.

**PLANNING COMMISSION:** The Delta City Planning Commission.

**PLAT:** A map or other graphical representation of lands being laid out and prepared in accordance with Utah Code § 10-9a-603. See DCC 18.64, "General Development Standards".

**PRIMARY DWELLING:** Means a single-family that:

- A. is detached; and
- B. is occupied as the primary residence of the owner of record.

**PRELIMINARY PLAT:** The preliminary drawings of a proposed subdivision, specifying the layout, uses and restrictions.

**PRESCHOOL:** The education or teaching of children, including kindergarten preparation, music lessons, etc.

**PROPERTY:** Any parcel, lot or tract of land, including improvements thereon, in the possession of or owned by, or recorded as the real property of, the same person or persons.

**PROPERTY LINE:** The boundary line of a parcel or lot.

**PROPERTY LINE, FRONT:** That part of a parcel or lot, which abuts a street.

**PROTECTION STRIP:** A strip of land of less than the minimum depth required by this title for a building lot bordering the boundary of a subdivision or a street within the subdivision for the purpose of controlling the access of property owners abutting the subdivision to the street.

**PUBLIC HEARING:** A hearing at which members of the public are provided a reasonable opportunity to comment on the subject of the hearing.

**PUBLIC IMPROVEMENT:** Any building, water system, drainage ditch, roadway, parkway, sidewalk or other pedestrian way, tree, lawn, off street parking lot, space or structure, lot improvement, or other facility for which the City may ultimately assume responsibility, or which may affect a City improvement.

**PUBLIC MEETING:** A meeting that is required to be open to the public under Utah Code 52-4, Open and Public Meetings.

**PUBLIC RIGHT-OF-WAY:** An area of land that is legally described in a registered deed for the provision of public access. Features within public right-of-ways (public ways) include streets, sidewalks, bridges, curbs, gutters, culverts, drains, waterways and others that are legally dedicated and recorded for the use of the general public.

**PUBLIC SERVICE:** Uses, which may be housed in separate buildings, or which may occupy a space within a building, that are operated by a unit of government to serve public needs, such as police (with jail), fire service, ambulance, Post Office or judicial court, but not including public utility stations or maintenance facilities.

**PUBLIC STREET:** A street, including the entire right-of-way, which has been dedicated to and accepted by the City of Delta or other governmental agency or which has been devoted to public use by legal mapping, use or other means.

**PUBLIC UTILITIES, EXCEPT SEWER:** See public utility stations; excluding sewage installments and utilities.

**PUBLIC UTILITY STATIONS:** A structure or facility used by a public or quasi-public agency to store, distribute, generate or chemically treat water, power, gas, sewage, equipment or other service elements.

**REASONABLE NOTICE:** The requirements of reasonable notice are met if notice of hearing or meeting is posted in at least three (3) public places within the jurisdiction and/or notice of the hearing or meeting is published in a newspaper of general circulation in the jurisdiction, or if actual legal notice of the hearing or meeting is given.

**RECORD OF SURVEY MAP:** A graphic illustration of a survey of land prepared in accordance with State laws.

**RECREATIONAL VEHICLE:** A vehicular unit, other than a mobile home, primarily designed as a temporary dwelling for travel, recreational and vacation use, which is either self-propelled or is mounted on or pulled by another vehicle, including, but not limited to, a travel trailer, a camping trailer, a truck camper, a motor home, a fifth wheel trailer and a van.

**RECREATIONAL VEHICLE PARK (TRAVEL TRAILER PARK):** Any area or tract of land or separately designated section where lots are rented to one or more owners or users of recreational vehicles for a temporary time.

**RELIGIOUS, EDUCATIONAL INSTITUTE:** A 28 USC 501(c)(3) nonprofit organization engaged in teaching, community programs or spiritual endeavors, which qualifies as a tax exempt religious institution under title 28 of the U.S. Code.

**REPAIR SERVICES, SMALL APPLIANCE OR EQUIPMENT:** An establishment for the repair of household or other small appliances or equipment and at which no such appliances or their parts are stored out of doors.

**RESIDENTIAL FACILITY FOR THE DISABLED/RESIDENTIAL FACILITY FOR PERSONS WITH A DISABILITY:** A facility that is occupied by three (3) to five (5) unrelated persons with disabilities on a twenty four (24) hour per day basis in a family type arrangement under the supervision of a house family or manager, and that conforms to all applicable standards and requirements of and is licensed by the Utah Department of Human Services - Division of Services for People with Disabilities or Health, and is operated by or under contract with that department. Such facilities shall not include facilities for the following: secure treatment, inpatient treatment, residential treatment, adult daycare, day treatment, comprehensive mental health treatment, comprehensive substance abuse treatment, or domestic violence treatment as defined in Utah Code § 62A-2-101.

**RESIDENTIAL FACILITY FOR THE ELDERLY:** A long term care residential facility for elderly persons. The term does not include a healthcare facility.

**RESIDENTIAL SUPPORT:** Arranging for or providing the necessities of life as a protective service to individuals or families who are disabled or who are experiencing a dislocation or emergency which prevents them from providing these services for themselves or their families. Treatment is not a necessary component of residential support.

**RESIDENTIAL TREATMENT CENTER:** A twenty four (24) hour group living environment for three (3) to nine (9) individuals unrelated to the owner or provider that offers room or board and specialized treatment, rehabilitation or rehabilitation services for persons with emotional, psychological, developmental or behavioral dysfunctions or impairments. For the purposes of this section, residential treatment center shall not include facilities for comprehensive substance abuse treatment or domestic violence treatment as defined in Utah Code § 62A-2-101.

**RESOURCE FAMILY HOME:** A home licensed to provide services to a child in the custody of the State and includes a foster care home and a legal risk home.

**RESTAURANT, CAFE, CONFECTIONERY:** An establishment where food is prepared and served to customers for consumption on the premises.

**RESTAURANT, FAST FOOD, DRIVE-IN:** An establishment distinguished from a traditional sit down restaurant in that service is provided from a counter or window for consumption either off or on the premises; on premises consumption normally requires considerably less time than consumption in a traditional restaurant. Service may also be provided to customers in automobiles by use of an outside drive-up window; parking is provided immediately adjacent to the building. This definition includes also specialty food stores, such as ice cream parlors or delicatessens, having counter or window service.

**RESUBDIVISION:** A change in a map of an approved or recorded subdivision plat if such change affects any right-of-way or lot line; or any change in a map or plan legally recorded prior to the adoption of regulations controlling subdivisions.

**RIGHT-OF-WAY:** A strip of land, dedicated to public use, that is occupied or reserved to be occupied by a street, crosswalk, trail, stairway, railroad, road, utilities or for another special use.

**ROAD CLASSIFICATION:** The streets, highways, roads and rights-of-way designated on the Streets Master Plan.

**ROAD, RIGHT-OF-WAY WIDTH:** The distance between property lines measured at right angles to the centerline of the street.

**ROOF:** The building element, which covers the top of the structure as the walls enclose the sides.

**SANITARY SEWER AUTHORITY:** The department, agency or public entity with responsibility to review and approve the feasibility of sanitary sewer services or on site wastewater systems.

**SATELLITE RECEIVING STATION:** Any apparatus or device designed for the purpose of transmitting and/or receiving radio, television, satellite microwave, or other electromagnetic energy signals between terrestrially and/or orbital based uses. This definition includes, but is not limited to, what are commonly referred to as satellite earth stations, satellite microwave antennas, TVROs or dish antennas. This definition does not include conventional television antennae.

**SCHOOL, PRIVATE OR QUASI-PUBLIC:** A school operated by a private or quasi-public organization or individual, which has a program similar to that provided in any public school in the State of Utah, except that such curriculum may include religious instruction. A private school may be a profit making or nonprofit organization. This definition shall not include commercial schools.

**SCHOOL, PRIVATE, QUASI-PUBLIC (40' FROM ALL PROPERTY LINES, NO RESIDENCE WITHIN):** See schools, private, quasi-public. The building must be forty feet (40') from all property lines, no residence within.

**SCHOOL, PUBLIC:** An educational facility operated by a school district or other public agency of the State of Utah.

**SCHOOL, PUBLIC (40' FROM ALL PROPERTY LINES, NO RESIDENCE WITHIN):** See school, public. The building must be forty feet (40') from all property lines, no residence within.

**SCREEN OR SCREENED:** The act, process or result of visually and/or audibly shielding or obscuring a structure or use from adjacent property by fencing, walls, berms, densely planted vegetation or other features.

**SECURE TREATMENT:** Twenty four (24) hour specialized residential treatment or care for persons whose current functioning is such that they cannot live independently or in a less restrictive environment. Secure treatment differs from residential treatment to the extent that it requires intensive supervision, locked doors and other security measures which are imposed on residents with neither their consent nor control.

**SENIOR CITIZEN CENTER:** A government sponsored public building, other than a church or school, serving the social and recreational needs of the elderly. Such a center may include a meeting hall and cooking and dining facilities for large groups, but shall not provide overnight lodging.

**SETBACK:** The required minimum distance between a building or structure and the closest of the following: property line; platted street; or existing curb or edge of a street.

**SHOPPING CENTER, COMMUNITY (RETAIL BUSINESS):** A completely planned and designed commercial development providing for the sale of general merchandise and convenience goods and including a variety store, discount store or supermarket.

**SHOPPING CENTER, NEIGHBORHOOD:** A planned commercial development providing primarily for the sale of convenience goods and services. The center is designed to serve a residential neighborhood.

**SIGHT DISTANCE TRIANGLE:** A triangular area at the intersection of two (2) streets bounded by property lines connecting them at points thirty five feet (35') from the intersection of the two (2) adjoining property lines, which is to be kept reasonably clear to allow for the unimpeded view of drivers or pedestrians approaching the intersection.

## TYPICAL SITE TRIANGLE AREA GUIDE

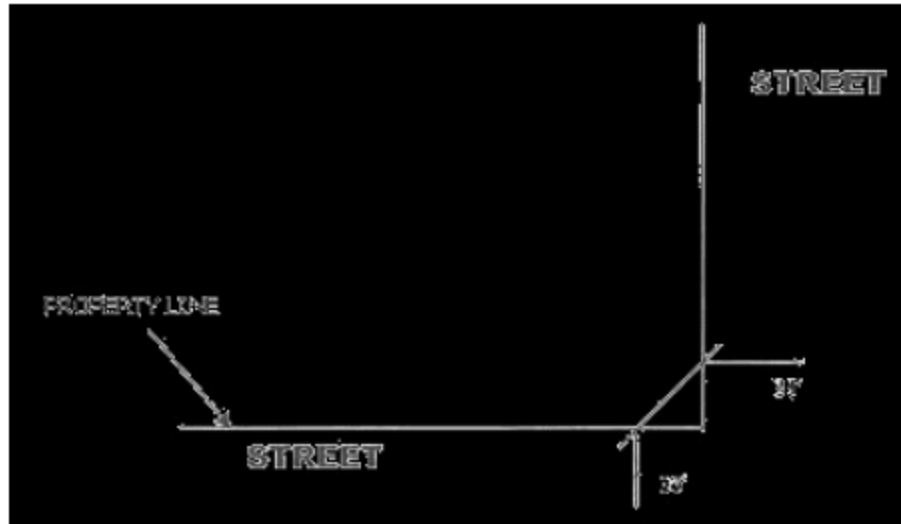

**SIGNIFICANT VEGETATION:** Includes all large trees six inches (6") in diameter or greater measured four and one-half feet (4 1/2') above the ground, all groves of small trees, and all clumps of oak or maple covering an area fifty (50) square feet or more measured at the drip line.

**SIGNS:** A presentation of words, letters, figures, designs, pictures or colors publicly displayed so as to give notice relative to a person, a business, an article or merchandise, a service, an assemblage, a solicitation or a request for aid; also the structure or framework or any natural object on which any sign is erected or is intended to be erected or exhibited or which is being used or is intended to be used for sign purposes.

- A. **Abandoned Sign:** Any sign which is obsolete or which has not been properly maintained for a period of three months, at which time such a sign can be removed by the City and a removal fee charged to the owner.
- B. **Billboard:** A freestanding ground sign located on industrial, commercial or residential property if the sign is designed or intended to direct attention to a business, product or service that is not sold, offered or existing on the property where the sign is located. For purposes of this definition, a billboard shall be considered to be an off premises sign.
- C. **Convert:** To change a billboard sign face from its existing, non-digital surface to a digitally controlled surface.
- D. **Directional Signs:** Signs containing information about public places owned or operated by Federal, State or local governments or their agencies, publicly or privately owned, natural phenomena, historic, cultural, scientific, educational or religious sites and areas of natural scenic beauty or naturally suited for outdoor recreation.
- E. **Erect:**
  1. To construct, build, raise, assemble, place, affix, attach, create, paint, draw or in any other way bring into being;
  2. Erect does not include any activities defined in paragraph A if they are



performed incident to the change of an advertising message or customary maintenance of a sign.

- F. **Maintain Or Maintenance:** To repair, refurbish, repaint or otherwise keep an existing sign structure safe and in a state suitable for use, including signs destroyed by vandalism or by acts of God. Owner or lessee of a sign may repaint, redecorate and/or change letters or panels on his/her own sign.
- G. **Off Premises Signs:** A sign that advertises, communicates or identifies products, services, businesses, organizations, activities or messages that are not located, conducted, manufactured or sold on the premises where the sign is displayed. Off-premises signs generally include billboards and other similar signs.
- H. **Official Signs And Notices:** Signs and notices erected and maintained by Delta City within its territorial or zoning jurisdiction for the purpose of carrying out official duties or responsibilities in accordance with direction and authorization contained in Federal, State or local law.
- I. **On Premises Signs:** Signs which advertise or direct attention to a commercial building or a use conducted, a commodity sold or a service performed on the premises where the sign is located.
- J. **Sign Setback:** The minimum distance that any portion of a sign or sign structure shall be from any street property line.

**SITE DEVELOPMENT STANDARDS:** Regulations unique to each zone concerning standards for development, including, but not limited to, lot areas, setbacks and building height.

**SKATING - ROLLERBOARD PARK:** Any facility, structure or area in which skateboarding, in-line skating, or bicycle riding is allowed, which is owned, operated and maintained by the City, and which has been designated as a "skating-rollerboard park" by ordinance of the City Council.

**SLOPE:** The level of inclination of land from the horizontal plane determined by dividing the horizontal run, or distance, of the land into the vertical rise, or distance, of the same land and converting the resulting figure to a percentage value.

**SMALL ENGINE REPAIR:** An establishment engaged in the repair and maintenance of small engines with an engine displacement size no greater than two thousand (2,000) cc. This includes, but is not limited to: motorcycles, OHVs, ATVs, home and garden tools and equipment, outboard motor watercraft (engine removed), snowmobiles, chainsaws and other similar small engines.

**SOLAR ENERGY SYSTEM:** A system of apparatus and equipment capable of collecting and converting solar radiation into heat, mechanical or electrical energy, and transferring those forms of energy by a separate apparatus to storage or to point of use, including, but not limited to, water heating, space heating or cooling, electric energy generation or mechanical energy generation.

**SOLICITING OR SOLICIT OR SOLICITATION:** Any of the following activities:

- A. Seeking to obtain sales or orders for the exchange of goods, wares, merchandise or perishables of any kind, for any kind of remuneration or consideration, regardless of whether advance payment is sought.
- B. Seeking to obtain prospective customers to apply for or to purchase insurance, subscriptions to publications, or publications.
- C. Seeking to obtain contributions of money or any other thing of value for the benefit of any person or entity.
- D. Seeking to obtain orders or prospective customers for goods or services.
- E. Seeking to engage an individual in conversation at a residence for the purpose of promoting or facilitating the receipt of information regarding charitable conduct, or a home solicitation sale.
- F. Other activities falling within the commonly accepted definition of "soliciting", such as hawking or peddling.
- G. This section shall not be construed to disallow the proselytizing of religious or charitable groups.

**SOLICITORS:** Persons engaged in door-to-door solicitation.

**SPECIAL DISTRICT:** An entity established under the authority of Utah Code 17A, Special Districts, and any other governmental or quasi-governmental entity that is not a county, municipality, school district or unit of the State.

**STABLE, PRIVATE:** A detached accessory structure used for the keeping and housing of livestock by the occupants of the premises.

**STABLES, PRIVATE (PROVIDED STRUCTURES HOUSING ANIMALS SHALL NOT BE CLOSER THAN 200' TO ANY PROPERTY LINE):** See definition of stable, private. No part of the structures may be closer than two-hundred feet (200') to any property line.

**STABLE, PUBLIC:** A stable other than a private stable.

**STABLES, PUBLIC (PROVIDED STRUCTURES HOUSING ANIMALS SHALL NOT BE CLOSER THAT 200' TO ANY PROPERTY LINE):** See definition of stable, public. No part of the structures may be closer than two-hundred feet (200') to any property line.

**STABLES, PUBLIC/ COMMERCIAL:** A building in which domestic animals, such as horses, ponies, and cattle, are sheltered and fed, having stalls or compartments. Animals may be boarded for profit.

**STEALTH TELECOMMUNICATIONS FACILITY:** A telecommunications facility, which is disguised as another object or otherwise concealed from public view.

**STORAGE LAND SEA CONTAINERS or CARGO STORAGE CONTAINER:** An all steel container (some with wooden floors) and strength to withstand shipment, storage and handling. Such containers include reusable steel boxes, freight containers, enclosed highway tractor trailers, and bulk shipping containers; originally a standardized reusable vessel that was designed for and used in the parking, shipping, movement, transportation or storage of freight, articles or goods or commodities; generally capable of being mounted or moved on a rail car, truck trailer or loaded on a ship.

**STORAGE UNIT, PUBLIC/ COMMERCIAL:** A building or series of buildings in which spaces are rented, leased, or sold for the purpose of storage. Spaces shall be individually secured and enclosed.

**STORY:** A habitable level within a building serving to define the building height. Basements that emerge less than four feet (4') from grade or attics not exceeding four feet (4') at the kick wall shall not constitute an additional story.

**STORY, HALF:** A story with at least two (2) of its opposite sides situated in a sloping roof, the floor area of which does not exceed two-thirds (2/3) of the floor immediately below it.

**STREAM:** A naturally fed watercourse, that flows year-round or intermittently during years of normal rainfall. This definition excludes ditches and canals constructed for irrigation and drainage purposes.

**STREAM CORRIDOR:** The corridor defined by the stream's ordinary high water mark.

**STREET:** A private or public right-of-way, including a highway, avenue, boulevard, parkway, road, lane, walk, alley, viaduct, subway, tunnel, bridge, public easement or other way. Also includes a thoroughfare which has been dedicated and accepted by the City Council, which Delta City has acquired by prescriptive right or which Delta City owns, or which has been offered for dedication on an approved final plat, or a thoroughfare of at least thirty three feet (33') in width which has been abandoned or made public by right of use and which affords access to abutting property, including highways, roads, lanes, avenues and boulevards.

**STREET, ACCESS:** A street that serves a small number of dwellings and usually does not allow through traffic. Usual ADT (average daily traffic) range is zero to two hundred fifty (250) vehicles.

**STREET, ARTERIAL:** A street which provides for through traffic movement between areas and across the City, with moderate access to abutting property subject to necessary control of entrances, exits and curb use, and also provides access to highways. Arterials are not usually included in residential street plans. Maximum ADT is three thousand plus (3,000+) vehicles.

**STREET, COLLECTOR:** A street that provides for a high volume of traffic movement between major arterials and local streets, and direct access to abutting property. Usual ADT range is one thousand (1,000) to three thousand (3,000) vehicles.

**STREET, LOCAL:** A street that provides for direct access to abutting land and for local traffic movements.

**STREET, PRIVATE:** A right-of-way or easement in private ownership, not dedicated or maintained as a public street, which affords the principal means of access to two (2) or more lots.

**STREET, PUBLIC:** A street that has been dedicated to and accepted by the City Council; that the City has acquired and accepted by prescriptive right; or that the City owns in fee. A public thoroughfare, which affords principal means of access to abutting property and has a right-of-way that exceeds twenty six feet (26') in width. The term street shall include avenue, drive, circle, road, parkway, boulevard, highway, thoroughfare or any other similar term.

**STREET, SUBCOLLECTOR:** A street which conveys traffic to more dwellings and includes through traffic between access streets and collectors. Usual ADT range is two hundred fifty (250) to one thousand (1,000) vehicles.

**STREETSCAPE:** The distinguishing characteristics of a particular street, including paving materials, adjacent space on both sides of the street, landscaping, retaining walls, sidewalks, building facades, lighting, medians, street furniture and signs.

**STRUCTURAL ALTERATIONS:** Any change in the supporting members of a building, such as bearing walls, columns, beams or girders.

**STRUCTURE:** Anything constructed, the use of which requires a fixed location on or in the ground, or attached to something having a fixed location on the ground and which imposes an impervious material on or above the ground; definition includes "building".

**STRUCTURE, PRE-EXISTING:** A structure, which was legally constructed prior to August 16, 2012.

**SUBDIVISION:**

- A. Any land that is divided, resubdivided or proposed to be divided into two (2) or more lots, parcels, sites, units, plots or other division of land for the purpose, whether immediate or future, for offer, sale, lease or development, either on the installment plan or upon any and all other plans, terms and conditions. Subdivision includes: 1) the division or development of land, whether by deed, metes and bounds description, devise and testacy, map, plat or other recorded instrument; and 2) divisions of land for residential and nonresidential uses, including land used or to be used for commercial, agricultural and industrial purposes.
- B. Subdivision does not include:
  1. A bona fide division or partition of agricultural land for the purpose of joining one of the resulting separate parcels to a contiguous parcel of unsubdivided agricultural land, if neither the resulting combined parcel nor the parcel remaining from the division or partition violates an applicable zoning

- ordinance;
2. A "lot line adjustment" that satisfies the applicable requirements of this title.
  3. A recorded document, executed by the owner of record, revising the legal description of more than one contiguous parcel of property into one legal description encompassing all such parcels of property, or joining a subdivided parcel of property to another parcel of property that has not been subdivided, so long as the joinder does not violate this title.

**SUBDIVISION PLAT:** The final map or drawing, on which the applicant's plan of subdivision is presented to the City Council for approval and which, if approved, may be submitted to the County Recorder for filing.

**SUBDIVISION, SIMPLE LOT:** Any subdivision containing not more than three (3) lots fronting on an existing street, not involving any new street, or the extension of Municipal facilities, or the creation of any public improvements, and not adversely affecting the remainder of the parcel or adjoining property, and not in conflict with any provision or portion of the General Plan, Official Land Use Map, Street Master Plan or these regulations. Subdivisions qualifying as a simple lot subdivision are exempt from the plat requirement.

**SURPLUS, SECONDHAND STORE:** An establishment that sells surplus items, used furniture, appliances, clothing and miscellaneous small items. Excluded from this definition are establishments selling used motor vehicles, their parts, military surplus and other heavy equipment.

**TECHNICAL NECESSITY:** A particular design, placement, construction or location of a telecommunications facility that is technically necessary for telecommunications consistent with the Federal Telecommunications Act of 1996, as amended.

**TELECOMMUNICATIONS:** The transmission, between or among points specified by a user, of information of the user's choosing, without change in the form or content of the information as sent or received.

**TELECOMMUNICATIONS FACILITY:** A telecommunications facility of more than thirty five feet (35') in height consisting of antenna, equipment shelters and related structures used for transmitting and/or receiving telecommunications and/or radio stations.

**TEMPORARY OUTDOOR USE:** A use, activity, vending cart, special event or commercial use outside that is not permanent in nature and after a seventy two (72) hour time period ceases or is removed.

**TEMPORARY USE:** A use, activity or special event that is not permanent in nature and after a designated time period ceases or is removed.

**THEATER, CONCERT HALL:** A building or amphitheater used primarily for the presentation of live stage productions or performances.

**TOBACCO/ELECTRONIC CIGARETTE (E-CIGARETTE) PRODUCT:**

- A. Any cigar, cigarette or electronic cigarette as defined in Utah Code § 76-10-101, as amended;
- B. A tobacco product as defined in Utah Code § 59-14-102, as amended, including:
  - 1. Chewing tobacco; or
  - 2. Any substitute for a tobacco product, including flavoring or additives to tobacco; and
- C. Tobacco paraphernalia as defined in Utah Code § 76-10-101 as amended.

**TOBACCO SPECIALTY BUSINESS, RETAIL:** A commercial establishment in which:

- A. The sale of tobacco products accounts for more than thirty five percent (35%) of the total annual gross receipts for the establishment;
- B. Food and beverage products, excluding gasoline sales, is less than forty five percent (45%) of the total annual gross receipts for the establishment;
- C. The establishment is not licensed as a pharmacy under Utah Code 58-17b, Pharmacy Practice Act; or Devotes twenty percent (20%) or more of floor area or display area to the sale or exchange of tobacco products and/or tobacco/e-cigarette paraphernalia;
- D. And as further defined by Utah Code § 10-8-41.6, as amended.

**TRAILER, TRAVEL:** See definition of recreational vehicle.

**TRANSFER STATION:** A facility designed for the transfer and transport of solid waste.

**TRAVEL PARK:** See definition of recreational vehicle park.

**UNINCORPORATED:** The area outside of the incorporated boundaries of cities and towns.

**USE:** The activities occurring on a lot or parcel of land for which land or a building is arranged, designed or intended, or for which land or a building is or may be occupied, including all accessory uses.

**USE, PRE-EXISTING:** A use, which validly existed prior to August 16, 2012, and has not been abandoned for more than six (6) months.

**UTILITIES:** Includes culinary water lines, pressure and gravity irrigation lines, sanitary and storm sewer lines, electric power, gas and telephone transmission lines, television cables, underground conduits and junction boxes.

**VENDING CART:** A small wheeled, nonmotorized vehicle from which to sell food and/or merchandise for immediate consumption or use.

**WAREHOUSE, COMMERCIAL:** An establishment primarily engaged in the storage and sale of goods to other firms for resale, as well as activities involving movement and storage of products or equipment. Typical uses include mail distribution centers, moving and storage firms, and warehousing and storage facilities.

**WELDING MACHINE SHOP:** A building or structure where pieces of metal are welded.

**YARD:** An open space on a lot, unoccupied and unobstructed from the ground upward.

**YARD, FRONT:** An open, unoccupied space, in the same lot with a building, between the front line of the main building and the street line and extending for the full width of the lot.

**YARD, REAR:** A yard extending across the full width of the lot between the most rear main building and the rear lot line. The depth of the required rear yard shall be measured horizontally from the nearest point of the rear lot line. On lots that are not rectangular in shape, the required minimum rear yard may be an average of the distances measured from the rear corners of the main building directly to the rear lot line.

**YARD, SIDE:** An open, unoccupied space, except as otherwise provided in this title, on the same lot with the building, between the side building wall and the side lot line, and extending from the front yard to the rear yard; or the shortest distance across said space from the main building to the side lot line.

**YOUTH HOME:** A twenty four (24) hour group living environment for three (3) to five (5) persons under the age of eighteen (18), unrelated to an owner or operator that offers room, board or specialized services to residents. Youth home may include facilities for the following: resource family home, child placement or residential support as defined in Utah Code 62A. Youth home shall not include facilities for the following: secure treatment, inpatient treatment, residential treatment, adult daycare, day treatment, comprehensive mental health treatment, youth program, comprehensive substance abuse treatment, or domestic violence treatment as defined in Utah Code 62A.

**YOUTH PROGRAM:**

- A. A nonresidential program, designed to provide behavioral, substance abuse or mental health services to minors that:
  - 1. Serves either adjudicated or nonadjudicated youth;
  - 2. Charges a fee for its services;
  - 3. May or may not provide host homes or other arrangements for overnight accommodation of the youth;
  - 4. May or may not provide all or part of its services in the outdoors;
  - 5. May or may not limit or censor access to parents or guardians; and
  - 6. Prohibits or restricts a minor's ability to leave the program at any time of his own free will.
- B. Youth program does not include recreational programs, such as Boy Scouts, Girl Scouts, 4-H and other such organizations.

**ZONING MAP:** A map, also known as a land use map, adopted as part of a land use ordinance that depicts land use zones, overlays or districts. (Ord. 18-277, 2-15-2018; amd. 2019 Code)

**SECTION 2:           ADOPTION** “18.64.190 Townhome Building Form And Development” of the Delta Municipal Code is hereby *added* as follows:

BEFORE ADOPTION

18.64.190 Townhome Building Form And Development (Non-existent)

AFTER ADOPTION

18.64.190 Townhome Building Form And Development(*Added*)

This section shall apply to any Two-Family Dwelling, Three-Family Dwelling, and Four-Family Dwelling that are intended to be subdivided as townhomes.

1. General Policy Statement: This Section shall be interpreted such that it is the intent that the subdivision of a townhome within Delta City results in each Townhome being self-servicing, meaning that each townhome will have sufficient, open-space (yard), access to utilities, off-street parking, each townhome having direct access to a public-right-of-way, etc.
2. Townhome dwellings are allowed in any zone a Two-Family Dwelling, Three-Family Dwelling, or Four-Family Dwelling would be allowed; meaning that a two-family dwelling townhome is an allowed use in a zone that a Two-family Dwelling is allowed, and same with a three or four-family dwelling.
3. Any and all requirements of Title 16 and 18 that would be applicable to any building for multi-family dwellings including, but not limited to the following, shall be applicable to townhome buildings:
  - a. Minimum lot size requirements shall be evaluated based on the total building and the number of residential units within the building.
  - b. Frontage requirements shall be evaluated based on the total width of all parcels, lots, or units located within a townhome building, not a individual residential unit within a townhome building.
  - c. Townhome buildings, and any number of dwelling units, are specially prohibited from fronting narrow right-of-way streets.
4. Each dwelling unit of a townhome building shall be considered its own residential unit for the purposes of minimum parking standards pursuant to [Delta City Code 18.64.050](#).
  - a. The minimum off street parking for each individual dwelling unit must be:
    - (1) Immediately accessible and front a public-right-of-way.
    - (2) Be located on the parcel or lot of the individual dwelling unit the parking is allocated to.
    - (3) Shared off-street parking between townhome units is prohibited.
5. Each structure shall have five-hundred (500) square feet of open space per dwelling unit with such open-space being located on the same parcel as the dwelling unit. The open space for the individual townhomes may be connected, but each town home



must satisfy its own open space requirement.

6. Metering and Equipment Placement:

a. Each townhome shall have individual and separate metering for all utility services.

b. Wall-mounted and ground-based meters, HVAC and utility equipment serving any building shall:

(1) be fully screened from view or located to the sides or rear of the building.

(2) be placed upon the lot or parcel of residential unity that it is servicing; and

(3) shall not be located on any facade on which a Townhome's primary entrance is located.

7. Circulation

a. Each building in which Townhomes are located shall include concrete sidewalks, at least four (4) feet in width, that connects each Townhome, to the right-of-way primarily used to access the Townhome, commonly owned amenity of the Townhome, and waste container to be utilized by the residents of the Townhome.

b. Public Right-of-Way Access:

(1) The Primary Façade of all Buildings shall front onto a public right-of-way.

(2) All townhome buildings shall be adjacent to and front a public street, and shall be located on lots to provide immediate access from public access from a public street and allow convenient access for fire and emergency access.

c. Conversion: Existing multi-family dwellings may be converted townhomes, provided that the proposed townhomes complies with all standards and requirements of this chapter, title, and applicable international building codes.

8. Each townhome shall have an identifiable transition between the individual units.

**SECTION 3: AMENDMENT “18.64.180 Multiple-Family Dwellings” of the Delta Municipal Code is hereby *amended* as follows:**

**BEFORE AMENDMENT**

18.64.180 Multiple-Family Dwellings

This section shall apply to any Two-Family Dwelling, Three-Family Dwelling, and Four-Family Dwelling.

A. Open Space requirement. Five-hundred (500) square foot of open space per dwelling unit.

AFTER AMENDMENT

18.64.180 Multiple-Family Dwellings

This section shall apply to any Two-Family Dwelling, Three-Family Dwelling,, and Four-Family Dwelling.

A. Open Space requirement. Five-hundred (500) square foot of open space per dwelling unit.

B. Required Amenities

1. Aa a minimum, each dwelling unit must include the following amenities:
  - a. Location and necessary plumbing;
  - b. Enhanced soundproofing;
  - c. Location, plumbing, and appliance of a dishwasher in the kitchen.

C. Landscaping Requirements.

1. At a minimum, Landscaping is required in all yard areas, along the perimeter of parking areas, in front of buildings, and in the front setback of any improved property not used for parking, driveways, walkways, and any required open-space.
2. Front yard and corner side yard landscaped areas shall be landscaped with suitable grass, trees, shrubs, groundcovers, perennials, or other Landscaping materials.
3. Site Trees. A minimum of two (2) trees per 1,000 square feet of Landscaped Area is required, in addition to requirements for Yards, Setbacks, Park Strips, required Buffers, and Parking Areas described in this Chapter.
4. If ornamental gravel is utilized, it must be contained within durable borders or landscaped edging.
5. Irrigation. Permanent irrigation systems are required.

**SECTION 4:            AMENDMENT “18.16.010 USE TABLE”** of the Delta Municipal Code is hereby *amended* as follows:

BEFORE AMENDMENT

18.16.010 USE TABLE

The following Use Table is to establish the permitted uses within the designated zones of Delta City. If the use is not specifically designated as allowed as contained in the Use Table, then it is prohibited.

Use Type	A-1	A-5	R-1-A	R-1-B	R-2	R-4	R-R	R-R-2	L-R-R	M-H	C-B	H-C	I-1	P/Q/P

Accessory unit, occupied	X	X					X	X						
Accessory structure, unoccupied	X	X	X	X	X	X	X	X		X	X	X	X	X
Adult oriented business													X	
Agriculture	X	X											X	
Agriculture (if lot is 1 or greater)							X	X						
Agriculture industry	X	X										X	X	
Animal Hospital	X	X											X	
Athletic club	X	X				X					X	X	X	
Auto self serve station											X	X	X	
Auto service station											X	X	X	
Auto truck, RV sales and rental											X	X	X	
Automotive body/paint repair establishment											X	X	X	
Automotive repair establishment											X	X	X	
Aviation airport - accessory living quarters														X
Aviation airport - services													X	X
Banking - financial services											X	X		
Bar, tavern, lounge											X	X		
Bed and breakfast	X	X									X	X		
Business, commercial, less intensive	X	X									X	X	X	

Business, retail (limited, inside e.g., C-store, specialty, repair shops etc.)						X					X	X	X	
Business, service (limited, inside e.g., professional office, dental/medical clinic)						X					X	X	X	
<b>Use Type</b>	<b>A-1</b>	<b>A-5</b>	<b>R-1-A</b>	<b>R-1-B</b>	<b>R-2</b>	<b>R-4</b>	<b>R-R</b>	<b>R-R-2</b>	<b>L-R-R</b>	<b>M-H</b>	<b>C-B</b>	<b>H-C</b>	<b>I-1</b>	<b>P/Q P</b>
Cemetery														X
Child care for business center: 8 children or less	X	X	X	X	X	X	X	X		X	X			
Child care for business facility: 9 children or more	X	X				X	X	X			X			
Church	X	X					X	X			X	X		X
Church (forty feet (40') from all property lines, no residence within)			X	X	X	X								
Church, accessory living quarters														
Cinema, indoor											X	X	X	
Civic club	X	X	X			X	X	X			X	X	X	
Coal yard													X	
Community facilities (dance studio, private school, etc.)						X					X	X	X	X
Condominium														
Convenience goods - sales											X	X	X	

Cultural, civic services											X			X
Dry cleaning establishment											X	X	X	
Dwelling, four family						X								
Dwelling, single-family	X	X	X	X	X	X	X	X	X	X				
Dwelling, three family						X								
Dwelling, two family					X	X								
Farm animals/livestock	X	X										X	X	
Farm animals/livestock (non-commercial uses)	X	X					X	X						
<b>Use Type</b>	<b>A-1</b>	<b>A-5</b>	<b>R-1-A</b>	<b>R-1-B</b>	<b>R-2</b>	<b>R-4</b>	<b>R-R</b>	<b>R-R-2</b>	<b>L-R-R</b>	<b>M-H</b>	<b>C-B</b>	<b>H-C</b>	<b>I-1</b>	<b>P/Q P</b>
Fence, corner lot	X	X												
Fence, electric	X	X					X	X					X	
Fence, wildlife/large animal	X	X					X	X				X	X	X
Fencing														
Fireworks sales/stands											X	X	X	
General merchandise sales and services											X	X	X	
Group home, assisted living facility	X		X		X	X	X	X						
Group home, disabled	X		X		X	X	X	X						

Group home, elderly	X		X	X	X	X	X	X						
Health care center											X	X		X
Heavy/farm equipment sales	X	X									X	X	X	
Home occupation	X	X	X	X	X	X	X	X		X				
Hospital											X	X		X
Hotel											X	X		
Household pets (less than or equal to 3)	X	X	X	X	X	X	X	X		X	X	X	X	
Industrial park													X	
Industry, medium													X	
Kennel (more than 3 pets)	X	X											X	
Laundromat										X	X	X		
Laundry										X	X	X		
<b>Use Type</b>	<b>A-1</b>	<b>A-5</b>	<b>R-1-A</b>	<b>R-1-B</b>	<b>R-2</b>	<b>R-4</b>	<b>R-R</b>	<b>R-R-2</b>	<b>L-R-R</b>	<b>M-H</b>	<b>C-B</b>	<b>H-C</b>	<b>I-1</b>	<b>P/Q/P</b>
Light industry												X	X	
Liquor store											X			
Lumber sales - storage	X	X									X	X	X	
Mental health center											X	X		X
Military surplus store											X	X	X	
Mobile home										X				
Mobile home park										X				
Modular home										X				
Mortuary						X					X	X	X	
Motel											X	X		

Nursery											X	X	X	
Nursery (including retail sales)	X	X												
Nursery (personal use)	X	X												
Office, business, government											X	X		X
Office, professional											X	X		
Outdoor recreation - park - play	X	X					X	X		X	X			X
Pawn shops											X	X	X	
Personal services						X		X			X	X		
Pet grooming											X	X		
Preschool	X	X	X	X			X	X			X			X
<b>Use Type</b>	<b>A-1</b>	<b>A-5</b>	<b>R-1-A</b>	<b>R-1-B</b>	<b>R-2</b>	<b>R-4</b>	<b>R-R</b>	<b>R-R-2</b>	<b>L-R-R</b>	<b>M-H</b>	<b>C-B</b>	<b>H-C</b>	<b>I-1</b>	<b>P/Q</b> <b>P</b>
Preschool (play area enclosed by fence approved by Code Enforcement Officer)					X									
Preschool (play area enclosed on all sides by four feet (4') fence)						X								
Public - rights-of-way	X	X	X	X	X	X	X	X		X	X	X	X	X
Public services			X	X	X	X	X	X			X	X	X	X
Public utilities - except sewer							X	X			X	X	X	
Public utility stations	X	X											X	X

Recreational activity specialties													X	
Recreational vehicle park										X		X		
Repair services, small app											X	X	X	
Restaurant, cafe											X	X		
Restaurant, fast food											X	X		
Restaurant (limited, no drive through service)						X								
School, public							X	X				X	X	X
School, public (forty feet (40') from all property lines, no residence within)			X	X	X	X								
Schools, private, quasi-public							X	X				X	X	X
Schools, private, quasi-public (forty feet (40') from all property lines, no residence within)			X	X	X	X								
Shopping center - community												X	X	
Skating - rollerboard park												X	X	
Small engine repair	X	X					X	X				X	X	X
Solar energy system	X	X	X	X	X	X	X	X	X	X	X	X	X	X
<b>Use Type</b>	<b>A-1</b>	<b>A-5</b>	<b>R-1-A</b>	<b>R-1-B</b>	<b>R-2</b>	<b>R-4</b>	<b>R-R</b>	<b>R-R-2</b>	<b>L-R-R</b>	<b>M-H</b>	<b>C-B</b>	<b>H-C</b>	<b>I-1</b>	<b>P/Q/P</b>
Stable, public													X	



Stables, private							X	X					
Stables, private (provided structures housing animals shall not be closer than two-hundred feet (200') to any property line)	X	X											
Stables, public (provided structures housing animals shall not be closer than two-hundred feet (200') to any property line)	X	X											
Stables, public/commercial								X					
Storage container	X	X						X				X	
Storage unit - commercial											X	X	
Subdivision			X	X	X	X	X	X		X	X	X	
Surplus, secondhand store										X	X		
Telecommunication s facility < Thirty-Five Feet (35') height										X	X	X	
Telecommunication s facility < Two-Hundred feet (200') height											X	X	X
Temporary outdoor use										X	X	X	
Tobacco specialty business, retail										X		X	
Theatre, concert hall										X	X		X

Warehouse - commercial												X	X	
Welding machine shop													X	

AFTER AMENDMENT

18.16.010 USE TABLE

The following Use Table is to establish the permitted uses within the designated zones of Delta City. If the use is not specifically designated as allowed as contained in the Use Table, then it is prohibited.

Use Type	A-1	A-5	R-1-A	R-1-B	R-2	R-4	R-R	R-R-2	L-R-R	M-H	C-B	H-C	I-1	P/QP
Accessory unit, occupied	X	X			X	X	X	X						
Accessory structure, unoccupied	X	X	X	X	X	X	X	X	X	X	X	X	X	X
Adult oriented business													X	
Agriculture	X	X											X	
Agriculture (if lot is 1 or greater)							X	X						
Agriculture industry	X	X										X	X	
Animal Hospital	X	X											X	
Athletic club	X	X				X					X	X	X	
Auto self serve station											X	X	X	
Auto service station											X	X	X	
Auto truck, RV sales and rental											X	X	X	
Automotive body/paint repair											X	X	X	

establishment														
Automotive repair establishment											X	X	X	
Aviation airport - accessory living quarters														X
Aviation airport - services													X	X
Banking - financial services											X	X		
Bar, tavern, lounge											X	X		
Bed and breakfast	X	X									X	X		
Business, commercial, less intensive	X	X									X	X	X	
Business, retail (limited, inside e.g., C-store, specialty, repair shops etc.)						X					X	X	X	
Business, service (limited, inside e.g., professional office, dental/medical clinic)						X					X	X	X	
<b>Use Type</b>	<b>A-1</b>	<b>A-5</b>	<b>R-1-A</b>	<b>R-1-B</b>	<b>R-2</b>	<b>R-4</b>	<b>R-R</b>	<b>R-R-2</b>	<b>L-R-R</b>	<b>M-H</b>	<b>C-B</b>	<b>H-C</b>	<b>I-1</b>	<b>P/QP</b>
Cemetery														X
Child care for business center: 8 children or less	X	X	X	X	X	X	X	X		X	X			
Child care for business facility: 9 children or more	X	X				X	X	X			X			
Church	X	X					X	X			X	X		X
Church (forty feet (40') from all														

property lines, no residence within)			X	X	X	X								
Church, accessory living quarters														
Cinema, indoor											X	X	X	
Civic club	X	X	X			X	X	X			X	X	X	
Coal yard													X	
Community facilities (dance studio, private school, etc.)						X					X	X	X	X
Condominium														
Convenience goods - sales											X	X	X	
Cultural, civic services											X			X
Dry cleaning establishment											X	X	X	
Dwelling, four family						X								
Dwelling, single-family	X	X	X	X	X	X	X	X	X	X				
Dwelling, three family						X								
Dwelling, two family					X	X								
<a href="#">Dwelling, townhome (See 18.64.190 for allowed zones)</a>														
Farm animals/livestock	X	X										X	X	
Farm animals/livestock (non-commercial uses)	X	X					X	X						

Use Type	A-1	A-5	R-1-A	R-1-B	R-2	R-4	R-R	R-R-2	L-R-R	M-H	C-B	H-C	I-1	P/QP
Fence, corner lot	X	X												
Fence, electric	X	X					X	X					X	
Fence, wildlife/large animal	X	X					X	X				X	X	X
Fencing														
Fireworks sales/stands											X	X	X	
General merchandise sales and services											X	X	X	
Group home, assisted living facility	X		X		X	X	X	X						
Group home, disabled	X		X		X	X	X	X						
Group home, elderly	X		X	X	X	X	X	X						
Health care center											X	X		X
Heavy/farm equipment sales	X	X									X	X	X	
Home occupation	X	X	X	X	X	X	X	X		X				
Hospital											X	X		X
Hotel											X	X		
Household pets (less than or equal to 3)	X	X	X	X	X	X	X	X		X	X	X	X	
Industrial park													X	
Industry, medium													X	
Kennel (more than 3 pets)	X	X											X	
Laundromat										X	X	X		

Laundry										X	X	X		
<b>Use Type</b>	<b>A-1</b>	<b>A-5</b>	<b>R-1-A</b>	<b>R-1-B</b>	<b>R-2</b>	<b>R-4</b>	<b>R-R</b>	<b>R-R-2</b>	<b>L-R-R</b>	<b>M-H</b>	<b>C-B</b>	<b>H-C</b>	<b>I-1</b>	<b>P/QP</b>
Light industry												X	X	
Liquor store											X			
Lumber sales - storage	X	X									X	X	X	
Mental health center											X	X		X
Military surplus store											X	X	X	
Mobile home										X				
Mobile home park										X				
Modular home										X				
Mortuary						X					X	X	X	
Motel											X	X		
Nursery											X	X	X	
Nursery (including retail sales)	X	X												
Nursery (personal use)	X	X												
Office, business, government											X	X		X
Office, professional											X	X		
Outdoor recreation - park - play	X	X					X	X		X	X			X
Pawn shops											X	X	X	
Personal services						X		X			X	X		
Pet grooming											X	X		
Preschool	X	X	X	X			X	X			X			X
			<b>R-</b>	<b>R-</b>			<b>R-</b>	<b>R-</b>	<b>L-</b>	<b>M-</b>	<b>C-</b>	<b>H-</b>		<b>P/</b>

Use Type	A-1	A-5	1-A	1-B	R-2	R-4	R	R-2	R-R	H	B	C	I-1	QP
Preschool (play area enclosed by fence approved by Code Enforcement Officer)					X									
Preschool (play area enclosed on all sides by four feet (4') fence)						X								
Public - rights-of- way	X	X	X	X	X	X	X	X		X	X	X	X	X
Public services			X	X	X	X	X	X			X	X	X	X
Public utilities - except sewer							X	X			X	X	X	
Public utility stations	X	X											X	X
Recreational activity specialties													X	
Recreational vehicle park										X		X		
Repair services, small app											X	X	X	
Restaurant, cafe											X	X		
Restaurant, fast food											X	X		
Restaurant (limited, no drive through service)						X								
School, public							X	X			X	X		X
School, public (forty feet (40') from all property lines, no residence within)			X	X	X	X								

Schools, private, quasi-public							X	X			X	X		X
Schools, private, quasi-public (forty feet (40') from all property lines, no residence within)			X	X	X	X								
Shopping center - community											X	X		
Skating - rollerboard park											X	X		
Small engine repair	X	X					X	X			X	X	X	
Solar energy system	X	X	X	X	X	X	X	X	X	X	X	X	X	X
<b>Use Type</b>	<b>A-1</b>	<b>A-5</b>	<b>R-1-A</b>	<b>R-1-B</b>	<b>R-2</b>	<b>R-4</b>	<b>R-R</b>	<b>R-R-2</b>	<b>L-R-R</b>	<b>M-H</b>	<b>C-B</b>	<b>H-C</b>	<b>I-1</b>	<b>P/QP</b>
Stable, public													X	
Stables, private							X	X						
Stables, private (provided structures housing animals shall not be closer than two-hundred feet (200') to any property line)	X	X												
Stables, public (provided structures housing animals shall not be closer than two-hundred feet (200') to any property line)	X	X												
Stables, public/commercial								X						
Storage container	X	X						X					X	
Storage unit -														



commercial												X	X	
Subdivision			X	X	X	X	X	X		X	X	X		
Surplus, secondhand store											X	X		
Telecommunication s facility < Thirty-Five Feet (35') height											X	X	X	
Telecommunication s facility < Two-Hundred feet (200') height												X	X	X
Temporary outdoor use											X	X	X	
Tobacco specialty business, retail											X		X	
Theatre, concert hall											X	X		X
Warehouse - commercial												X	X	
Welding machine shop													X	

**SECTION 5: REPEALER CLAUSE** All ordinances or resolutions or parts thereof, which are in conflict herewith, are hereby repealed.

**SECTION 6: SEVERABILITY CLAUSE** Should any part or provision of this Ordinance be declared by the courts to be unconstitutional or invalid, such decision shall not affect the validity of the Ordinances a whole or any part thereof other than the part so declared to be unconstitutional or invalid.

**SECTION 7: EFFECTIVE DATE** This Ordinance shall be in full force and effect from after the required approval and publication according to law.

PASSED AND ADOPTED BY THE DELTA CITY COUNCIL

\_\_\_\_\_.

	<b>AYE</b>	<b>NAY</b>	<b>ABSENT</b>	<b>ABSTAIN</b>
Robert W. Banks	_____	_____	_____	_____
Brett C. Bunker	_____	_____	_____	_____
Kiley J. Chase	_____	_____	_____	_____
Nicholas W. Killpack	_____	_____	_____	_____
Betty Jo Western	_____	_____	_____	_____
Presiding Officer		Attest		

\_\_\_\_\_  
John W. Niles, Mayor, Delta City

\_\_\_\_\_  
Sherri Westbrook, City Recorder,  
Delta City